

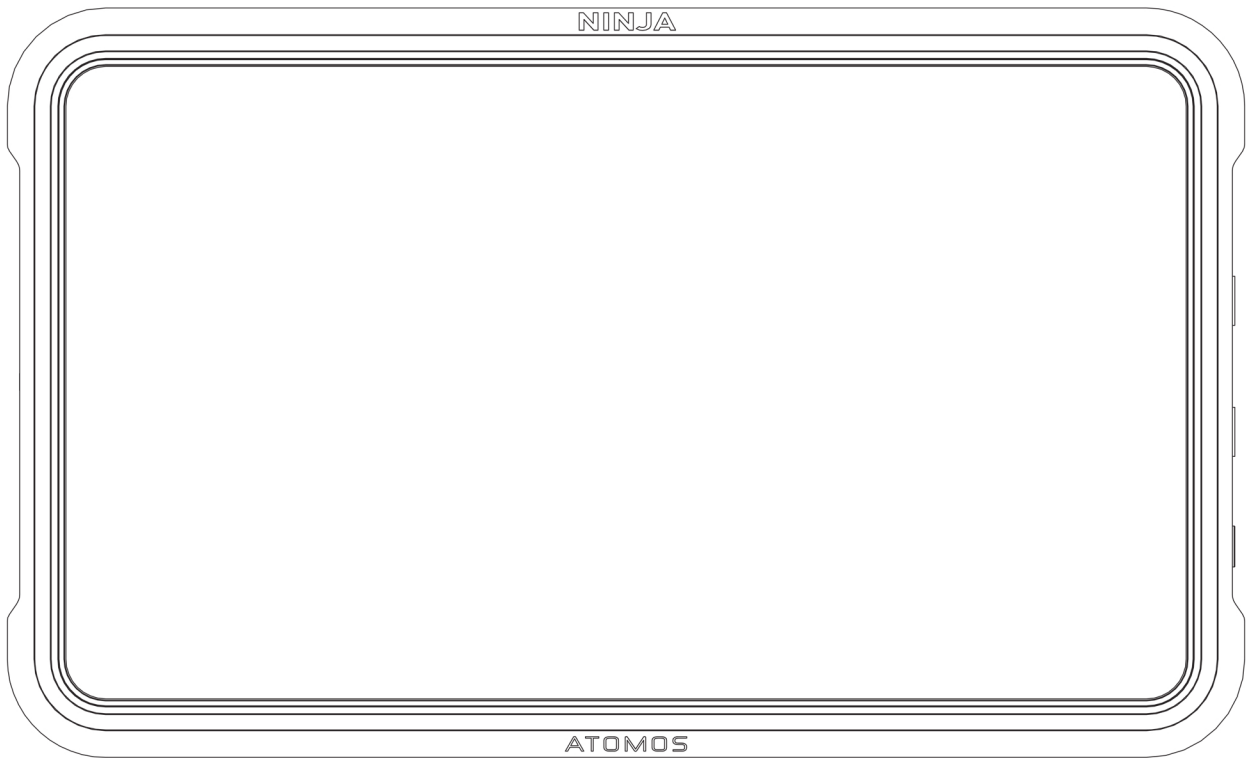

# NINJA V

USER MANUAL



# NINJA V User Manual

© ATOMOS 2022. TM ®All trademarks and registered trademarks are the property of their respective owners.

Specifications are subject to change without notice. All information assumed correct at time of publishing.



*This user manual assumes that you are using AtomOS firmware version 10.82 or later. Visit [my.atomos.com](https://my.atomos.com) to update the AtomOS firmware for your NINJA V*

## Contents

---

<b>NINJA V User Manual</b> .....	<b>1</b>
<b>Introduction</b> .....	<b>6</b>
<b>Safety Instructions</b> .....	<b>7</b>
<b>Software License Agreement</b> .....	<b>9</b>
<b>Registering your product</b> .....	<b>11</b>
<b>International Hardware Limited Warranty</b> .....	<b>12</b>
<b>Warranty Exclusions</b> .....	<b>13</b>
<b>User Manual Conventions</b> .....	<b>14</b>
<b>What's included</b> .....	<b>15</b>
<b>NINJA V Connections</b> .....	<b>16</b>
<b>Best Practice</b> .....	<b>19</b>
<b>HDMI cables</b> .....	<b>31</b>
<b>Media</b> .....	<b>32</b>
<b>Master Caddy Docking Station</b> .....	<b>35</b>
<b>Standard 1/4" or 3/8" Mount/Arm</b> .....	<b>37</b>
<b>Mounting options</b> .....	<b>38</b>
<b>Choosing your power source</b> .....	<b>39</b>
<b>Powering On and Off</b> .....	<b>43</b>
<b>Inserting and Removing Media</b> .....	<b>45</b>
<b>Mounting disks in the Master Caddy II</b> .....	<b>47</b>
<b>Mounting Disks in Master Caddy III</b> .....	<b>49</b>
<b>AtomX Expansion Modules</b> .....	<b>52</b>
<b>ATOMOS CONNECT</b> .....	<b>57</b>
<b>AtomOS 10 Operating System</b> .....	<b>73</b>
<b>The Main Screen - Home Screen</b> .....	<b>74</b>
<b>The Main Screen - Information Bar</b> .....	<b>76</b>
<b>The Main Screen - Monitoring Features</b> .....	<b>79</b>
<b>Home screen and menu functions</b> .....	<b>81</b>
<b>The NINJA V Menu system</b> .....	<b>86</b>
<b>Source Menu</b> .....	<b>87</b>
<b>Input Source</b> .....	<b>89</b>
<b>Input via AtomX SDI Expansion Module</b> .....	<b>91</b>

---

<b>Input via Atomos CONNECT</b> .....	<b>93</b>
<b>Trigger</b> .....	<b>95</b>
<b>Device</b> .....	<b>96</b>
<b>Remote</b> .....	<b>97</b>
<b>Camera Output</b> .....	<b>102</b>
<b>Cross Conversion</b> .....	<b>105</b>
<b>Output Menu</b> .....	<b>107</b>
<b>Output via AtomX SDI Expansion Module</b> .....	<b>110</b>
<b>Record Menu</b> .....	<b>112</b>
<b>RAW over HDMI</b> .....	<b>116</b>
<b>SDI RAW</b> .....	<b>117</b>
<b>Sony Metadata Crop</b> .....	<b>118</b>
<b>Pulldown</b> .....	<b>119</b>
<b>H.265 (HEVC)</b> .....	<b>122</b>
<b>Wi-Fi Menu</b> .....	<b>123</b>
<b>Ethernet Menu</b> .....	<b>128</b>
<b>Connect Menu</b> .....	<b>132</b>
<b>Connect Menu - Atomos Cloud Studio</b> .....	<b>144</b>
<b>Connect Menu - Capture to Cloud</b> .....	<b>146</b>
<b>Connect Menu - Atomos Stream</b> .....	<b>161</b>
<b>Timelapse Menu</b> .....	<b>192</b>
<b>Timecode Menu</b> .....	<b>197</b>
<b>Timecode Menu - Wireless Timecode &amp; Sync</b> .....	<b>201</b>
<b>Sync Config Menu</b> .....	<b>205</b>
<b>Sync Network Menu</b> .....	<b>209</b>
<b>File Menu</b> .....	<b>210</b>
<b>Audio Menu</b> .....	<b>213</b>
<b>Mic/Line Menu</b> .....	<b>216</b>
<b>Media Menu</b> .....	<b>218</b>
<b>Date Menu</b> .....	<b>220</b>
<b>Power Menu</b> .....	<b>221</b>
<b>Activation Menu</b> .....	<b>224</b>

---

<b>AtomX Menu</b> .....	<b>230</b>
<b>Info Menu</b> .....	<b>233</b>
<b>The AtomRemote App</b> .....	<b>235</b>
<b>Connecting to AtomRemote</b> .....	<b>236</b>
<b>Using the AtomRemote app</b> .....	<b>243</b>
<b>AtomRemote - Input, Monitor and Output</b> .....	<b>253</b>
<b>AtomRemote - Record menu</b> .....	<b>261</b>
<b>AtomRemote - Monitor Assist Settings</b> .....	<b>263</b>
<b>Using the AtomX CAST</b> .....	<b>265</b>
<b>Attaching AtomX CAST to your NINJA V</b> .....	<b>266</b>
<b>Powering the AtomX CAST</b> .....	<b>267</b>
<b>Connecting the AtomX CAST to your Computer</b> .....	<b>268</b>
<b>CAST - Main Screen</b> .....	<b>269</b>
<b>CAST - Function Icons F1- F4</b> .....	<b>272</b>
<b>CAST - Input Menu</b> .....	<b>275</b>
<b>CAST - Output menu</b> .....	<b>277</b>
<b>CAST - Overlays menu</b> .....	<b>279</b>
<b>CAST - Picture in Picture (PiP) menu</b> .....	<b>282</b>
<b>CAST - Switcher Menu</b> .....	<b>284</b>
<b>CAST - Audio menu</b> .....	<b>287</b>
<b>Setting up for recording</b> .....	<b>290</b>
<b>SmartControl</b> .....	<b>292</b>
<b>Understanding HDR and Log</b> .....	<b>294</b>
<b>File Recovery</b> .....	<b>297</b>
<b>Monitoring Features</b> .....	<b>298</b>
<b>Zoom</b> .....	<b>301</b>
<b>Waveform (WFM) and Vectorscope</b> .....	<b>302</b>
<b>Focus Peaking, Zebra and False Color</b> .....	<b>305</b>
<b>Frame Guides, Safe Areas &amp; Anamorphic De-Squeeze</b> .....	<b>308</b>
<b>Frame Grab and Onion Skin</b> .....	<b>312</b>
<b>Settings Menu</b> .....	<b>315</b>
<b>Waveform tab</b> .....	<b>316</b>

---

<b>Focus Peaking tab</b> .....	<b>317</b>
<b>Zebra tab</b> .....	<b>320</b>
<b>LUTs tab</b> .....	<b>321</b>
<b>Monitor tab</b> .....	<b>327</b>
<b>Display tab</b> .....	<b>331</b>
<b>Frame Guide tab</b> .....	<b>333</b>
<b>Onion Skin tab</b> .....	<b>335</b>
<b>Playback mode</b> .....	<b>336</b>
<b>Playlists</b> .....	<b>341</b>
<b>Video Format menu</b> .....	<b>345</b>
<b>Playback - Output Menu</b> .....	<b>347</b>
<b>Playback - Audio menu</b> .....	<b>348</b>
<b>Edit Mode</b> .....	<b>349</b>
<b>Markers and Tagging Icons (SmartLog)</b> .....	<b>352</b>
<b>Using Edit tools during recording, playback and monitoring</b> .....	<b>356</b>
<b>Using Extended Tags</b> .....	<b>359</b>
<b>Exporting Tags</b> .....	<b>360</b>
<b>Connecting media</b> .....	<b>361</b>
<b>Importing clips</b> .....	<b>364</b>
<b>SmartLog with Final Cut Pro</b> .....	<b>370</b>
<b>Adjusting ProRes RAW settings in Final Cut Pro</b> .....	<b>373</b>
<b>Technical Specifications</b> .....	<b>377</b>

# Introduction

Thank you for choosing the ATOMOS NINJA 5 inch 4Kp60 HDR Monitor Recorder. Featuring a super high-resolution screen in a lightweight aluminium alloy chassis, and an array of essential production tools including waveform monitoring, vectorscope, focus assist and the world's leading support for HDR monitoring; NINJA V will give you the creative and commercial advantage you've been looking for.

With NINJA V you can record up to 6Kp30 in Apple ProRes RAW, and 4Kp60 and HDp120 video, and integrate these new formats seamlessly into the timeline of your existing ProRes RAW or ProRes projects. Rounding out the powerful codec arsenal is Apple ProRes, Avid DNx as well as the option to upgrade to H.265, which provides a highly efficient compressed codec option.

This user manual will get you up to speed with all the amazing features packed into the NINJA V that will assist you during a shoot and speed up your workflow on set and in post production.

Stay up-to-date with the latest information and software by registering your product today at [my.atomos.com](https://my.atomos.com)

Visit [www.atomos.com/support](https://www.atomos.com/support) to learn about supported cameras and media, read FAQ's, submit support tickets and more.

# Safety Instructions

The NINJA V is designed to a high standard but there are some things you should be aware of to prolong the life of the unit and for your own safety.

## Using the NINJA V safely

Although the NINJA V is very lightweight compared to all the devices it replaces, it is still a solid object that could cause injury if misused.

- Always make sure that the NINJA V is mounted securely and is unable to fall onto anyone nearby. This is especially important when there are children present who might be tempted to pull on cables.
- Always ensure that cables that run to the NINJA V are clearly visible and do not present a trip hazard.
- Do not place on uneven or unstable surfaces.
- Do not insert anything but a NINJA V Master Caddy II or AtomX SSDmini in the drive slot on the rear of the NINJA V.
- Do not touch the NINJA V screen with sharp, metallic or abrasive objects.
- Do not expose to strong electrical or magnetic fields.
- Do not expose to liquids, rain or moisture.
- Do not dispose of the NINJA V in municipal waste and do not incinerate it, always follow local regulations for safe disposal.

## Care of disk drives

Spinning disks and SSDs are very sensitive to damage from static electricity. Please observe all the usual electrostatic discharge (ESD) precautions when handling them. Please see the section on mechanical shock and vibration later in this manual for information about how to handle and care for your disk drives



## HDMI cables



*Please remember that almost all HDMI cables do not use locking connectors and will simply pull out if they are jerked or tripped over. Please ensure your cables make a secure connection and avoid flexing them excessively to maintain reliability.*

# Software License Agreement

IMPORTANT, PLEASE READ CAREFULLY. THIS IS A LICENSE AGREEMENT.

This ATOMOS software, related documentation, any included sample images files (the "Software"), is protected by copyright laws and international copyright treaties, as well as other intellectual property laws and treaties. The Software is licensed, not sold.

This End User License Agreement ("EULA") is a legal agreement between you (either an individual or a single entity) and ATOMOS with regard to the copyrighted Software provided with this EULA. Use of the Software provided to you by ATOMOS in whatever form or media, will constitute your acceptance of these terms, unless separate terms are provided by the software supplier, in which case certain additional or different terms may apply. If you do not agree with the terms of this EULA, do not download, install copy or use the Software. By installing, copying or otherwise using the Software, you agree to be bound to the terms of this EULA. If you do not agree to the terms of this EULA, ATOMOS is unwilling to license the Software to you.

1. Eligible licensees. This Software is available for license solely to purchasers of the ATOMOS NINJA V, who have purchased a unit manufactured by ATOMOS NINJA V and purchased through an ATOMOS authorized reseller, with no right of duplication or further distribution, licensing or sub-licensing.
2. License Grant. ATOMOS grants you a personal, non-transferable and non-exclusive right to use the copy of the Software provided with this EULA. You agree you will not copy the Software except as necessary to use it with the ATOMOS NINJA V. You agree that you may not copy the written materials accompanying the Software. Modifying, reverse engineering, translating, renting, copying, transferring or assigning all or part of the Software or any rights granted hereunder, to any other persons or reverse engineering the hardware on which the Software runs, is strictly prohibited. The software is licensed, not sold. You acknowledge that no title to intellectual property in the Software is transferable to you. You further acknowledge that title and full ownership rights to the Software will remain the exclusive property of ATOMOS and/or its suppliers, and you will not acquire any rights to the Software, except as expressly set forth above. All copies of the software will contain the same proprietary notices as contained in or on the Software. All title and copyrights in and to the Software (including but not limited to any images, animations, video, audio, text incorporated), the accompanying printed materials, and any copies of the Software are owned by ATOMOS or its suppliers.
3. Reverse engineering. You agree that you will not attempt, and if you are a corporation, you will use your best effort to prevent your employees and contractors from attempting to reverse compile, derive circuits, modify, translate or disassemble the Software and/or the ATOMOS NINJA V in whole or in part. Any failure to comply with the above or any other terms and conditions contained herein will result in the automatic termination of this license and the reversion of the rights granted

hereunder by ATOMOS.

ATOMOS reserves the right to terminate this license without prejudice to any additional recourse ATOMOS may have against you if you violate any of its terms and conditions.

## Notice

Copyright © 2022 ATOMOS Global Pty Ltd ('referred to as ATOMOS'). All rights reserved. All information in this document is subject to change without notice. No part of the document may be reproduced or transmitted in any form, or by any means, electronic or mechanical, including photocopying or recording, without the express written permission of ATOMOS. A reference to ATOMOS includes its related entities, subsidiaries and parent company.

Image credit on NINJA V display and all other instances: <https://unsplash.com/@freestocks>

## Trademarks

NINJA V and ATOMOS are registered trademarks of ATOMOS. Apple, the Apple logo, AppleShare, AppleTalk, iPod, iPod Touch, Mac, and Macintosh are registered trademarks of Apple Inc. Final Cut Pro, QuickTime and the QuickTime Logo are trademarks of Apple Inc. DNxHD, DNxHR and Avid logo are registered trademarks of Avid Technology, Inc. All other trademarks are the property of their respective holders.

REGISTRATION + WARRANTY UPGRADE Register within 12 months of purchase date to upgrade your standard 1 year warranty to a 3 year warranty. Visit: [my.atomos.com](http://my.atomos.com).

Registered users receive updates of all AtomOS updates upon release.

## Registering your product

Register your NINJA V at [my.atomos.com](https://my.atomos.com) within twelve months of purchase to upgrade to a 3 year warranty.

Registering your product ensures you receive communication on all future updates.

# International Hardware Limited Warranty

ATOMOS warrants that:

- The main product, not including the IPS screen, or any external accessories, will be free from defects in materials and workmanship for a period of 1 year from the date of purchase; or 3 years upon completion of product registration within 1 year from the date of purchase at [www.atomos.com](http://www.atomos.com)
- The TFT/LCD, SSD Docking Station, Master Caddy II and Cable will be free from defects in materials and workmanship for a period of 1 year from the date of purchase.
- This warranty is exclusively for the benefit of the original purchaser and is not assignable or transferable.
- If during the warranty period the product is shown to be defective ATOMOS may at its option:
  - a. Replace the goods or supply equivalent ones,
  - b. Repair the goods,
  - c. Pay the cost of replacing the goods or of acquiring equivalent ones and
  - d. Paying the cost of having the goods repaired;

The customer must notify ATOMOS of any defect in the goods in writing prior to the expiry of the warranty periods set out above. The customer will be solely responsible for returning the goods to ATOMOS or its authorized distributor. Upon acceptance of a warranty claim by ATOMOS, where ATOMOS repairs or replaces the goods, it will be responsible for reasonable shipping costs incurred in sending the goods to the Customer, provided that customer is located in a country in which ATOMOS has an authorized distributor or repair center or agent.

## Warranty Exclusions

This warranty applies only to defects in workmanship and does not cover defects caused by:

- Neglect;
- Improper or negligent acts or omissions;
- Repairs or attempted repairs;
- Tampering with or modification of the goods;
- Connection to incompatible equipment or power sources;
- Exposure to water or weather;
- Exposure to magnetic fields or corrosive liquids or substances;
- Physical damage

Except as stated in this warranty, ATOMOS, its vendors, agents, resellers and distributors disclaim in their entirety all other warranties, express or implied, including without limitation all warranties of merchantability or fitness for a particular purpose. The remedies outlined in this warranty are the exclusive remedy a customer from defective goods, which are subject to the warranty.

ATOMOS does not warrant that the goods will operate in a manner that is error free, or uninterrupted. The goods are not intended to be the primary or only data storage device for data – customers are solely responsible for back up and protection of data.

REGISTRATION + WARRANTY UPGRADE Register within 12 months of purchase date to upgrade your standard 1 year warranty to a 3 year warranty. Visit: [my.atomos.com](http://my.atomos.com).

Registered users receive updates of all AtomOS updates upon release.

# User Manual Conventions

To keep things simple but clear, we've only adopted two conventions in this manual



*A helpful tip, suggestion or something to note because it's not obvious at first.*



*An important note or warning*

## What's included

Your NINJA V includes base accessories to get you started, such as a mains power supply and a media Master Caddy. Additionally you will need a 2.5" Solid State Drive (SSD) or AtomX SSDmini, a compatible HDMI cable (Camera out/NINJA V in) and compatible batteries. Optional AtomX accessories including power and accessory kits are also available. Visit the ATOMOS website for the latest accessory options.

### What's in the box:

- NINJA V
- 1 x Master Caddy II + screws
- International DC power supply
- Battery Eliminator
- NINJA V Quick Start Guide





# NINJA V Connections

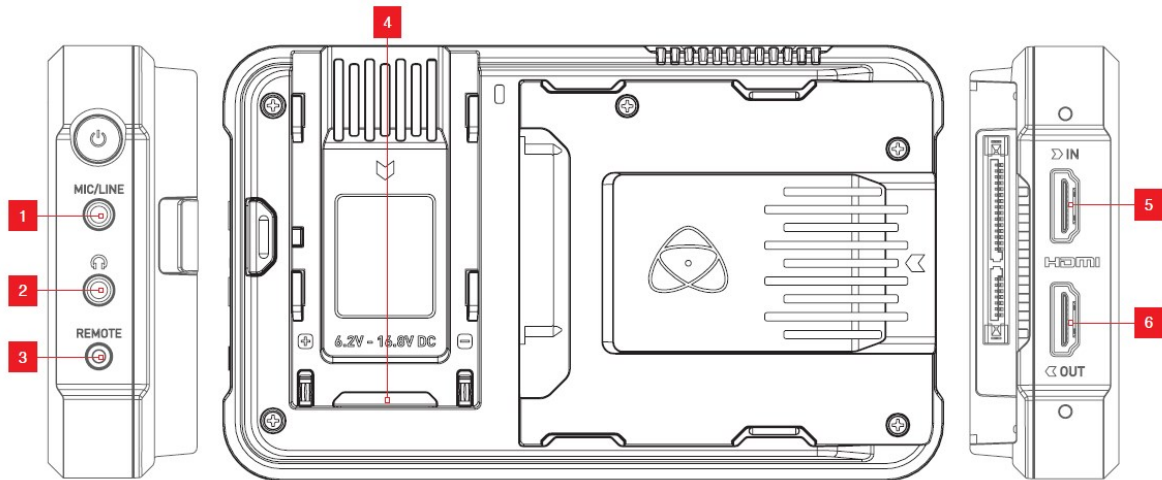

## Mic/Line in (1)

A 3.5mm input jack is located under the power button. Channel selection and volume for headphone monitoring is via the audio controls section, accessible by touching the audio meters in the top right side of the screen (monitoring mode) or in the bottom right of the screen (homescreen mode).

## Headphone/audio out (2)

A 3.5mm headphone jack is located above the remote port. Channel selection and volume for headphone monitoring is via the audio menu page on your NINJA V. To access this menu, tap the audio meters in the upper right side of the touchscreen (monitoring mode) or in the bottom right of the screen (homescreen mode). For more details refer to the "Audio Menu" on page 213 section.



*When monitoring any channels please ensure that the headphone selection is set to the stereo pair you'd like to monitor.*

## Remote/Calibration Port (3)

The calibration 2.5mm jack on the right hand side (looking from the front), allows for the connection of the Calibrite ColorChecker Display Pro / Display Plus calibration device. The calibration unit utilizes the optional [USB to serial adapter cable](#). The latest version of the ATOMOS Calibration software is available at [www.atomos.com/support](http://www.atomos.com/support)



*For optimal calibration it is recommended that your NINJA V is powered for 30 minutes prior to calibration.*

For remote operations via this port, ATOMOS supports both LANC in Sony and Canon format. The NINJA V uses LANC Client so a LANC controller must first be attached to a camera and the output taken out via a Y cable to the NINJA V.

## **AtomXpansion Port (4)**

Enhance your NINJA V through the built-in modular AtomXpansion port. Bi-directional high speed video, audio and power are available. Expansion modules dock into the battery slot and can be stacked, passing power and offer advanced connections and functions. [www.atomos.com/accessories](http://www.atomos.com/accessories)

## **HDMI in (5)**

The video input is a full size HDMI 2.0a connection used to receive the video. This connection also supports embedded audio and timecode if your camera or device sends these out over HDMI. The image is both displayed and recorded to the ATOMOS monitor/recorder storage media.

### **Embedded Audio**

Most mirrorless cameras and camcorders send 2 channels of audio over HDMI but the NINJA V can record up to 8 channels of digital audio embedded in the HDMI signal if supported.

## **HDMI Out (6)**

This is for connection to an external monitor or other device with an HDMI input. It carries a loop-through of the incoming HDMI signal in record and standby mode, and the playback signal when the NINJA V is in playback mode. This output is 2.0a and can carry either a 4K or HD signal (with the option to down convert the 4K input to HD).

### **Video Scale Convert**

Video out also has the option for a downscale to be applied allowing your 4K input to be converted to a 1080 HD output for use with existing HD equipment. DCI signals with a 17:9 aspect ratio have the option to be cropped to 16:9 to support a wider range of output displays.

### **3D LUT Output**

3D LUTs can be applied to the outputs of the NINJA V and LUTs can also be selected to be applied to the outputs and routed out to other equipment via the HDMI connections.

### **HDR Output**

The NINJA V can read the incoming HDR information frame from compatible cameras that indicates if a signal is HLG or PQ. You can set the NINJA V to automatically detect this and loop this out. You can also convert between a Log input to HDR display standards or between HLG <> PQ, and Dolby. For more information refer to Understanding HDR and Log in the Monitoring and Recording section.

## Best Practice

Understanding the basic controls and 'housekeeping' functions will save you time in the future. Before you start enjoying your NINJA V it will help to set the date and time, the 'device name' and file naming conventions.

### Date & Time

It is vital you set the correct date and time on your NINJA V to ensure that the metadata for your files is correct. To access the Date tab, tap the input indicator from the home screen Information bar.

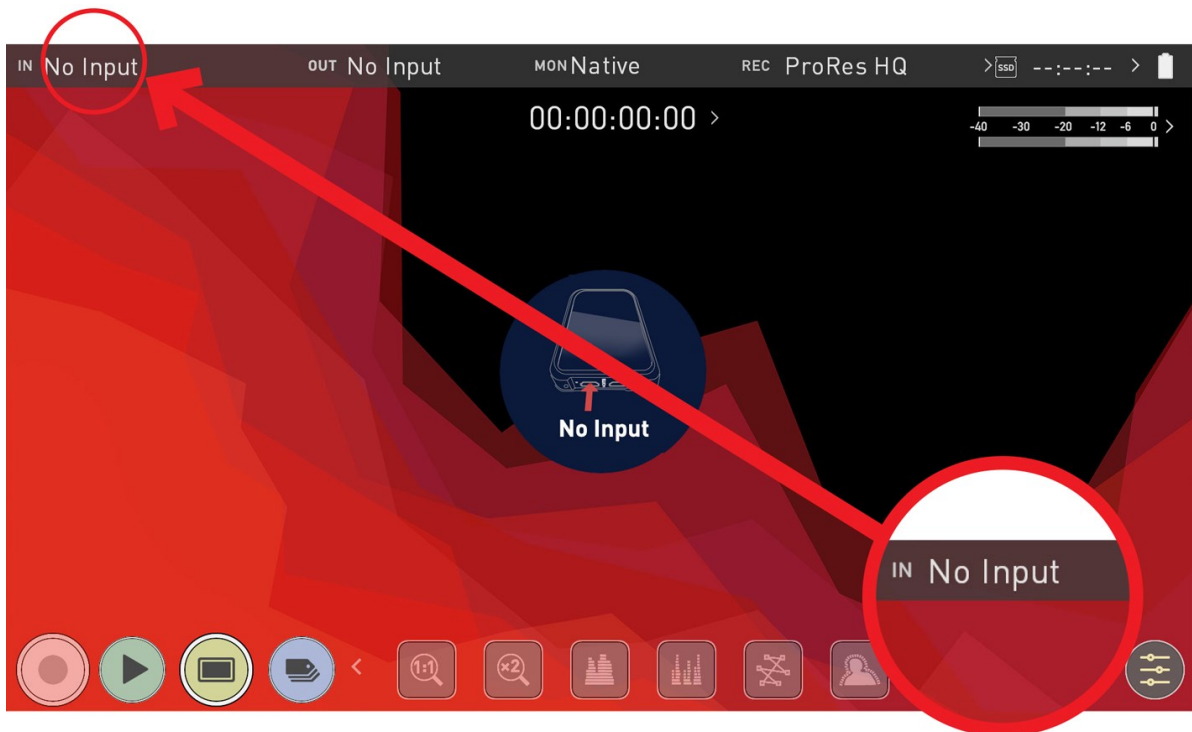

Then swipe the menu tabs to the left to navigate to the Date tab.



Swipe left to reveal more tabs that contain settings. If you cannot find the menu you are looking for, swipe left or right.

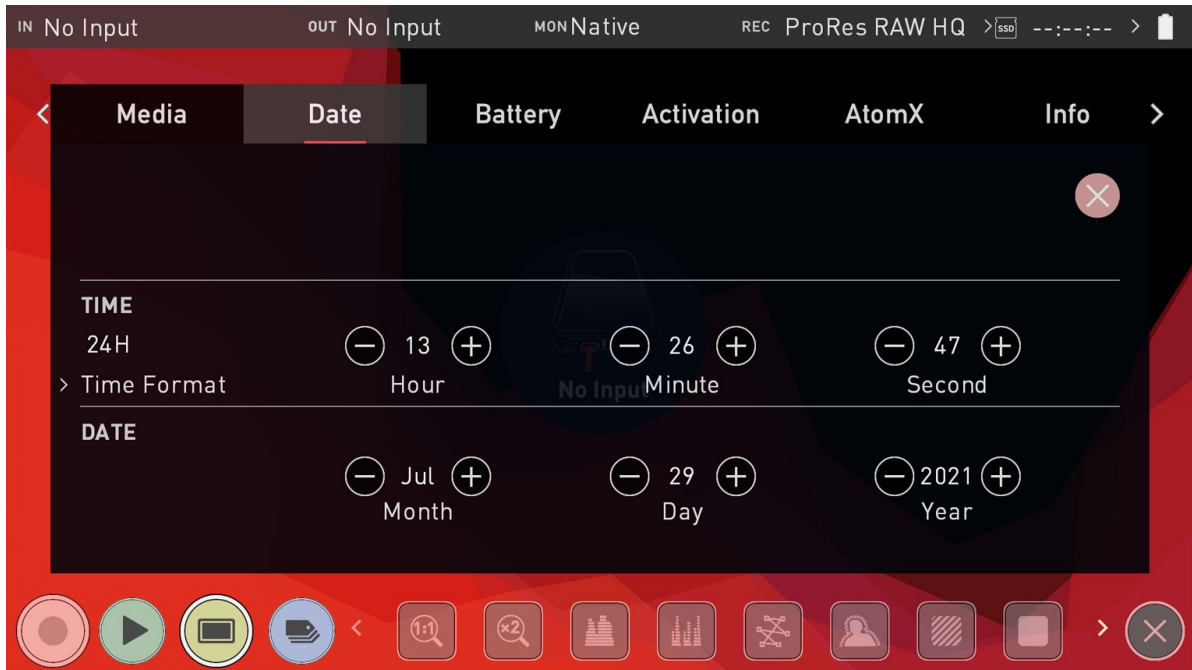

Use the -+ icons for each setting to set the time and date used on the NINJA V. For more information refer to the Date page in the Using the NINJA V section.

## Format Media

Make sure your drive is correctly inserted and all data from previous shoots has been securely backed-up. Touching the Storage Capacity Indicator on the home screen will take you to the Media Menu.

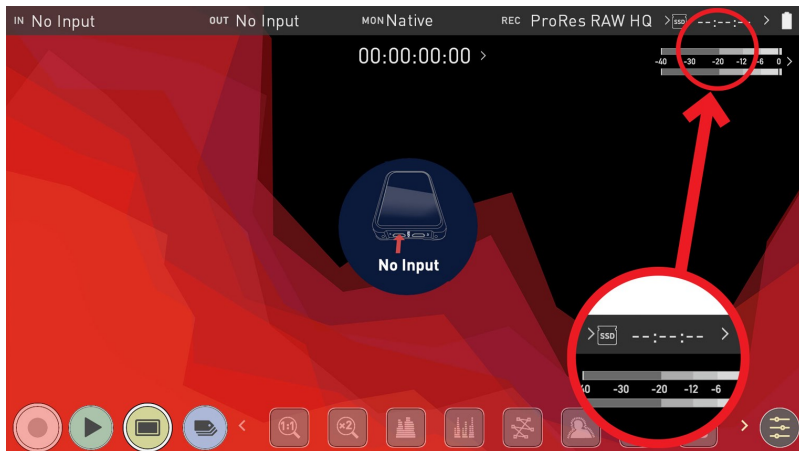

The Media menu provides information on the drive currently inserted. To format the drive tap the Format button (below).

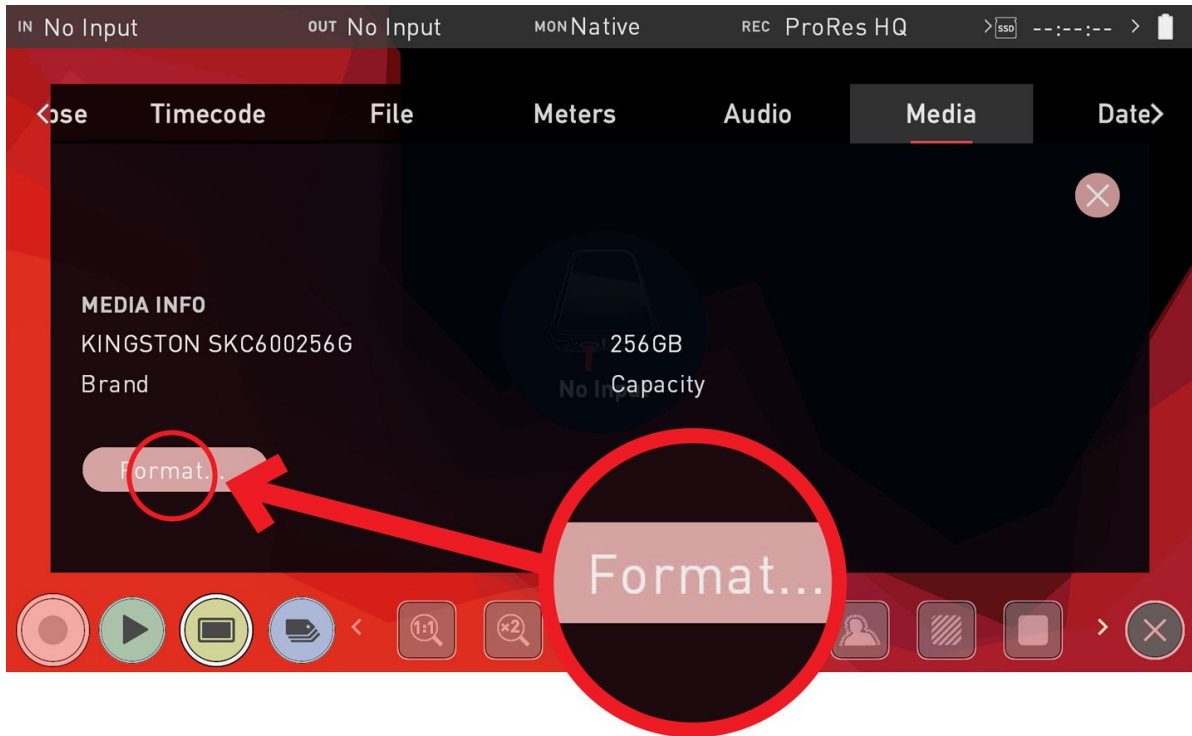

*When you first insert a drive you may be presented with 'Invalid media'. This means that the drive has not yet been formatted and you simply need to format your drive before using it.*



*If you do not see your hard drive information, there may be a problem with the connection or drive. Try removing the drive and reattaching the drive. Ensure correct alignment of your media.*



*The NINJA V uses the exFAT file system for broadest compatibility.*

## Secure Erase Format

For drives that carry the ATOMOS Logo such as the G-Technology 4K SSD, Angelbird 4KRAW, AtomX SSDmini by Angelbird and Sony, an option for Secure Erase is also presented. For more information refer to Secure Erase Format in "Media Menu" on page 218

## Unit Name

You can also modify the unit name for your NINJA V. Creating a unique name for each NINJA V you are using can be very useful when using multiple devices or with multicam shoots. Practicing good file management during production will save you valuable time in post production.

The unit name serves two main purposes:

- **Drive Naming:** Giving the unit a unique name aids with identification. Once you have given it a name all drives subsequently formatted in the NINJA V will bear this name as a prefix.
- **File Naming:** The current unit name appears at the start of the recorded clip name: NINJAV\_S001\_S001\_T001

To access the unit name, tap the input indicator from the home screen Information bar.

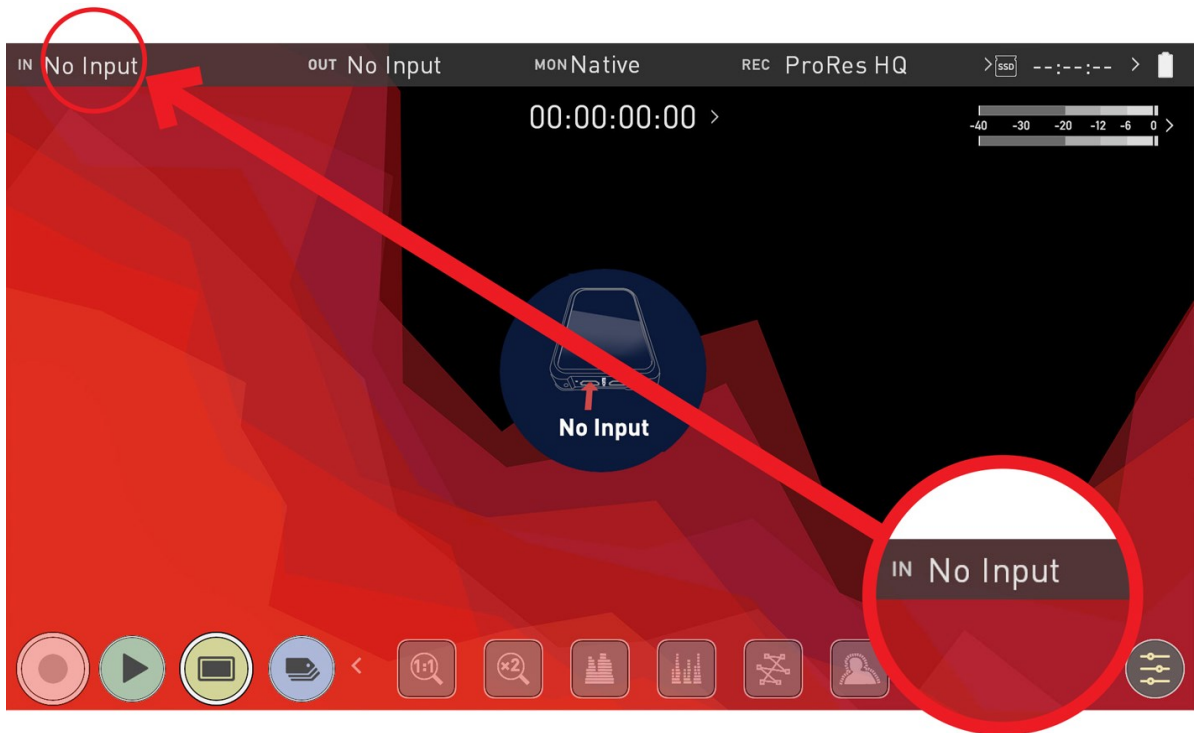

Then navigate to the **FILE TAB** where you can change the unit name.

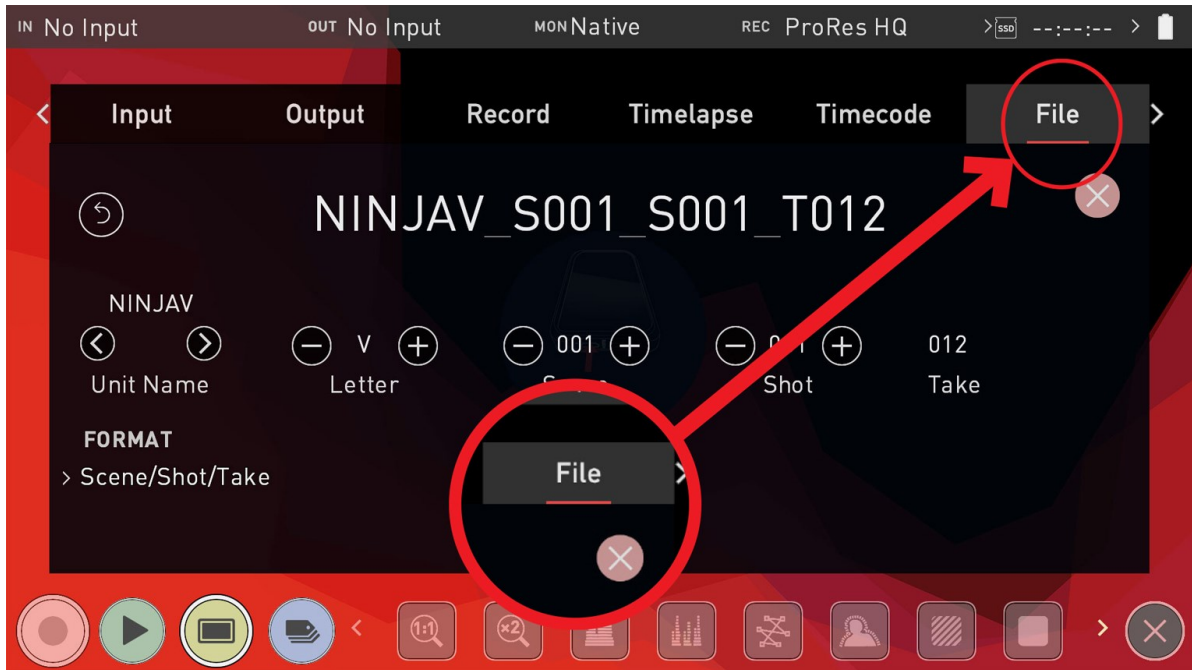

### How to change the Unit Name:

- Using the < > icons at Unit Name, select the letter to update. The character you are updating will display in the Letter indicator.
- Tap the Letter - + icons to change the character. When the correct letter is displayed, use the select control to move to the next character.





## File Naming

The File menu also allows you to adjust the Scene and Shot number that will form part of the recorded clip filename: NINJAV\_S001\_S001\_T001

### How to modify the File Name:

- Use the - + icons at Scene and Shot, to increase or decrease the numerical values.
- Once you have finished making changes, tap on Apply.

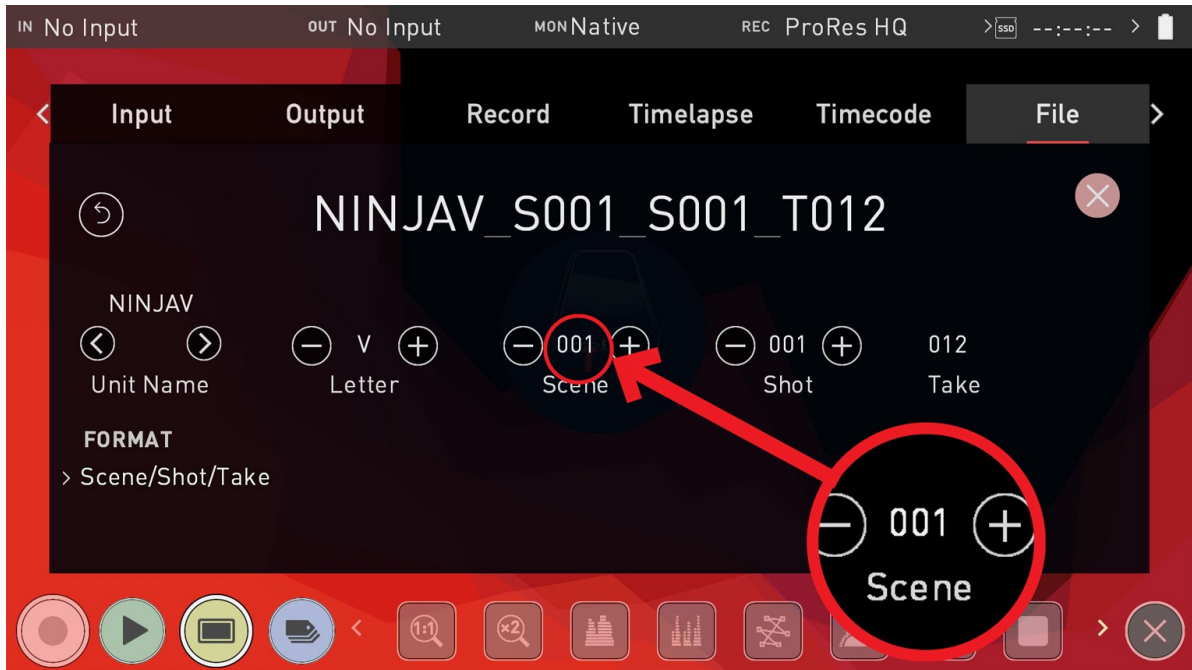

*When changing the drive please ensure that you take note of the last scene and take number so you can append this, as formatting a drive will reset the scene and take counter to 001,001,001.*

## Screen Lock

### Lock the Display Screen

You can lock the display of the NINJA V by tapping the power button. This will ensure no changes can be made by mistakenly touching the screen. Tap the power button again to unlock the unit.

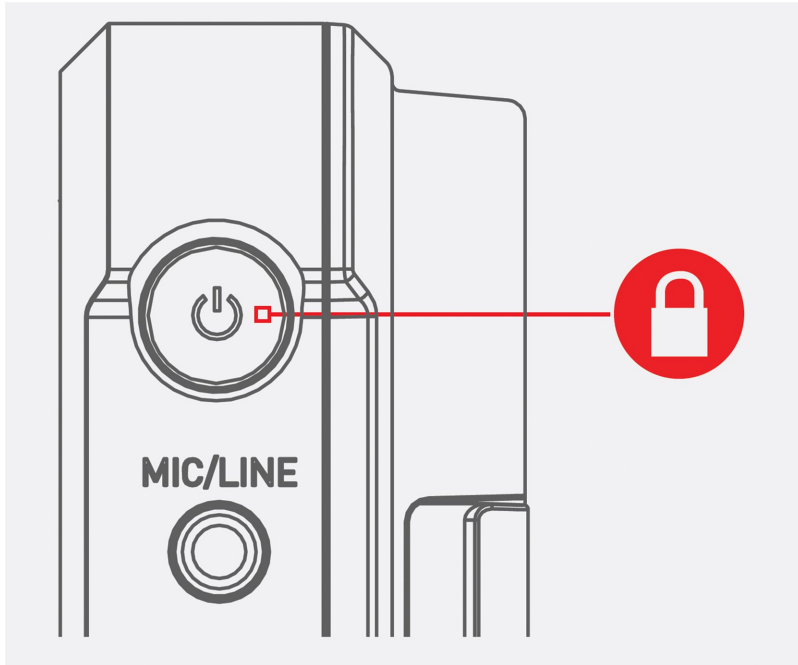

Images on screen will indicate whether tapping the power button has locked or unlocked the screen.

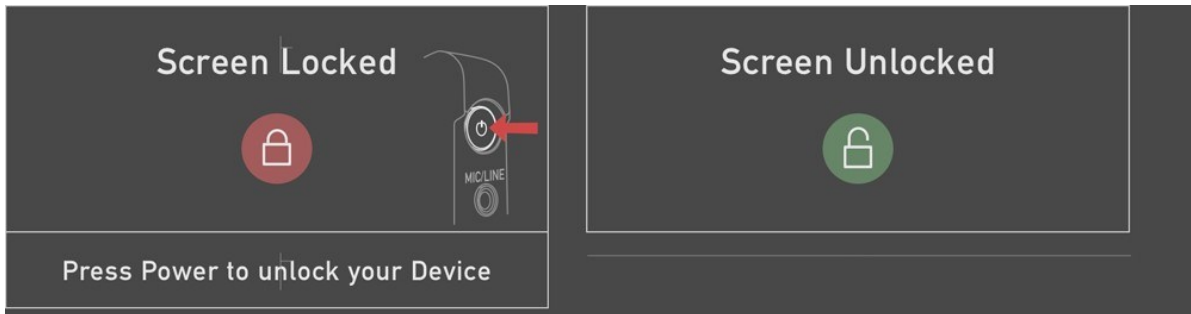

*The lock screen can be combined with the Display Off function so that when the screen is locked, the display is turned off. The Tally light on the front of the unit will still display Rec (Red) or idle (green) status. The Display Off function can be found in the Monitor menu. For more information refer to 'Display Off' in the "Monitor tab" on page 327 section.*

## AtomOS Updates (Firmware)

From time to time we will issue AtomOS (firmware) updates for your NINJA V. This is the software that runs inside your NINJA V and is available from our [support page](#), along with the release notes for each AtomOS release.

### How to update AtomOS (Firmware)

1. Tap the battery icon at the top right of the home screen on your NINJA V to open the Power menu screen, then select the Info tab. The Info menu page lists the AtomOS version and other important information about your NINJA V. Take note of the AtomOS version that is installed. In the image below the AtomOS version is 10.67.

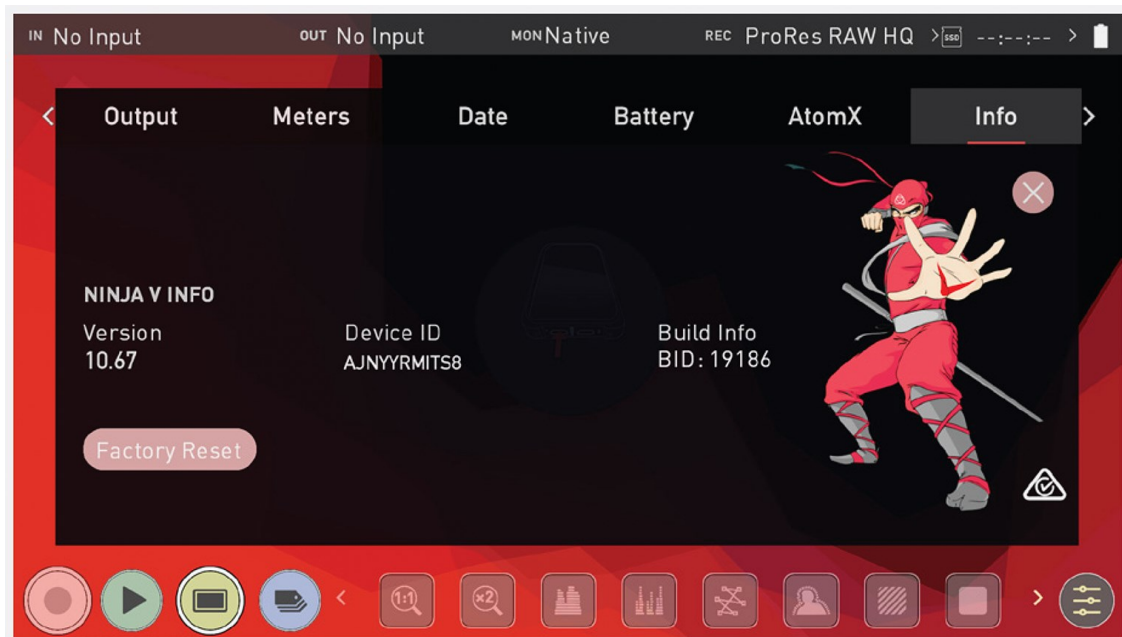

2. Visit [atomos.com/product-support](https://atomos.com/product-support) and check the current AtomOS version for NINJA V which will be listed at the top of the page. In the image below AtomOS 10.72.1 is greater than the AtomOS version number displayed on the NINJA V in the image above, so a firmware update is required. Click Download Firmware Update to download the update.



*The firmware release notes will list the date of release for each firmware version.*

The screenshot shows the top navigation bar with links for All products, On Camera, Live/Switching, On Set/In Studio, Accessories, Academy, Resellers, and Community. A search icon and a 'SHOP PRODUCTS' button are also present. On the left, a sidebar lists product categories: NINJA V, NINJA V+, NINJA CAST, NINJA V PRO KIT, NINJA V+ PRO KIT, NINJA STREAM (ARCHIVE), NINJA INFERNO (ARCHIVE), and NINJA FLAME (ARCHIVE). The main content area is titled 'Ninja V' and includes a sub-header 'Update to take advantage of the latest features for the best possible experience.' Below this, a 'Current Firmware' section highlights 'AtomOS 10.72.1' with a sub-header 'Updating to AtomOS 10.72.1'. It lists features, including 'Sony FX6 HDMI RAW Support', and provides two download buttons: 'DOWNLOAD FIRMWARE UPDATE' and 'DOWNLOAD RELEASE NOTES'.

3. Insert a [compatible](#), formatted drive into your Docking Station and connect it to your computer.



*Always format your drives in the NINJA V first. It formats the drive for optimal performance for video*

4. Unzip the downloaded zip file and copy the ATOMNJV.FW file to the root of the drive in the docking station.



*Ensure that the firmware update file is on the root of the drive, and not in a folder on the drive.*



*Make sure that the firmware file is not renamed when your computer unpacks the ZIP file. If you have other firmware in the same folder, the file may become renamed to ATOMNJV-1.FW when unzipping and the update will not work.*

5. Eject the drive (according to operating system guidelines).
6. Insert the drive with the ATOMNJV.FW file into the NINJA V. Use a freshly charged battery or connect to mains power. It is very important that your NINJA V does not lose power during a firmware update.



*ATOMOS strongly recommends that your NINJA V is plugged into mains power before commencing the firmware update. If using batteries for power, ensure that they have plenty of charge and that you do not interrupt your NINJA V while its firmware is upgrading. You will see a progress bar to the lower half of the screen. When it is finished, the NINJA V will restart and you will be able to use the device as normal. This process can take up to 5 minutes.*

7. Press the Power Button to power the NINJA V on. The AtomOS update process will begin automatically.



*If you place the .FW file on the drive and insert it into the NINJA V whilst it is turned on, the device will recognize the firmware update and ask if you'd like to apply the update. If you select 'OK' the device will shut down and begin the update process. Once the update has completed, your NINJA V will delete the .FW file and power down.*

8. If your NINJA V is already powered on, you will be prompted to perform the AtomOS update when a drive containing a new AtomOS version is inserted.
9. The ATOMOS logo will appear. After a few seconds the AtomOS update will start.
10. During the AtomOS update, an 'updating firmware' screen will appear. The update will take a few minutes.

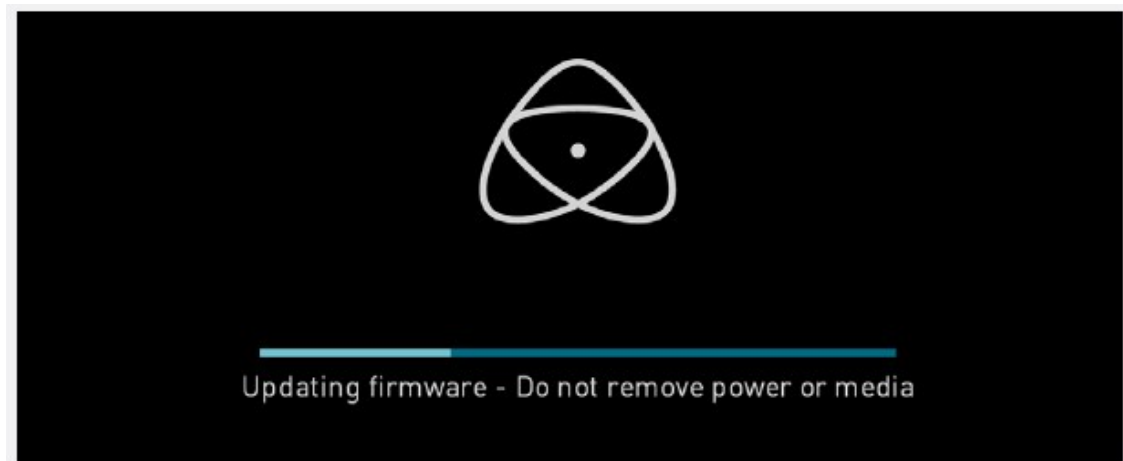

11. When the AtomOS update is finished, the NINJA V will:

- a. Delete the ATOMNJV.FW file from your drive.
  - b. Power itself down.
12. Power your NINJA V on and check that the AtomOS version is the version expected (menu>info tab).

For further information and troubleshooting on updating AtomOS, click [here](#).

***IMPORTANT: Problems when installing AtomOS***



*Very rarely, the firmware update process can go wrong. This might be because of an incomplete or corrupted download. In the unlikely event of your NINJA V becoming unresponsive, there is a built-in recovery mechanism. All you have to do is press and hold the on/off button for 10 seconds. If you do this your NINJA V will revert to its factory condition, and you will be able to retry the firmware update later (taking due precautions to identify and remove possible reasons for the failure of the previous attempt)*

## HDMI cables

ATOMOS makes a range of professional HDMI cables which are ideal for connecting between your camera and NINJA V. For 4Kp50/60p and RAW recording we advise the use of ATOMOS HDMI 2.0 cables. For more information and to purchase ATOMOS HDMI cables, visit the [HDMI Cables](#) page on the ATOMOS website.

In terms of third party HDMI cables, they are not all created equal and there are a variety of different qualities available. Please make sure you test your cables prior to shooting. This is particularly important when recording 4Kp50/60 and RAW. Many cables will claim to be high speed but will lack the required shielding on both cable and connector to maintain a high quality signal. If the signal contains errors that affect your recording, your NINJA V may not lock to these inputs.

Take care to use HDMI cables of the appropriate grade and ensure that you protect them from damage. Signal issues can often result from damaged HDMI cables, or from using cables that are too long.



*Also check your connectivity at both the camera connector and the recorder / monitor connector to make sure you have a firm connection, to avoid signal drop outs.*



*If the HDMI cable is removed whilst you are recording, the 'Skippy' icon will be displayed. Tap the Skippy icon and it will disappear, ready for the next notification.*



# Media

## Which drives should you use?

There are quite a large number of drives available on the market, and newer models appear all the time. To avoid potential data loss and/or write/read errors, ATOMOS only recommends the use of AtomX SSDmini, approved SSD media and CFAST II media only. For the most up-to-date information on compatible drives, please visit: [www.atom-os.com/drives](http://www.atom-os.com/drives)



*Spinning Disk Drives (HDD's) are not recommended for use with your NINJA V. They are not suitable for 4K recording or for use in environments or situations where they are subject to harsh vibration or mechanical shocks. They are also not suitable for external recording beyond 1080p30.*



*Master Caddy II does NOT fit into the NINJA V media slot when ATOMOS CONNECT is attached. Only Master Caddy III, AtomX SSDmini or AtomX CFast Adapter should be used in this scenario.*

## Solid State Drives (SSDs)

Widely available 2.5" SSDs are the basic storage media for ATOMOS Monitor Recorders. We work closely with leading drive manufacturers to qualify as many options as possible. Before using these drives, they need to be mounted in the Master Caddy II or Master Caddy III. For more information refer to "Mounting disks in the Master Caddy II " on page 47.

To purchase Master Caddy II units, visit [atomos.com/accessories/master-caddy-ii-5pack](http://atomos.com/accessories/master-caddy-ii-5pack)



## AtomX SSDmini

ATOMOS has teamed with the world's leading media manufacturers to design SSD media that is better suited to our ever evolving Monitor Recorders. The AtomX SSDmini is a little over 1/4 inch tall and 3" long. It is also 20% shorter than traditional SSDs, yet keeps the standard SATA III connector.

It fits directly into the NINJA V without the need for a Master Caddy II and is compatible with all ATOMOS recorders and docking stations. AtomX SSDmini is backward compatible with previous ATOMOS devices by adding a clever extension handle (SSDmini adapter). These tiny, slimline SSDs are a true innovation by our close drive partners Nextorage and Angelbird. 1 TB AtomX SSDmini by Angelbird pictured.

To purchase an AtomX SSDmini, visit the [Nextorage SSDmini](#) or [Angelbird SSDmini](#) pages on the ATOMOS website.

To purchase an SSDmini handle adapter, visit [atomos.com/accessories/ssdmini-handle](https://atomos.com/accessories/ssdmini-handle)



## AtomX CFast Adapter

The AtomX CFast adapter from Angelbird, utilizes the AtomX SSDmini form factor and allows you to use CFast 2.0 Type I cards for recording on ATOMOS NINJA V. When combined with the Angelbird AV PRO CF – CFast 2.0 memory card, you can capture RAW in high resolution and high frame rates. You can even utilize older CFast type 1 cards to upload and store 3D LUTs.

To purchase an AtomX CFast Adapter, visit [atomos.com/accessories/atomx-cfast-adapter](https://atomos.com/accessories/atomx-cfast-adapter)



## Secure Erase

For drives that carry the ATOMOS Logo such as the G-Technology 4K SSD, Angelbird 4KRAW, AtomX SSDmini by Angelbird and Sony, an option for Secure Erase is presented. This allows for the entire drive including the drive cache to be formatted. This will erase ALL content on the drive meaning nothing can be recovered. It will wipe all data off the drive (which may also be useful as a additional security measure) and reset it back as close as possible to factory conditions. The benefit of this feature is that it helps to maintain maximum drive performance, and therefore should be used when available.

## Backing up and archiving

Remember that no storage media, including tape, optical disks, spinning disks and flash memory, is completely immune from failure. You should bear this in mind when deciding how to manage your recorded content. At the very least, you should consider the consequences for you and your business if your storage media were to suffer from a sudden failure, and you should back up your content accordingly.

## Deleting files

To ensure the integrity of data writes and to avoid situations such as fragmentation, the ATOMOS operating system on the NINJA V does not support the deletion of files. We also do not advise removing or deleting files randomly from the disk on your computer. Often files are left in the trash or garbage partition of the drive occupying drive cache and this can affect drive performance. It's advised that you archive your content and reformat the drive before each shoot. For more details refer to the Using the NINJA V - Best Practice section.

# Master Caddy Docking Station

The Master Caddy Docking Station allows you to connect your media to your computer for editing directly from the drive or to copy the files to your own storage system. There are two ATOMOS Powered Docking Station models, the ATOMOS Powered Docking Station with USB 3.1 Gen 1 & 2.0 and the ATOMOS USB-C 3.1 Powered Docking Station. Both models support a single drive caddy at a time and efficiently offload the drive contents direct to your computer via integrated USB cables.

## ATOMOS Powered Docking Station models:

- **ATOMOS Powered Docking Station with USB 3.1 Gen 1 & 2.0.**

The integrated USB cable features one USB 3.0 and one USB 2.0 connector, with the latter provided for compatibility with older computers. Also provides support for an ATOMOS RAID Caddy power cable for connecting a RAID caddy.

To purchase the ATOMOS Powered Docking Station with USB 3.1 Gen 1 & 2.0, visit the [Docking Station](#) page on the ATOMOS website.



*The Master Caddy Docking Station is a sophisticated device supporting two different data interfaces: USB 2 and USB 3. When using the Master Caddy Docking Station you may need to connect both USB connectors. This is because when it has to power a disk drive and its interface electronics, the Docking Station may consume more power than is available from a single USB port.*



*When connecting the Powered Docking Station with USB 3.1 Gen 1 & 2.0 to a computer, a USB Type-C to USB Type-A Adapter may be required.*



- **ATOMOS USB-C 3.1 Powered Docking Station**

The integrated USB cable features one USB-C 3.1 connector for use with computers with a USB-C connection.



*When connecting the AtomX USB-C 3.1 Docking Station II with older computers a USB 3.0 Male to Type C Female adapter is required*



**All NINJA V media can be connected to a docking station:**

- AtomX SSDmini,
- Master Caddy II with SSD media installed,
- AtomX CFast adapter with CFAST II media inserted.

For the most up-to-date information on compatible drives, please visit: [www.atom-os.com/drives](http://www.atom-os.com/drives)



*Master Caddy 1 drives can connect to a Master Caddy Docking Station, but are NOT compatible with the NINJA V due to the compact latch design.*

## Standard 1/4" or 3/8" Mount/Arm

Below are some examples of tripod and hot shoe mounts, available from most camera and video specialists. A secure mount will greatly enhance usability and security of HDMI, power, remote and audio connections.



Your NINJA V has 3/8-16 connectors with 1/4-20 adapters and an ARRI style anti-rotational pin system on the top and bottom of the unit. Select the mount type that best suits your input device, application and conditions. For more information on the mounting points on the NINJA V refer to the "Mounting options" on the next page section.

## Mounting options

The NINJA V is designed for versatility, and includes multiple mounting options. The unit has 3/8"-16 screw mounts on the top and bottom, and comes with removable 1/4"-20 adapters installed in both locations. This allows you to have the option for a 3/8"-16 or 1/4"-20 screw mount on the top and bottom of your NINJA V.

The 1/4" adapter is easily removed for mounting on 3/8" fixtures. To remove it, use a flat head screwdriver to gently loosen the adapter and store your adapter in a safe location.

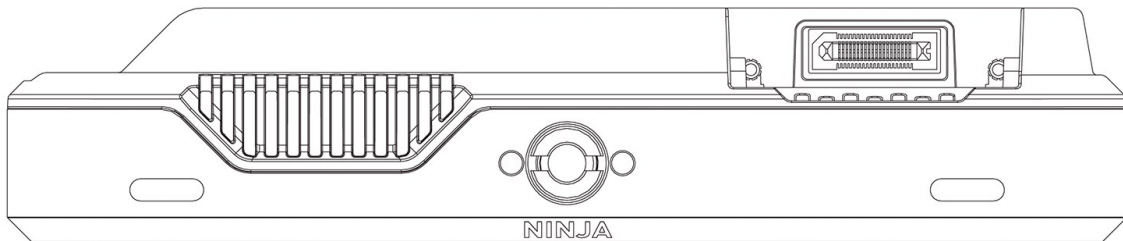

Top view

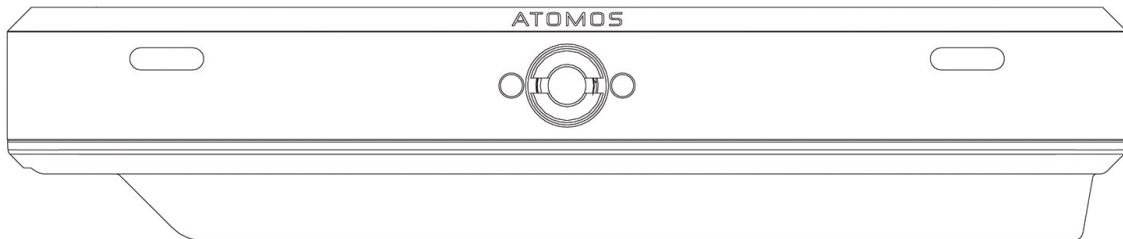

Bottom

The mounting points on the top and bottom of the unit feature ARRI style anti-rotational pins, which allows for secure mounting of your NINJA V to a wide range of arms, mounts, cages and gimbals. It is compatible with the latest mounting solutions from companies such as Shape, SmallRig and Wooden Camera.

For information and to purchase the ATOMOS AtomX 5" NINJA V Cage by SmallRig, visit the [5" NINJA V Cage](#) page on the ATOMOS website.



*Ensure you do not over tighten the screw mounts as this may cause damage. Do not insert a 1/4-20" or 3/8"-16 thread longer than 5mm or you will risk causing damage to the aluminum chassis.*

## Choosing your power source

The NINJA V can be powered by the included AC-powered Battery Eliminator, or by using a compatible DC battery. If you are the owner of other ATOMOS devices, the batteries you have for these devices (NP-F/L Series) will be compatible with your NINJA V.

### Battery Eliminator

Included in the NINJA V box is a Battery Eliminator. This connects directly to the battery slot of your NINJA V and allows you to connect the included power supply for an AC power connection. It is also compatible with the [ATOMOS coiled DC to D-Tap cable](#).

To purchase a Battery Eliminator, visit the [Battery Eliminator](#) page on the ATOMOS website.



*The Battery Eliminator is suitable for use with ATOMOS devices only.*



### Batteries

We recommend the use of optional ATOMOS NP-F type batteries and the ATOMOS Power Kit with the NINJA V. The NINJA V can also use standard NP-F/L-Series compatible batteries. Charge new batteries before using them, using a compatible battery charger. To attach the battery, gently slide it down into the slot until it locks into position. To remove a battery, push the latch to release it.

To purchase ATOMOS NP-F type batteries, visit the [5200mAh \(4 cell\)](#) or [7800mAh \(6 cell\)](#) pages on the ATOMOS website.





## Choosing the right battery for your application

Size	Cells	Battery Life*
5200mAh	4	Up to 2 hrs
7800mAh	6	Up to 3 hrs
Battery Eliminator	-	Continuous AC
D-Tap	-	Source dependent

\* Battery life tested during Monitor/Record 4Kp60 operation.



*Before any type of disposal the battery should be discharged completely. Tape the contacts with electrical tape and package so as to prevent contacts accidentally coming together at any time.*



*Incineration must be performed by an approved and permitted waste treatment facility that handles lithium ion batteries. If you are not sure if your waste facility can handle lithium ion batteries, contact them and verify if they are permitted or not.*

## ATOMOS Fast Battery Charger (optional)

The ATOMOS Fast Battery Charger has been designed to rapidly charge NP-F type batteries, yet be lightweight so that is easy to travel with. To purchase an ATOMOS Fast Battery Charger , visit [atomos.com/accessories/fast-battery-charger-power-supply](https://atomos.com/accessories/fast-battery-charger-power-supply)



*Fast charging of the battery is possible up to 80% capacity and the remaining 20% will then charge at a slower rate to maintain optimal battery life.*



*In the unlikely event of a charge error the first and last red LEDs will flash quickly.*

## Attaching a Battery or a Battery Eliminator

### Battery slot

Gently slide down into battery slot and lock into position

Push the release button to unlock the battery and slide battery upwards to remove.

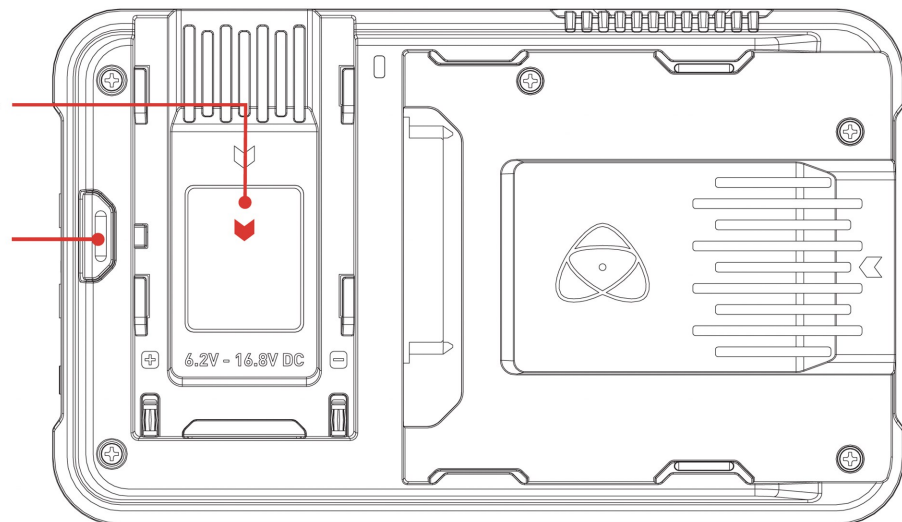

*Once locked into position, NINJA V batteries and modular accessories are held in place tightly to ensure that they cannot work loose. You may have to be quite firm with the battery latches to remove batteries and accessories,*



*so we suggest that you familiarize yourself with the force required so that you can do this quickly in the field.*

## **12V-3A AC power supply**

The included 12V-3A AC power supply connects to the Battery Eliminator to supply power to your NINJA V. When you have an AtomX CAST connected to your NINJA V, the power supply connects to the DC input on the AtomX CAST to provide power for both NINJA V and AtomX CAST.

## **DC to D-Tap Coiled Cable**

The DC to D-Tap Coiled Cable is an optional ATOMOS accessory. It is designed to allow you to power your device from an external battery system with a D-Tap port. Simply connect the D-Tap connector to your power source.

To purchase a DC to D-Tap Coiled Cable, visit [ATOMOS coiled DC to D-Tap cable](#).



*Ensure that the output of the power source does not exceed 16.8V DC.*



# Powering On and Off

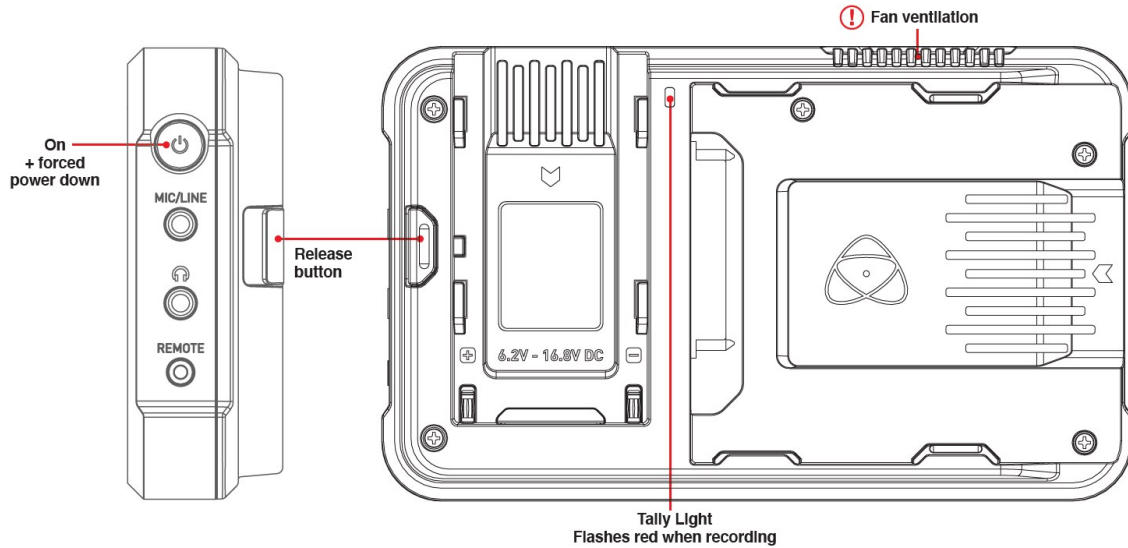

## Turning ON power to the NINJA V

The Power button is located on the top right hand side of the unit (as you look at the screen). With a power source connected, momentarily press the Power button. After a couple of seconds you will see the ATOMOS logo then the NINJA V Home Screen.

## Turning OFF power to the NINJA V

To turn the unit off, tap the battery icon on the top right of the home screen to open the Power menu screen.

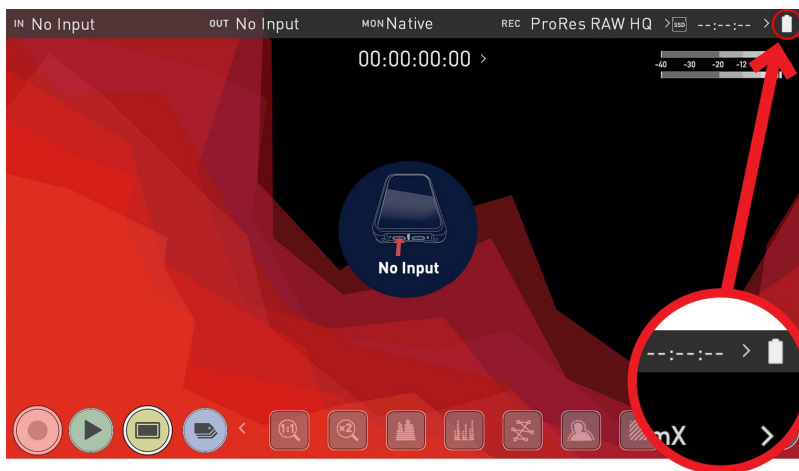

On the Power menu screen press the green Power icon for 4 seconds. **Four seconds** can seem like a long time, but this is intentional to make sure that the NINJA V can't be turned off accidentally.

The icon will turn red when touched to indicate activation of the button. The unit will then power off. You can also do a forced power down by pressing the physical Power button on the side of your NINJA V for four seconds.

For more information on the Power menu see the "Power Menu" on page 221 section.

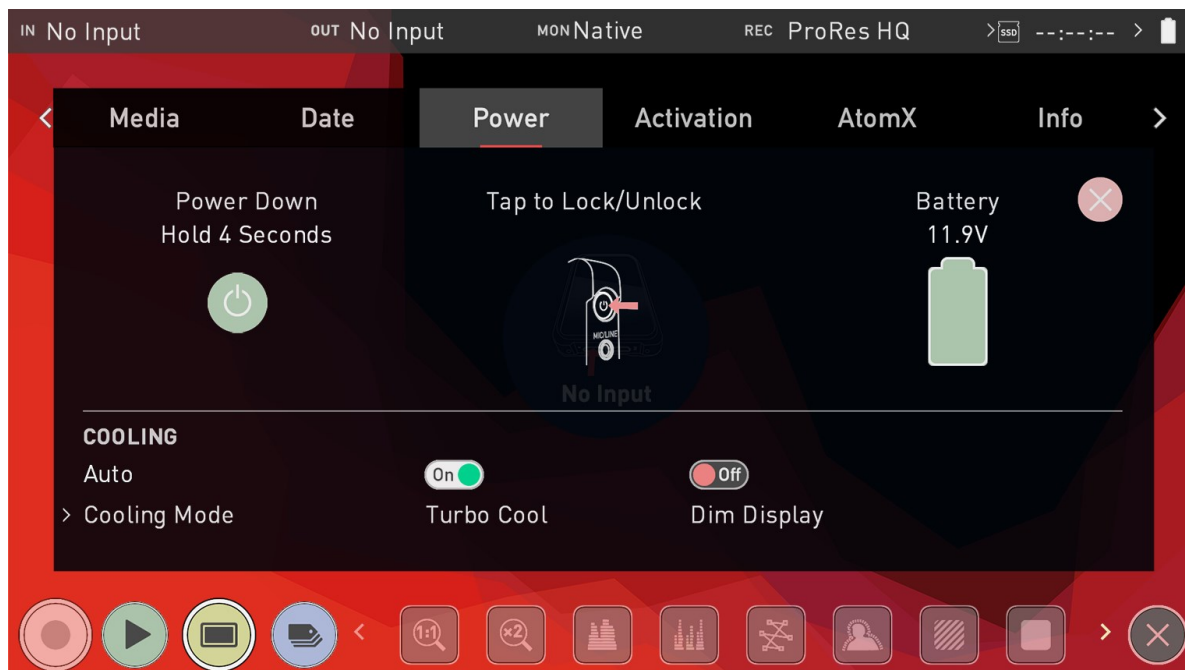

*Do not press and hold the power button in on the NINJA V while the unit is off. This will place the device in to a Firmware recovery mode. If you accidentally do this, simply turn the device off again or remove the power source.*



*Take note to respect the air flow and do not obstruct the cooling vents of the unit.*

# Inserting and Removing Media

## Inserting Media

On the rear of the unit is a 2.5" slot designed for your media. To insert an AtomX SSDmini, Master Disk Caddy II/III or the AtomX CFast adapter, gently push the media into the slot until it stops at the end of the drive slot.

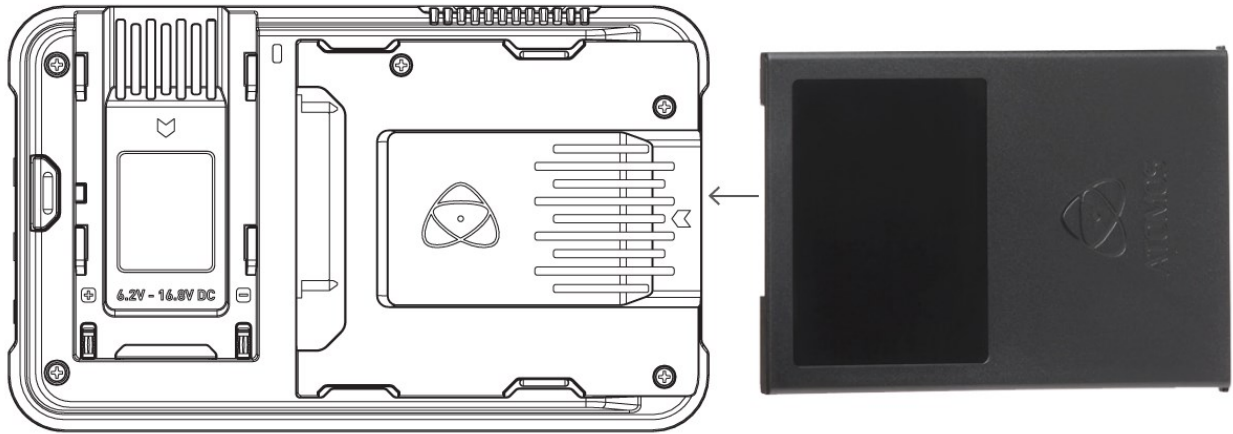

## Removing Media

The SSDmini, Master Caddy II/III and the AtomX CFast adapter are all hot-swappable, so you can remove the media at almost any time – even while the unit is turned on. But don't do it while recording or you will get a corrupted file that may be unplayable. To remove media, simply pull it out from the slot by holding the top and bottom tabs on the media itself.



*The NINJA V disk slot does NOT have a release latch for media. It is a friction-fit system. Simply pull the SSDmini / Master Caddy II out using the top and bottom tabs on the caddy itself.*



*The AtomX SSDmini Handle is available as an optional accessory, and can be attached to your AtomX SSDmini. This allows it to be used with existing ATOMOS Master Caddy II devices, and also reduces handling and potential damage to the disk casing.*



*AtomX SSDmini is backwards compatible with previous ATOMOS recorders.  
The original Master Caddy 1 is NOT compatible with NINJA V as the keyways  
are on one side only.*

## Mounting disks in the Master Caddy II

If you choose to use your own disks instead of using a pre-built AtomX SSDmini, then it needs to be installed into a Master Caddy. The Master Caddy is a plastic shell that holds your disk in place, and has two variants - Master Caddy II and Master Caddy III.

Master Caddy II is still supported on NINJA V, however, if you are using an ATOMOS CONNECT with your NINJA V, then you **must** mount your disks in a Master Caddy III to ensure that the disks can be inserted into the media slot when an ATOMOS CONNECT is attached to your NINJA V.

For more information on using Master Caddy III, refer to "Mounting Disks in Master Caddy III" on page 49



*Master Caddy II does NOT fit into the NINJA V media slot when ATOMOS CONNECT is attached. Only Master Caddy III, AtomX SSDmini or AtomX CFast Adapter should be used in this scenario.*

### How to mount a disk into Master Caddy II

Insert the disk into the caddy, and secure with the four supplied screws. These screws should be tightened so the screw heads are flush with the casing of the caddy. The caddy is light and the disk just needs to be held securely.

Don't over-tighten the screws. There are no connections to make because sliding the Master Caddy II into the NINJA V or the docking station makes all the connections for you.

The Master Caddy can't be inserted the wrong way round. Always make sure that the disk connector faces the slot in the NINJA V. Push the Master Caddy II into place, but never force the disk just in case something isn't set up or aligned properly. For information on attaching media to a Master Caddy Docking Station see "Connecting media" on page 361.

There is very little that can cause problems, but if there is an issue it is likely that the Master Caddy isn't properly flush with the drive inside. A quick visual check will confirm this.



*Spinning disks and SSDs are very sensitive to damage from static electricity. Please observe all the usual precautions when handling them and NEVER touch the exposed SATA connector as static electricity may be harmful to your disk.*





*Master Caddy II drives are backwards compatible with previous ATOMOS recorders, however Master Caddy 1 is not forward compatible with the NINJA V due to the compact latch design*

## How to Mount Disks in the Master Caddy II

**1** Carefully assemble the Master Caddy and disk

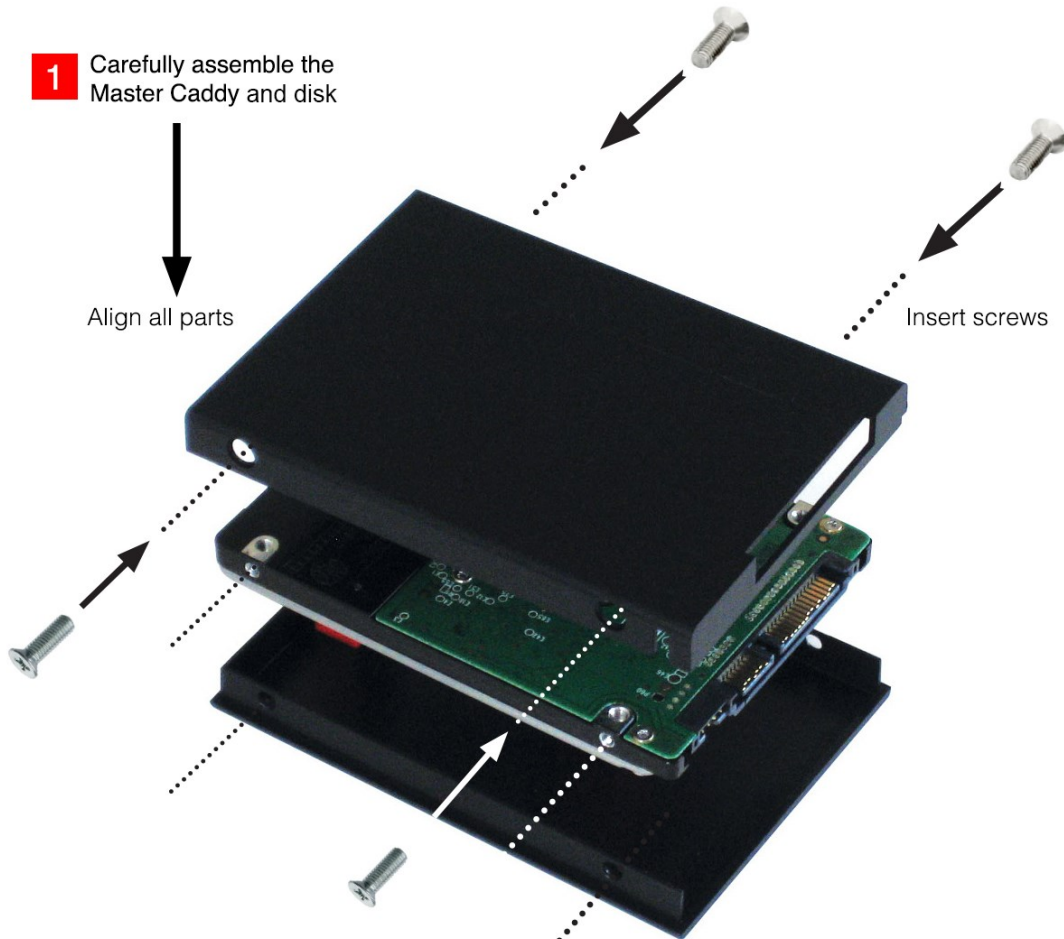

**2** Ensure all 3 parts aligned and insert 4 x screws (supplied)

Do not over-tighten screws or alignment can not be guaranteed. We suggest squeezing the corners together near the screw you are tightening for optimal fit.



Ensure all screws are tight and not protruding from casing. Loose screws may cause the caddy to become lodged in the disk slot.

## Mounting Disks in Master Caddy III

If you choose to use your own disks instead of using a pre-built AtomX SSDmini, then it needs to be installed into a Master Caddy - a plastic shell that holds your disk in place.

Master Caddy III was introduced with the release of the ATOMOS CONNECT accessory, and must be used when ATOMOS CONNECT is attached to the NINJA V. If you have used Master Caddy II before with other ATOMOS products, you will notice that Master Caddy III has a slimmer, lighter weight design to ensure that the disks can be inserted into the media slot when an ATOMOS CONNECT is attached to your NINJA V. A Master Caddy III and screws are provided in the box when you purchase an ATOMOS CONNECT.

For information on drives that are compatible with your NINJA V, refer to the compatible drive page at [atomos.com/compatible-drives](https://atomos.com/compatible-drives)



*Master Caddy II does NOT fit into the NINJA V media slot when ATOMOS CONNECT is attached. Only Master Caddy III, AtomX SSDmini or AtomX CFast Adapter should be used in this scenario.*

### How to mount a disk into Master Caddy III

When inserting the disk into the Master Caddy III, ensure that the SATA connectors of the drive line up with the gap in the plastic shell. If they do not line up with this gap, turn the drive over.

### Correct alignment



### Incorrect alignment

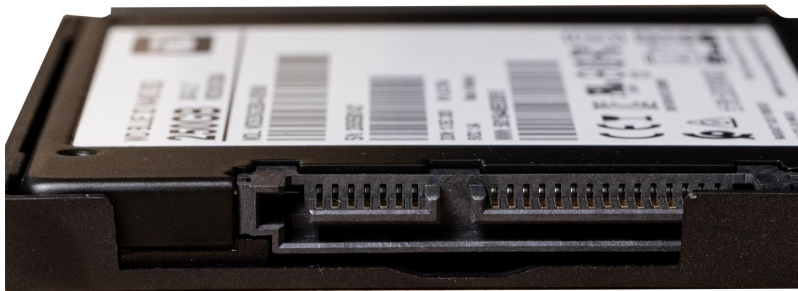

*It is important to properly align the drive correctly with this gap in the Master Caddy III, so that the drive can connect to the SATA connectors on NINJA V when inserted.*



*SSDs are very sensitive to damage from static electricity. Please observe all the usual precautions when handling them and NEVER touch the exposed SATA connector as static electricity may be harmful to your disk.*

With the drive inside the Master Caddy III, use the four supplied screws to secure the drive in place. These screws should be tightened so the screw heads are flush with the casing of the caddy. The caddy is light and the disk just needs to be held securely.



*Take care not to over-tighten the screws.*

When inserting the Master Caddy III into the media slot on your NINJA V, ensure that the SATA connectors on the disk line up with the SATA connectors on your device. Gently push the Master Caddy III into place, but never force the disk just in case something isn't set up or aligned properly.

If you experience difficulty when inserting the Master Caddy III to your device, the drive may not be sitting correctly in the Master Caddy or the screw heads may not be flush with the casing of the caddy. A quick visual check will confirm this. Remove the drive and re-insert it in the Master Caddy III.

For information on attaching media to a Master Caddy Docking Station see "Connecting media" on page 361



*Master Caddy II is still supported on NINJA V when an ATOMOS CONNECT is not attached to your NINJA V. For information on using Master Caddy II, refer to "Mounting disks in the Master Caddy II " on page 47*

# AtomX Expansion Modules

AtomX expansion modules attach to the AtomXpansion port on your NINJA V, and provide additional connections and functionality.

## AtomX SDI Expansion Module

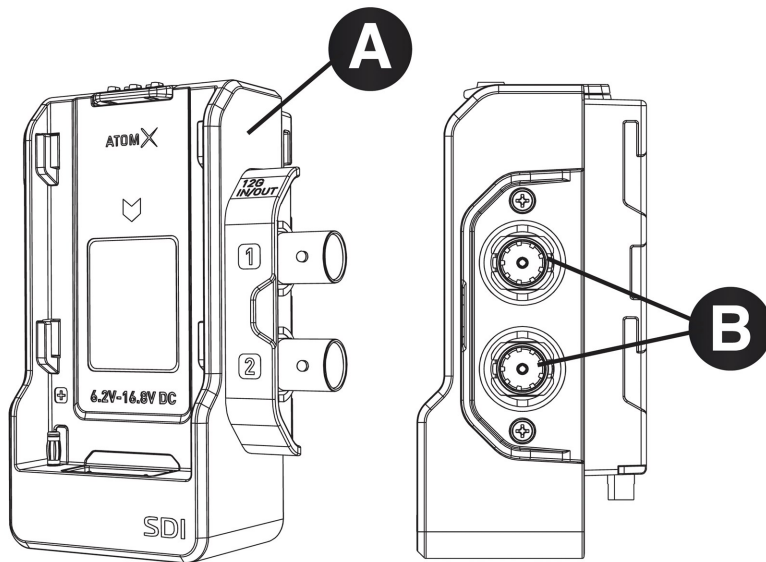

The AtomX SDI Expansion Module (A) adds the quality and convenience of SDI connectivity to your NINJA V, which allows you to monitor and record SDI video up to 4Kp60 from a range of professional cameras and video sources. The two BNC connectors (B) allow for input and output connections, so you can send video to or receive video from any SDI device. This provides flexibility for any video or film production to allow all crew including directors, cinematographers, assistants and focus pullers to monitor and replay identical and calibrated content in HDR at the same time.



*To use the AtomX SDI Module with your NINJA V, firmware version 10.1 or later needs to be installed.*

The AtomX SDI Expansion Module also allows you to cross convert signals between HDMI and SDI. This means that where HDMI sources are connected to your NINJA V, an SDI signal can be output from both of the BNC connectors on your AtomX SDI Expansion Module. Where an SDI video signal is connected to your AtomX SDI Expansion module, you can output an HDMI signal over the HDMI Out connector on your NINJA V. Cross conversion happens automatically, and does not need to be enabled. For more information on cross conversion refer to "Cross Conversion" on page 105.

For more information or to purchase an AtomX SDI Module, visit [atom-os.com/accessories/atomx-sdi](https://atom-os.com/accessories/atomx-sdi)



*To use the cross conversion feature, firmware version 10.6 or later needs to be installed on your NINJA V.*

## **SDI RAW**

You can add the SDI RAW feature to your NINJA V by purchasing the optional SDI RAW upgrade at [my.atomos.com](https://my.atomos.com)

After activating the feature on your NINJA V, you can use the AtomX SDI Expansion module to record RAW over SDI from compatible cameras. Refer to Activation section for more information on the activation process.



*To use the AtomX SDI Module for SDI RAW, firmware version 10.6 or later needs to be installed on your NINJA V.*



*When RAW over SDI is enabled on a connected camera, your NINJA V will automatically detect the RAW signal and prompt you to select ProRes RAW as the recording codec.*

## **AtomX SYNC Expansion Module**

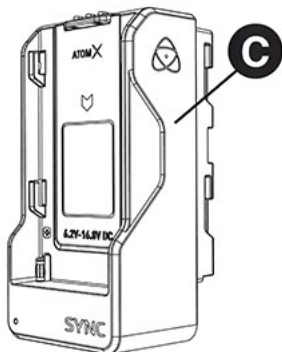

The AtomX SYNC Expansion Module (C) adds professional wireless timecode and sync to any HDMI camera or source, making it easy to integrate consumer cameras into multicam productions. This allows for perfect synchronization with a range of other products including iOS devices, professional audio recorders and cameras. The ATOMOS UltraSync ONE and UltraSync Blue can also be used to bring multiple cameras and devices into perfect sync.

The result is that your footage and audio from multiple sources will be perfectly aligned when you bring it into your NLE timeline. You can sync and/or control any number of NINJA V units equipped with AtomX Sync modules on the same network at ranges of 200m+. AtomX Sync also has a built-in battery extender that allows for continuous power when swapping batteries, ensuring uninterrupted operation of the NINJA V during a shoot.

For more information or to purchase an AtomX SYNC visit [atomos.com/accessories/atomx-sync](https://atomos.com/accessories/atomx-sync)



*To use the AtomX SYNC Module with your NINJA V, firmware version 10.4 or later needs to be installed.*

# AtomX CAST

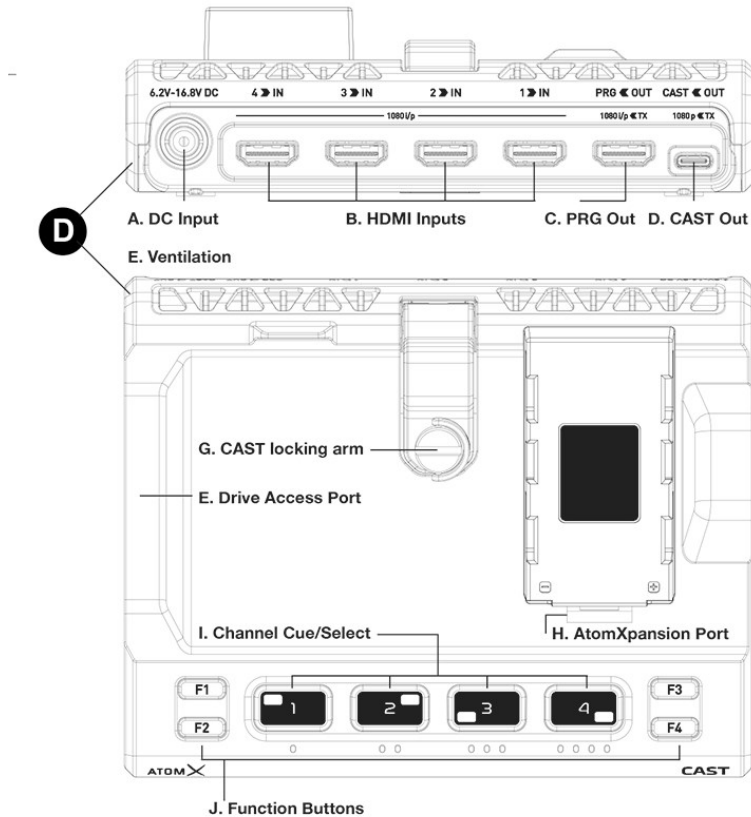

**K.** When docked into the AtomX CAST the HDMI input on the Ninja V/V+ is NOT IN USE.

**L.** HDMI OUT - The HDMI Output of the Ninja V/V+ can be configured for use as **Program, Preview or Multiview output**. This is configured from with the menu of the Ninja V/V+.

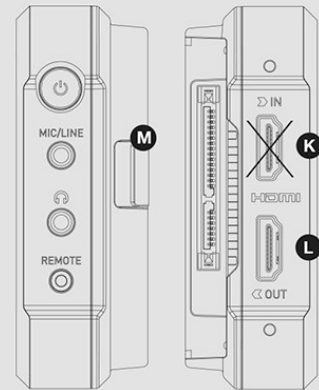

**M.** Release Button - press the battery release button on the rear right hand side of the Ninja V/V+ to disengage the AtomXpansion Port.

The AtomX CAST (D) is a modular companion that transforms the NINJA V into a 4 input HDMI switcher. The combination of the NINJA V and AtomX CAST becomes the Ninja CAST, a fully functional stand-alone switcher with an integrated high quality 5" HDR touch-screen monitor with multi-view, broadcast quality recording and physical buttons - that can be used anywhere and does not require a computer to function. The flexible control options allow you to use either the touchscreen or the physical buttons to 'switch' between sources when deciding what should be on screen at any one time for broadcast.

Ninja CAST appears as a high-quality webcam to your computer, and it works immediately with your video applications like Zoom, Teams and Skype without the need to install drivers on the computer. Create broadcast quality multicamera programs and use features like logos, graphics and picture in picture to enhance your online meetings, presentations, conferences, remote learning/training, virtual conferences or demonstrations.

To purchase an AtomX CAST visit [atomos.com/accessories/atomxcast](https://atomos.com/accessories/atomxcast)





*To use AtomX CAST with your NINJA V, firmware version 10.71 or later needs to be installed.*

# ATOMOS CONNECT

ATOMOS CONNECT attaches to the AtomXpansion port on your NINJA V and provides additional connections and functionality. It features a 12G-SDI input, ATOMOS AirGlu™ wireless sync timecode technology for direct, long-range communication between devices, multiple power options to accommodate a variety of on-set scenarios, plus Wi-Fi 6 and Gigabit Ethernet. When attached to the NINJA V, the ATOMOS CONNECT transforms professional cinema, mirrorless, and DSLR cameras into fully connected devices that support a range of advanced cloud-based workflows. For more information on cloud-based workflows refer to the "Connect Menu - Atomos Cloud Studio" on page 144 section.



To use the ATOMOS CONNECT with your NINJA V, ensure you have AtomOS firmware version 10.8 or later installed. Visit [atomos.com/support](https://atomos.com/support) to download firmware for your device.

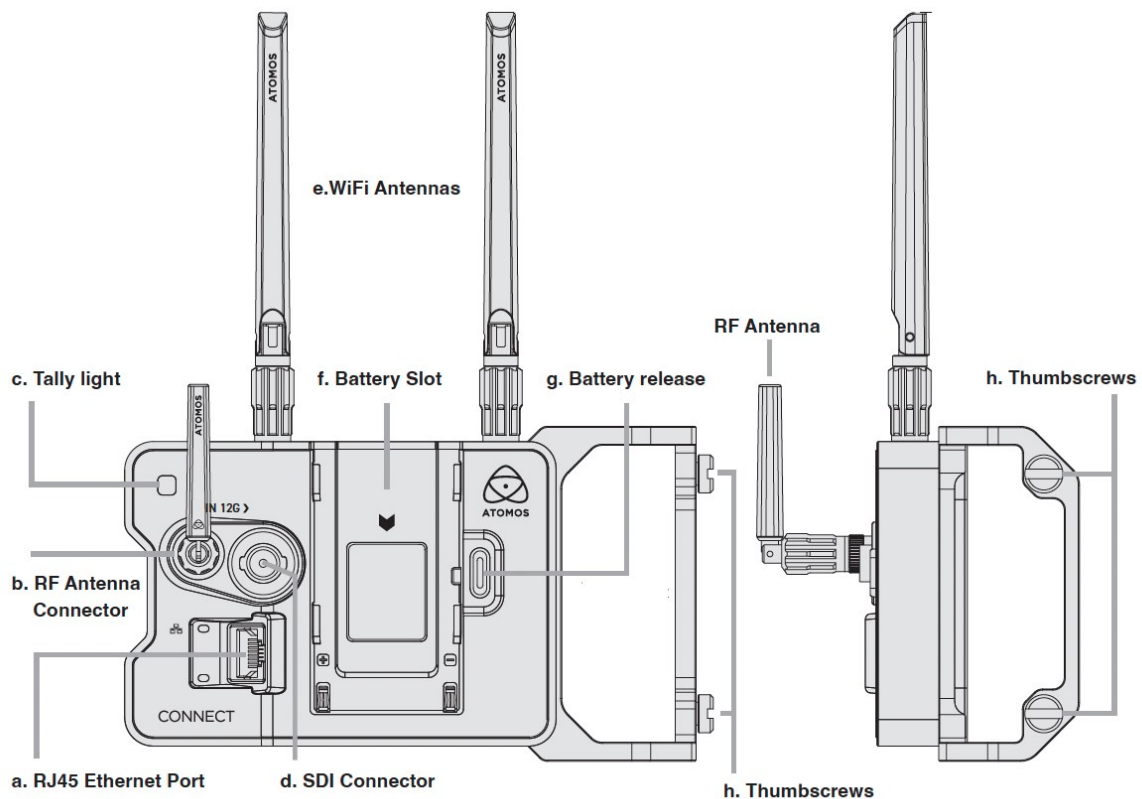

## ATOMOS CONNECT Connections

### a. RJ45 Ethernet Port

1Gbe Ethernet for a high-speed robust hardwired network connection.

### b. RF Antenna Connector

Connect the supplied RF antenna for AirGlu™ wireless SYNC functionality.

### c. Tally Light

Red Tally light on the rear of the unit will flash when recording. Tally light can be enabled/disabled in the "Monitor tab" on page 327.

### d. SDI Connector

The SDI input connector is 12G compliant and backwards compatible with 6G, 3G and 1.5G signals.

### e. WiFi Antennas

Connect the two supplied WiFi antennas in this position. Wi-Fi 6 provides high performance wireless connection and mobile hotspot support

### f. Battery Slot

Attach NP-F / L-Series batteries or a Battery Eliminator to supply power.



*You cannot attach or 'stack' AtomX modules to the Battery Slot (f) on the ATOMOS CONNECT accessory.*

## g. Battery Release

Press and slide an attached power source away from the unit to remove it.

## h. Thumb screws

Use the provided thumb screws to securely attach the CONNECT to the left side of your NINJA V.



*Take care not to over tighten the thumb screws.*



*Master Caddy II does NOT fit into the NINJA V media slot when ATOMOS CONNECT is attached. Only Master Caddy III, AtomX SSDmini or AtomX CFast Adapter should be used in this scenario.*

## Attaching / Removing ATOMOS CONNECT

The ATOMOS CONNECT attaches to your NINJA V in the same way that you attach AtomX modules to your NINJA V.

### To attach the ATOMOS CONNECT to your NINJA V:

1. Line up the rear part of the ATOMOS CONNECT with the AtomXpansion port of NINJA V.

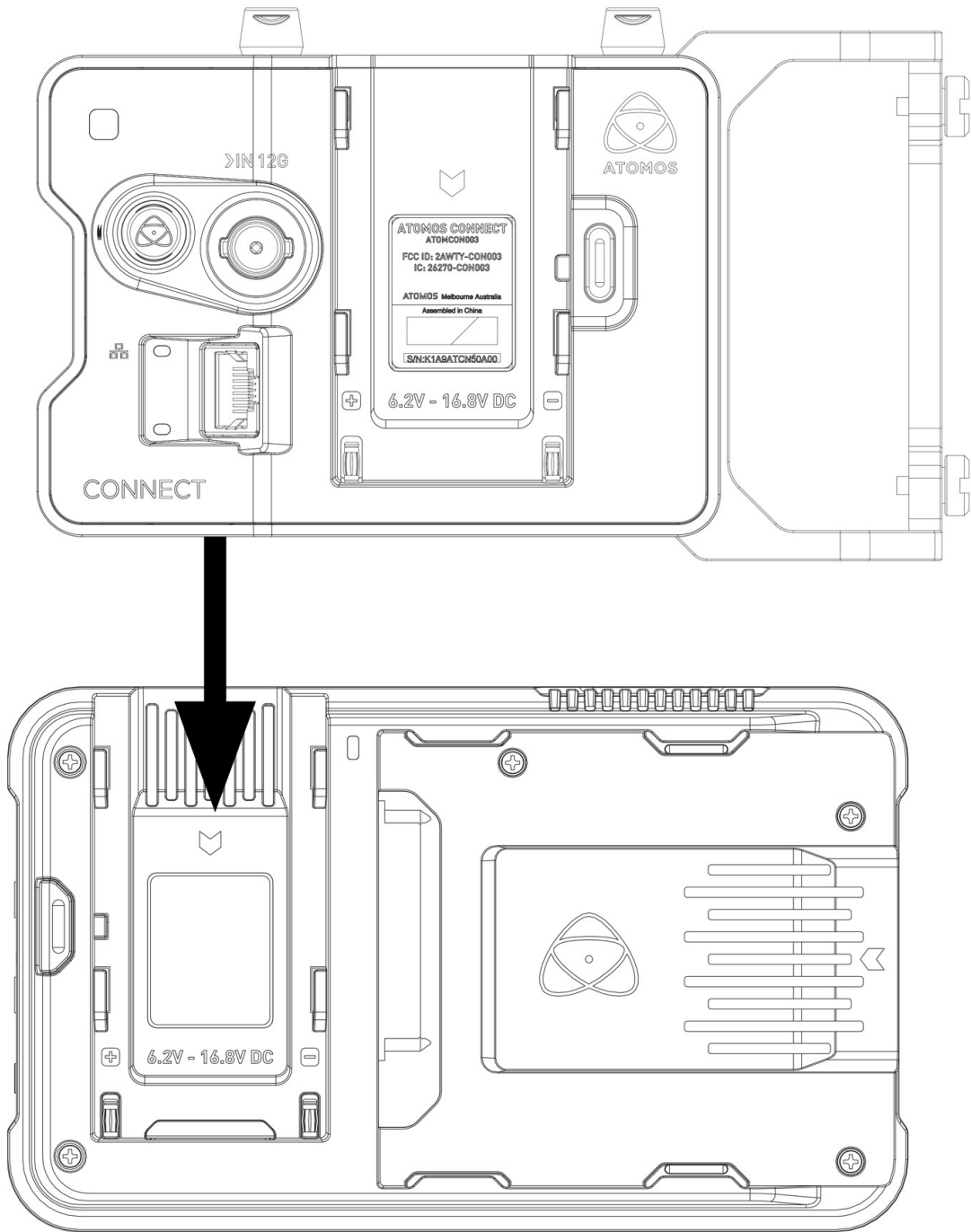

2. Gently slide ATOMOS CONNECT into the AtomXpansion port until it clicks into place.



*When mounting ATOMOS CONNECT, make sure that it clicks into place.*

3. Tighten the thumbscrews (h) to secure ATOMOS CONNECT in place.



*Take care not to over tighten the thumb screws.*

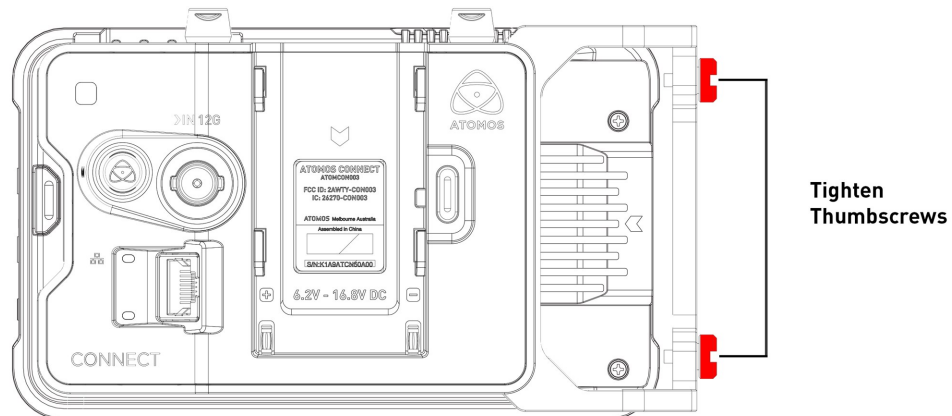

### **To remove ATOMOS CONNECT from your NINJA V:**



*Ensure that any inserted media is removed from your NINJA V before attempting to remove the ATOMOS CONNECT from your NINJA V.*

1. Loosen the thumbscrews completely (h).

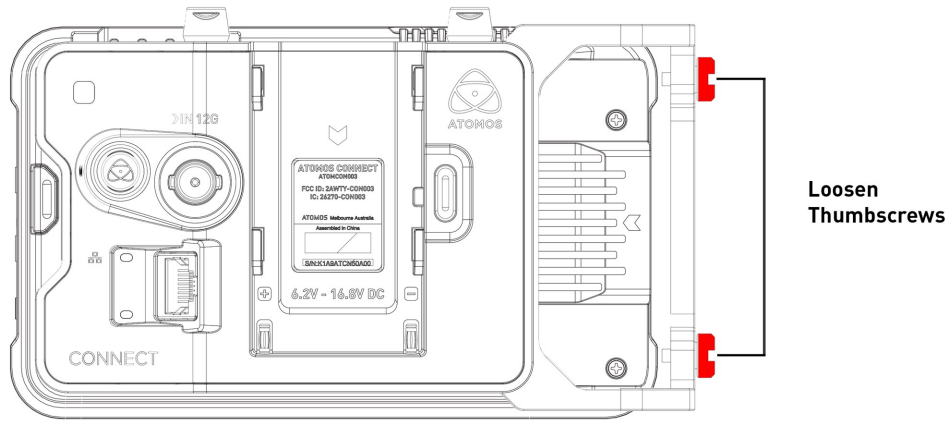

2. Press the release button on the NINJA V and gently slide the ATOMOS CONNECT upwards and away from the NINJA V.

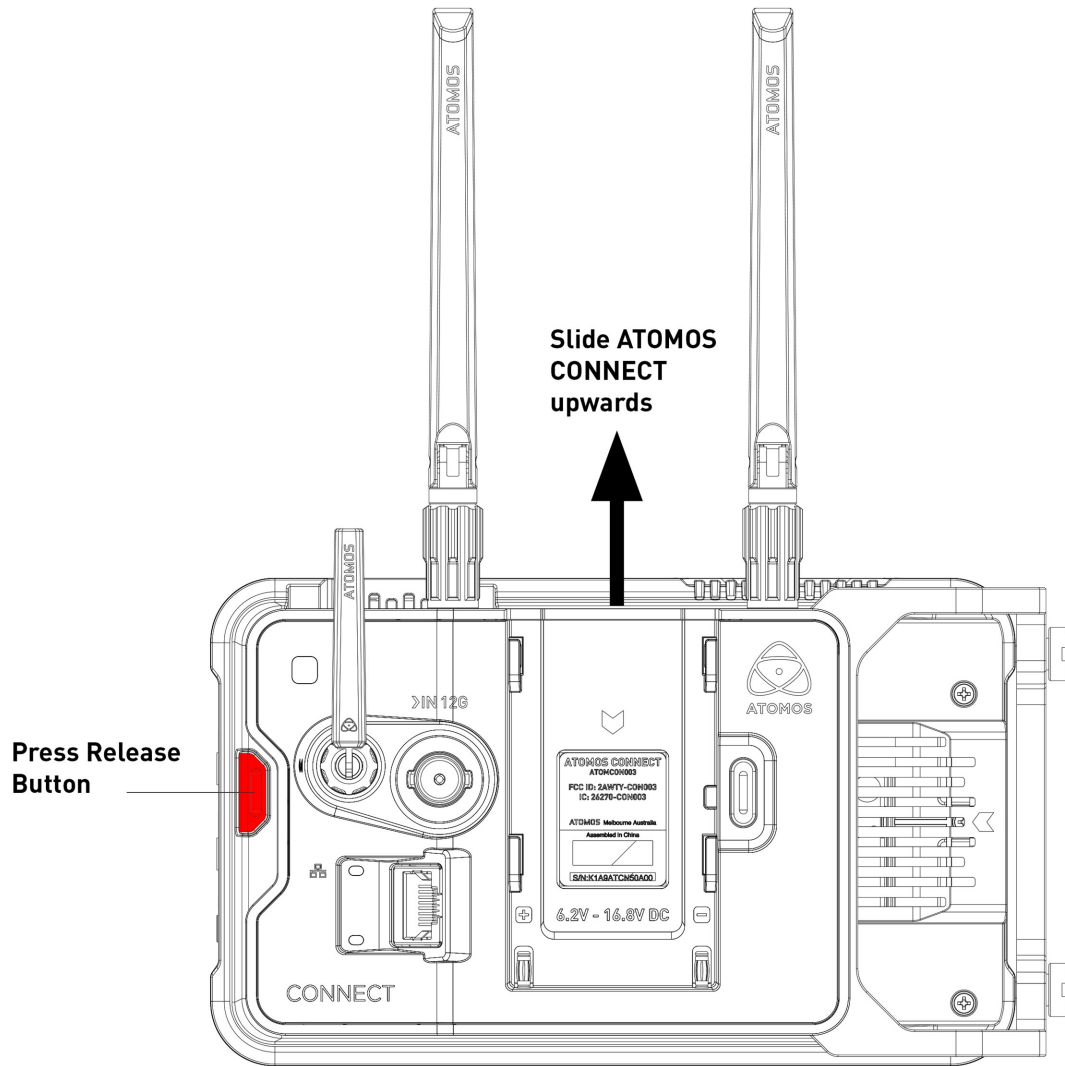

## Attaching the Antennas to ATOMOS CONNECT

There are three antennas inside the ATOMOS CONNECT box. Two of the antennas are identical in size and shape and one is smaller in length. The two longer antennas are the Wi-Fi antennas, and the smaller antenna is the RF antenna.



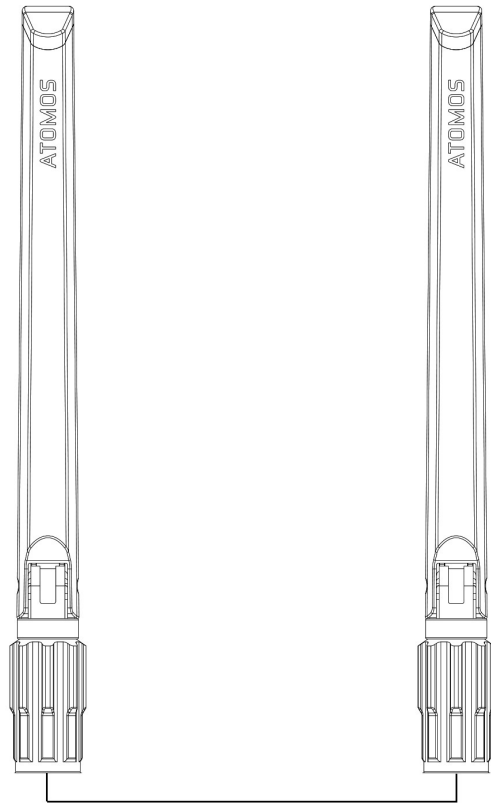

**Wi-Fi Antennas**



**RF Antenna**

1. Unscrew the Antenna mount covers from the positions indicated, and store them in a safe place. When the antennas are not attached, these covers should be screwed in place to protect the antenna connectors.

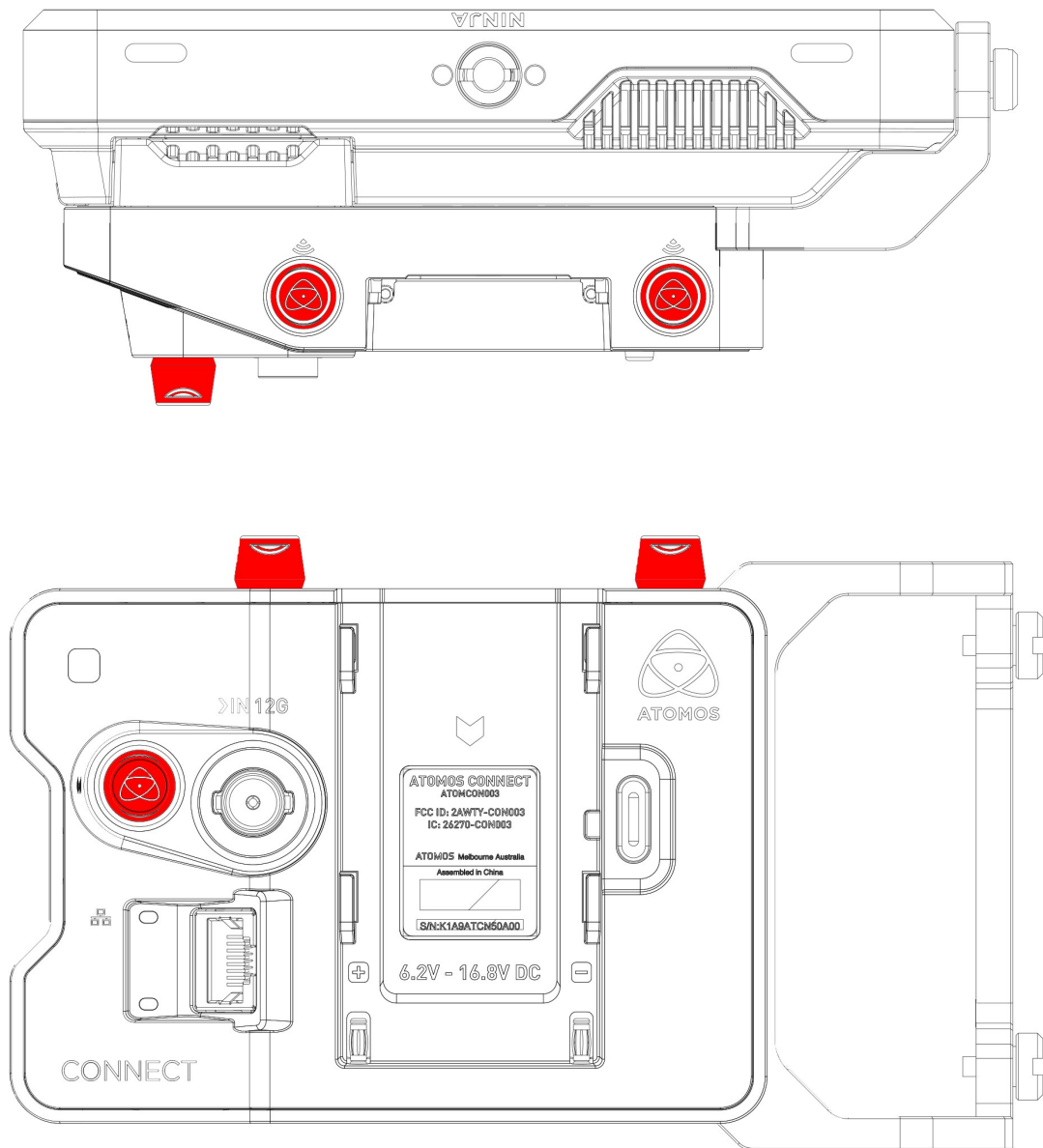

2. Screw the 2 x Wi-Fi antennas into the Wi-Fi connectors on the top of ATOMOS CONNECT.

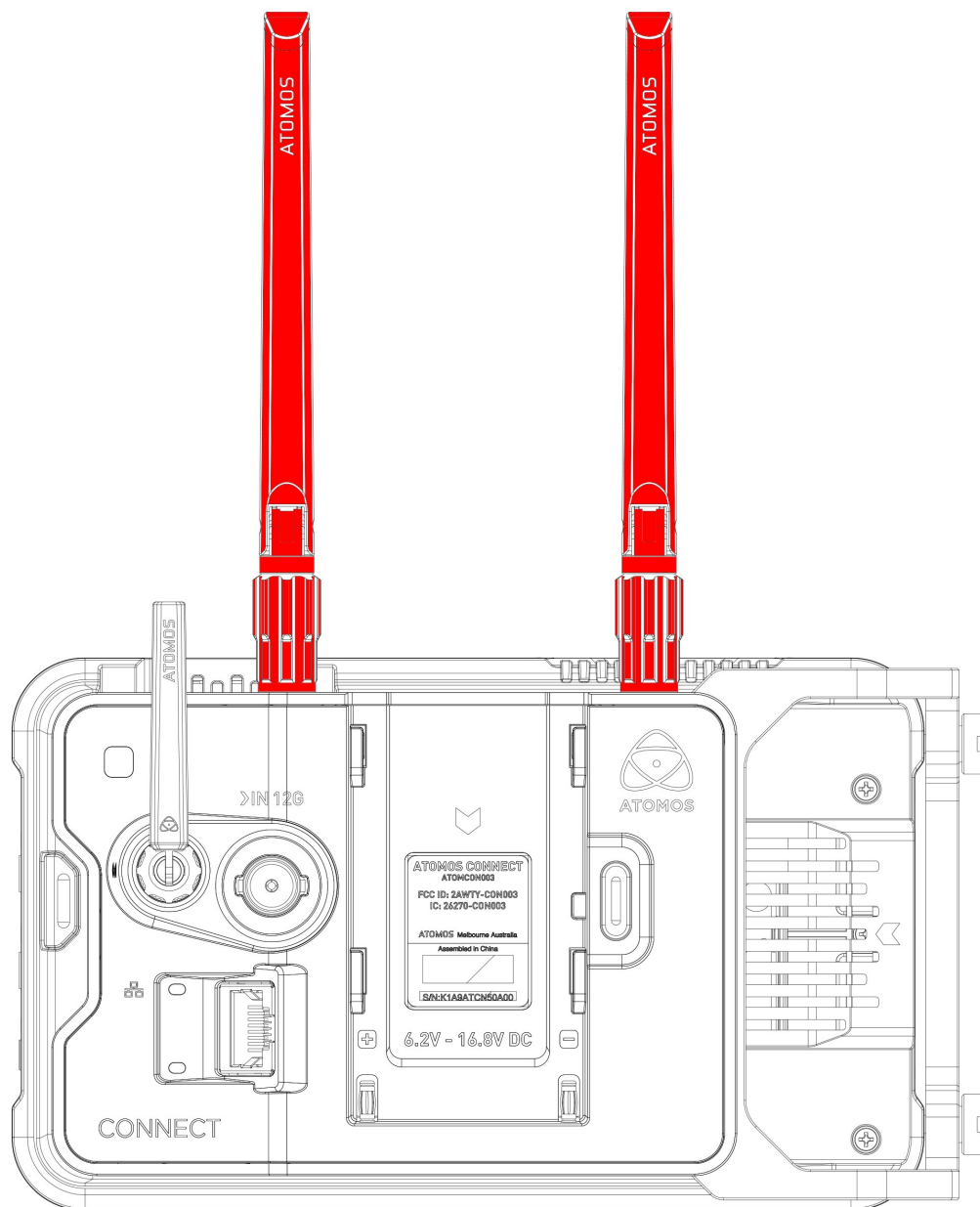

3. Screw the smaller antenna into the RF connector on the back of ATOMOS CONNECT.

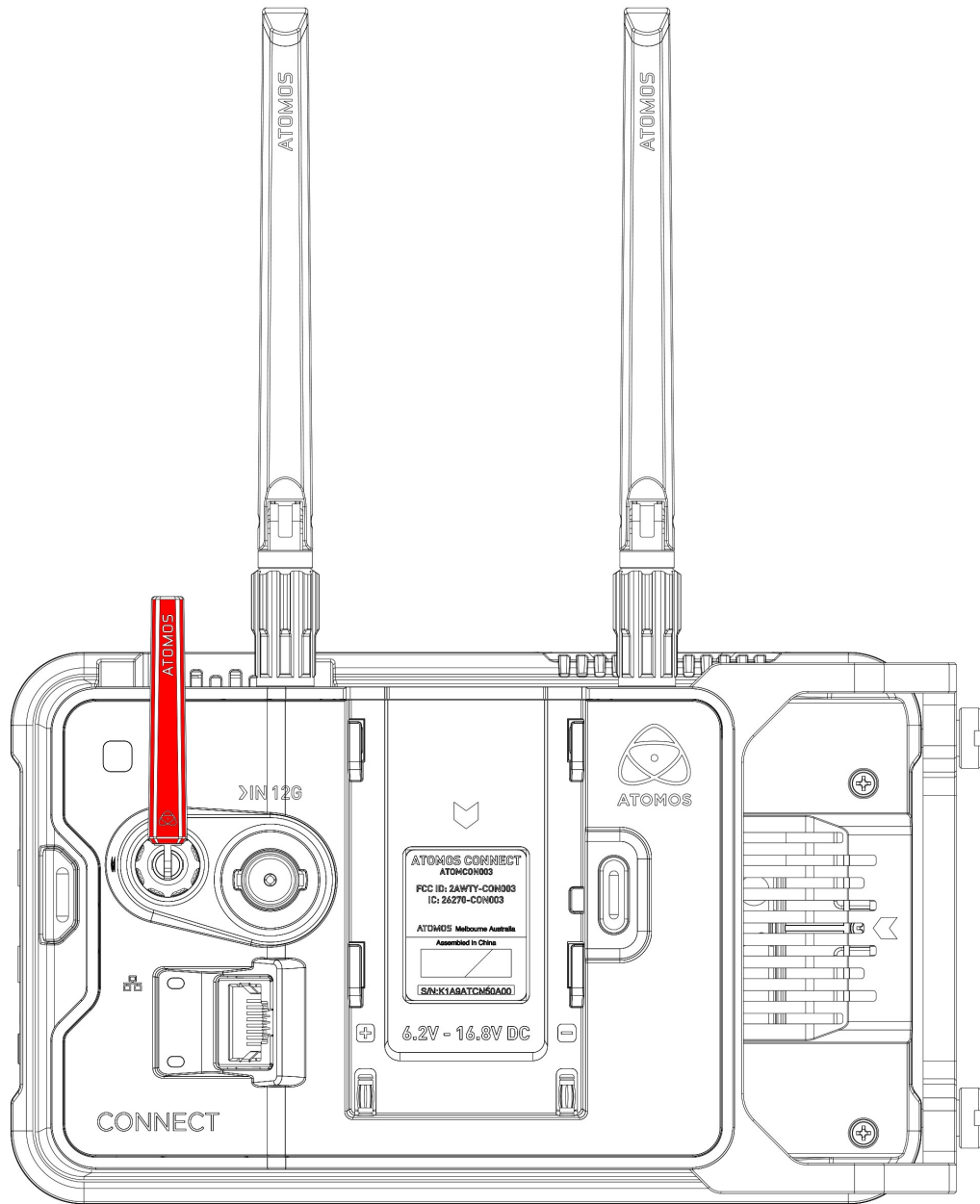

## Attaching Power to ATOMOS CONNECT

The ATOMOS CONNECT can be powered by the DC Power Supply and Battery Eliminator that were supplied with your NINJA V, an optional D-Tap to DC Barrel Coiled Cable (ATOMDTPCB2) or NP-F / L-Series type batteries. Connect your chosen power source to

the battery slot (f) to provide power in the same way you would attach a power source to your NINJA V.



*Connecting a power source to the ATOMOS CONNECT supplies power for both NINJA V and CONNECT.*



*The first time you power on your NINJA V with ATOMOS CONNECT attached, you will be prompted to select your region of use. Tap Region to cycle through the options and then tap on Confirm. This message will also appear after performing a factory reset and after installing new AtomOS firmware.*

### **To attach an NP-F / L-Series type battery to ATOMOS CONNECT**

- Place the battery in front of the retaining lug, align with the connectors and slide the battery into the battery slot (f) until it clicks into place

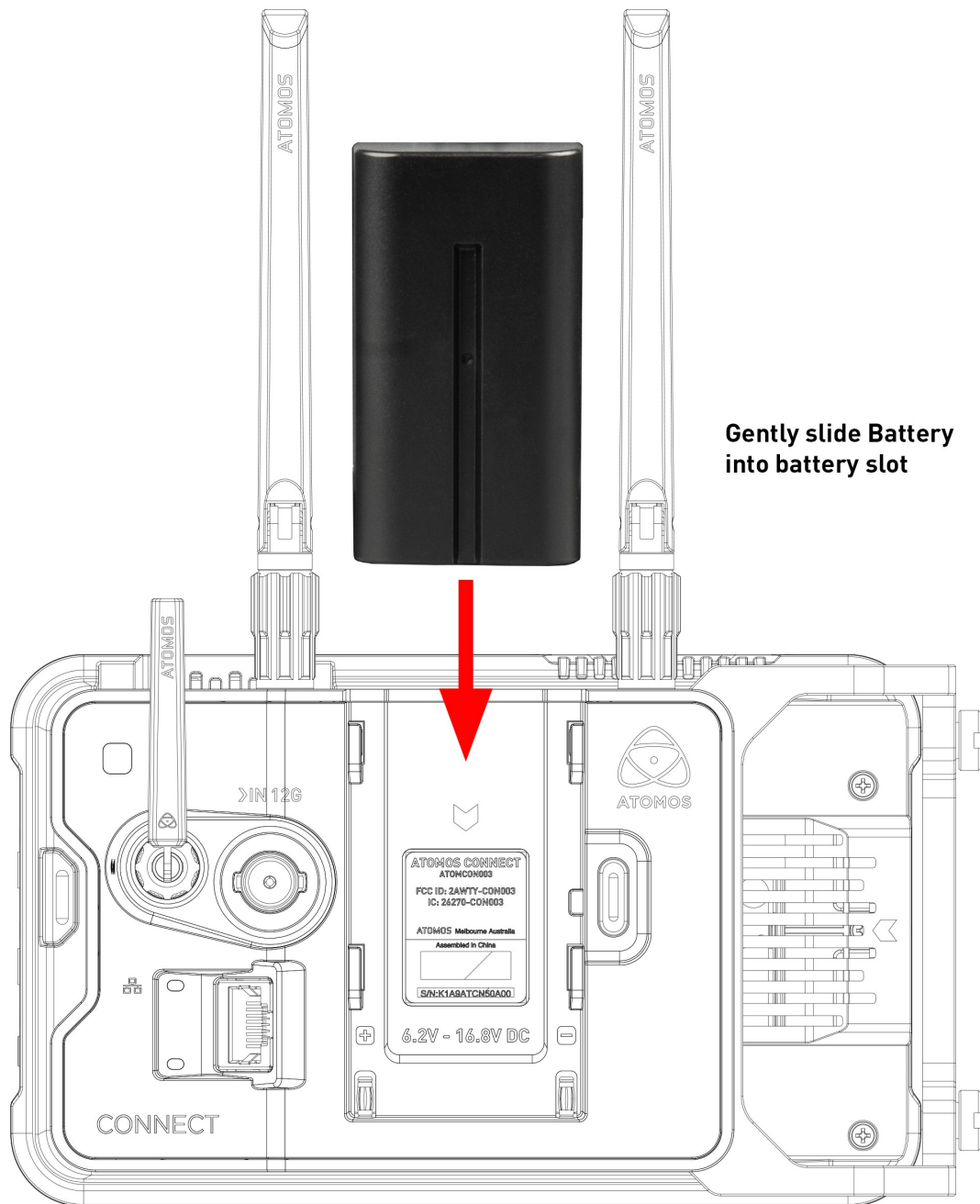

**Gently slide Battery into battery slot**

**To attach a Battery Eliminator to ATOMOS CONNECT**

- Gently slide the Battery Eliminator into the battery slot (f) until it clicks into position.

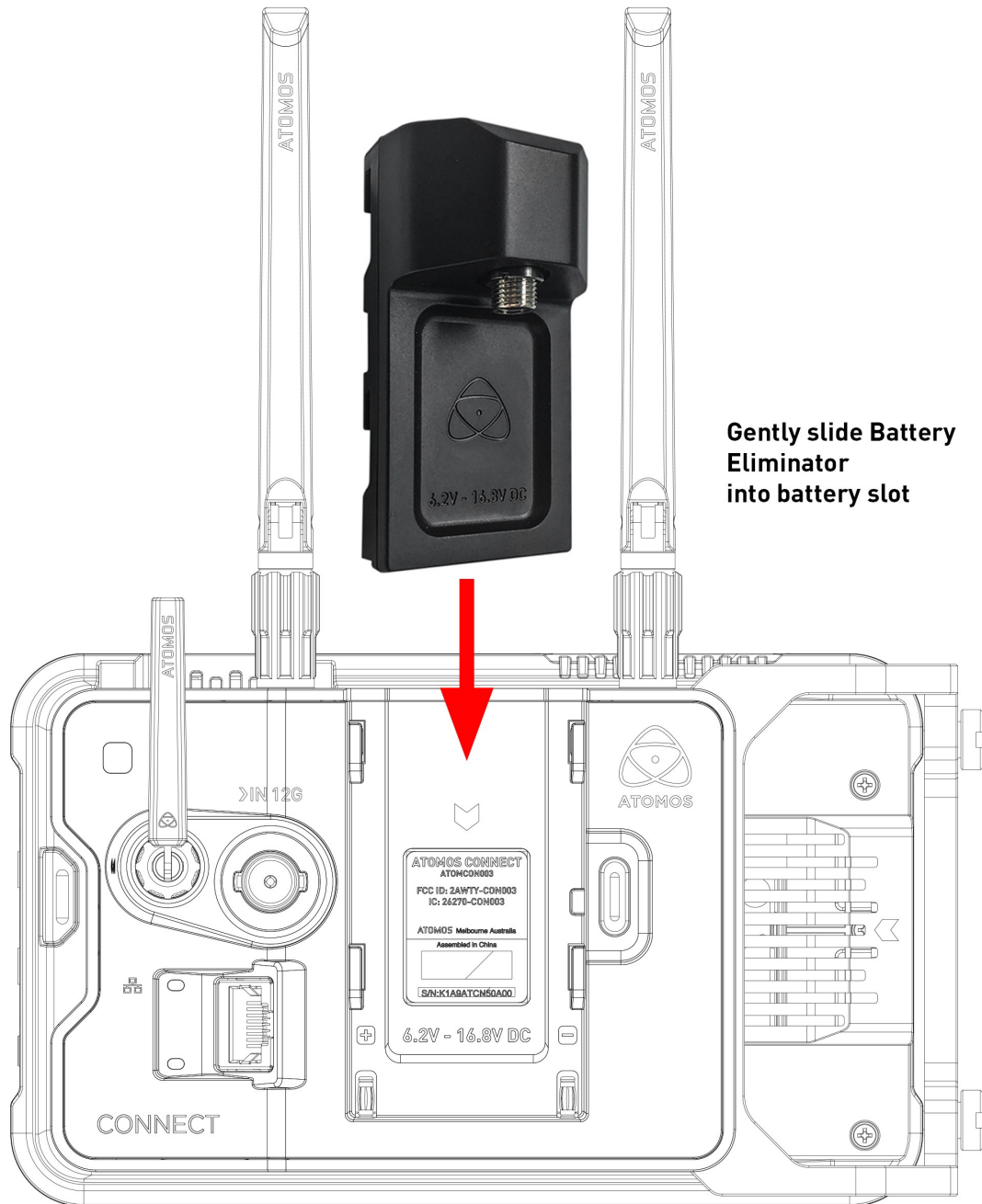

- Secure the DC power supply to the DC jack on the Battery Eliminator.
- Alternatively, secure the optional ATOMOS D-Tap to DC Barrel Coiled Cable (ATOMDTPCB2) to the DC jack and connect the other end to a D-Tap power source.

## To remove a Battery Eliminator or battery from ATOMOS CONNECT

- Press the battery release (g) and gently slide the power source upwards to remove it.

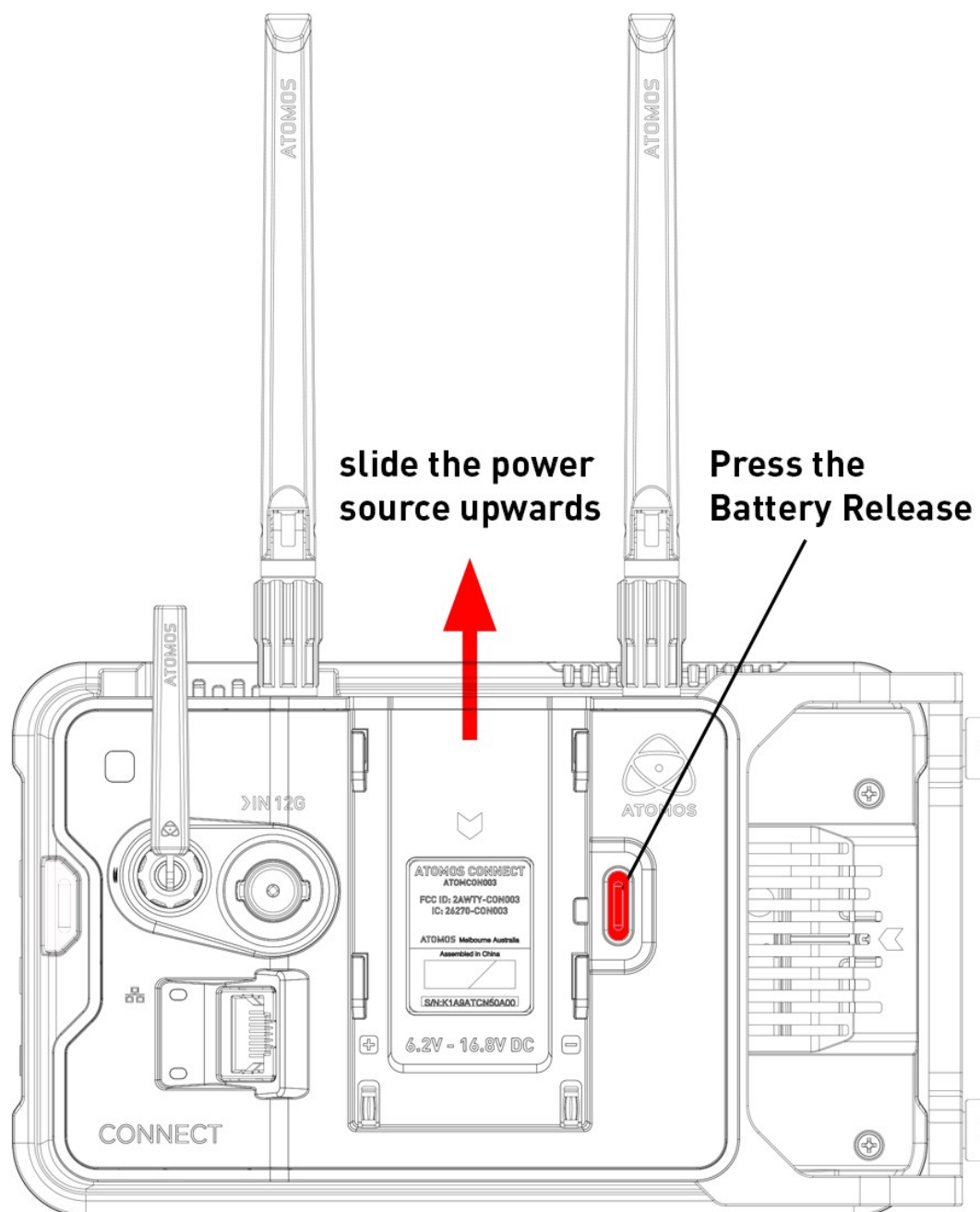



## **Connecting to the Atomos Cloud**

For information on how to connect to Wi-Fi or Ethernet networks, refer to the "Wi-Fi Menu" on page 123 and "Ethernet Menu" on page 128 pages. For information on the Atomos Cloud Studio and the procedure for connecting to the Atomos Cloud, refer to "Connect Menu" on page 132 and "Connect Menu - Atomos Cloud Studio" on page 144

# AtomOS 10 Operating System



With the AtomOS 10 Operating System, you get the ultimate touch interface for monitoring and recording and an operating system that has a clean, intuitive and elegant design. It's simple and straightforward, but at the same time it provides access to the complete range of features. No complicated sequences of buttons. No endless menus crowded with text. It's optimized for the AtomIC hardware platform. And it's extremely responsive with fast boot up times.



# The Main Screen - Home Screen

The ATOMOS 10 home screen is designed for unobstructed monitoring at all times. The clean and uncluttered design of ATOMOS 10 concentrates the attention on the image, not on the device's operation. From the muted main button controls through to flexible histogram size and positioning, all on-screen controls are non-obtrusive and incredibly intuitive to use. Monitoring tools are only one-touch away, and allow for a better view of your subject while adjusting monitor-assist functions such as focus peaking and false color, Record, Playback, Monitoring and Edit features are easier than ever to use.

## Monitor Mode / Home

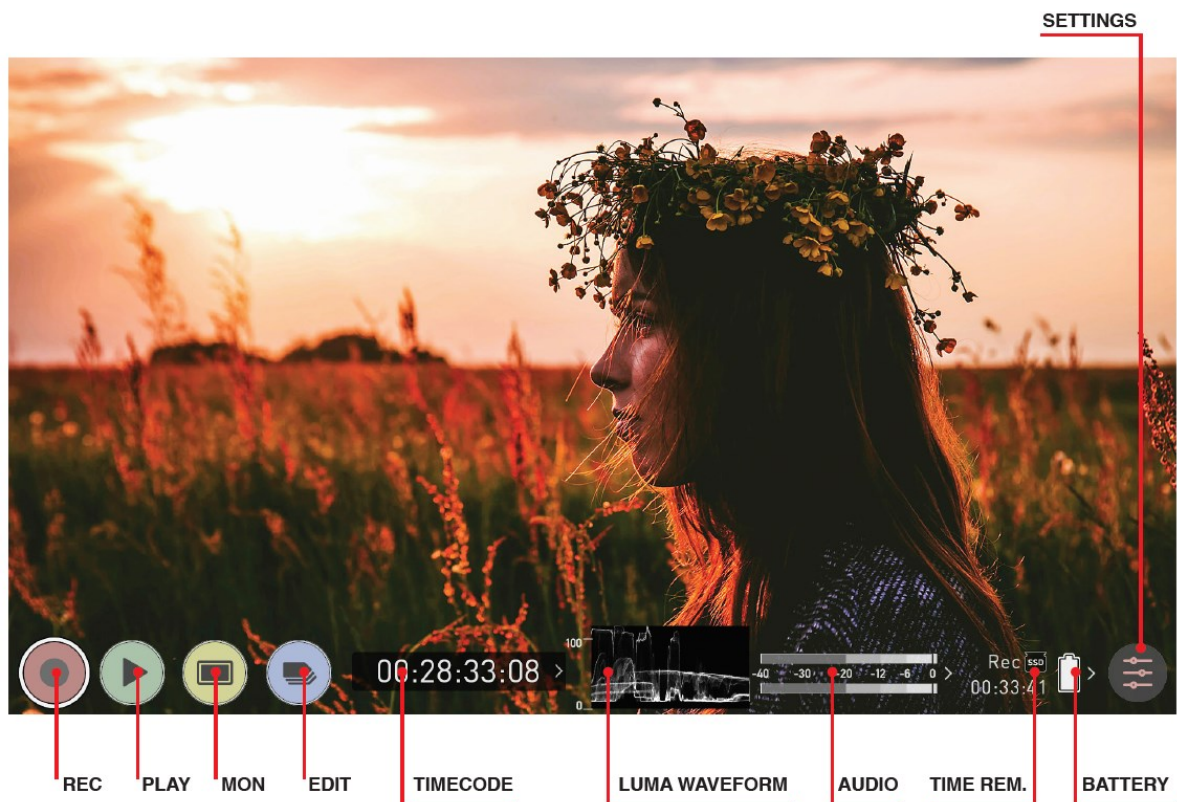

**REC (Record):** Press to begin recording. Jump to Record Home Screen.

**PLAY:** Jump to the most recently recorded clip on the Playback Home Screen.

**MON (Monitor):** Press once to show Monitoring Features and Information Bar. See the following pages for activating Monitoring features. Press again to return to home.

**EDIT:** Press to show Editing Features and Information Bar. Press again to return.

**TIMECODE:** Shows the selected timecode such as embedded, time of day or rec run.

**LUMA WAVEFORM:** Luma Waveform is a constant on your home screen, to allow for greater control over monitoring without compromising the subject.

**AUDIO:** Audio Meters. Touching the Audio meter will open the Audio Menu.

**TIME REMAINING:** Time Remaining on Disk (at current record settings). Changing Recording Format will change Time Remaining.

**BATTERY:** Touch to access Power Menu. Battery Indicator shows power level and flashes red when power is running low.



**SETTINGS** (red): Touch to access all Recording settings, including input, output, file, media, gamma, gamut, and more.



Touch **MON** (Monitor) to reveal Monitoring Features and the Information Bar. When activated the Monitor button will have two surrounding rings. For more information refer to "The Main Screen - Monitoring Features" on page 79



*At any time you can remove the overlays by touching the center of the screen. Touch again to bring them back.*

# The Main Screen - Information Bar

At the top of the NINJA V screen is the area referred to as the **Information Bar**.

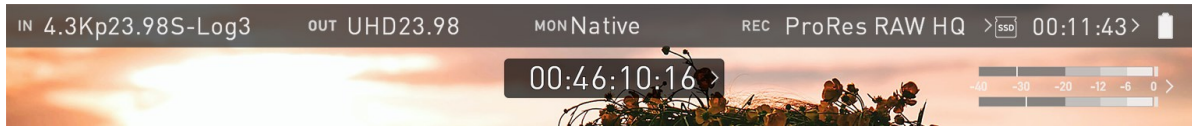

It displays the settings of your input device/camera, current settings of your NINJA V, media, audio, disk capacity and more. Touching any of these areas will take you to the relevant menu and allow you to make changes to your setup.

Alternatively you can access these setting by tapping the Record Settings icon. Tapping the Settings button will open the Record Settings menu, from where you will be able to navigate to the required tab. Swipe left to see more tabs.



The content in the Information Bar is dependent on what mode you are in, for example Recording and Monitoring will display the Video Input type, but if you are in Play mode, Video Input will show the resolution and frame rate of the video clip currently cued or playing.

## Monitor Mode / Features

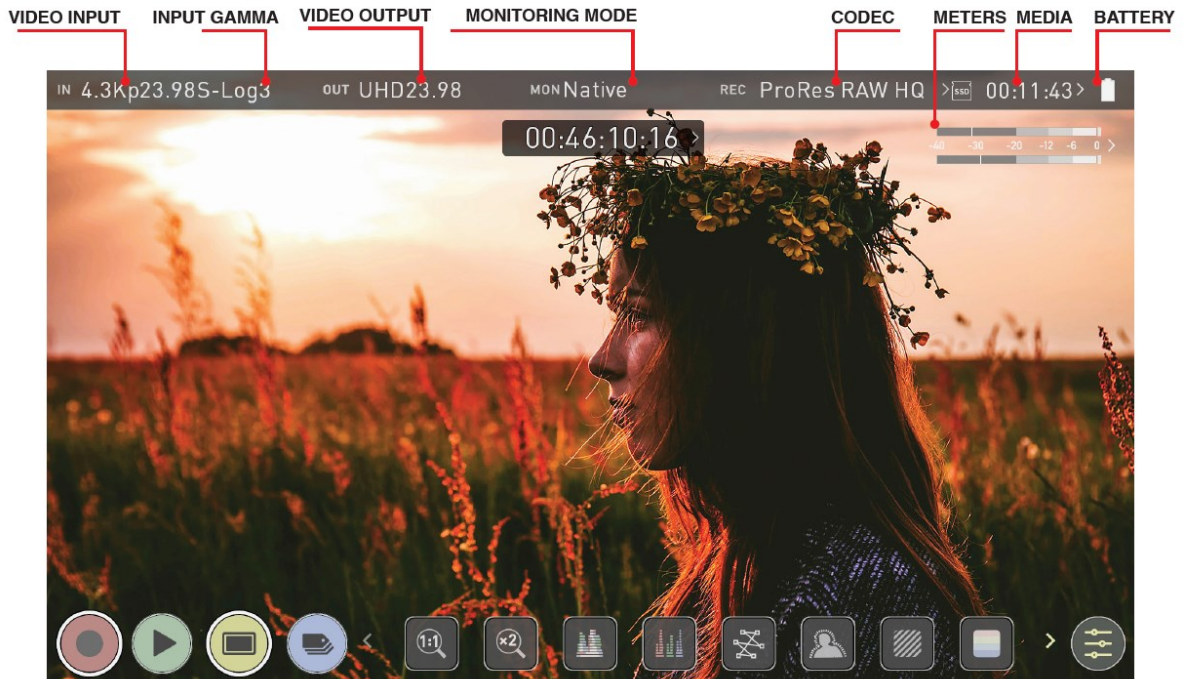

*In the image the NINJA V has an input and an output, and is ready to record the signal or play the last recorded file from disk.*

**VIDEO INPUT: (Rec & Mon mode)** Resolution and frame rate from input device

**VIDEO INPUT: (Play & Edit mode)** Resolution and frame rate of current playback clip

**INPUT GAMMA:** Displays the current input gamma. Tap to open Input menu to ensure it matches the output coming from your camera or other input device. RAW inputs will automatically be set to match the camera output. For some cameras further options can be selected. During playback mode this setting will be determined by the metadata of the recorded content.

**VIDEO OUTPUT:** This menu displays the active video resolution and frame rate being output from the HDMI Out.

**MONITORING MODE:** Displays the monitoring display mode that has been selected. Native, Rec709, HLG, PQ or the name of the 3D LUT selected. Touch to change settings.

**CODEC (RECORDING FORMAT):** Shows the recording format. Touch to change settings.

**METERS: (Audio Meters):** Touching the audio meters will open the Audio Menu.

**MEDIA INFO:** This shows the remaining recording time based on the chosen codec and remaining capacity of the drive.

**BATTERY:** Touch to access Power Menu. Battery Indicator shows power level and flashes red when power is running low.

## NETWORK STATUS

When you are in Connect mode, the following network status icons will appear in the Information Bar. These icons represent Wi-Fi and Ethernet connections, and will appear white when active.



**SETTINGS** (yellow): Touch to access Monitoring Feature settings.



Touch MON again to return to previous screen.



*The EDIT button works in a similar fashion to the Mon button, as it is not possible to have Monitor and Edit active simultaneously.*

# The Main Screen - Monitoring Features

At the bottom of the Monitoring screen are the Monitoring Features, accessible by toggling the MON icon. Monitoring Features do not affect your recorded file and can be turned on and off, or adjusted whilst recording (unless you choose to burn a LUT into your footage). Not all Monitoring features are available at first glance – to reveal all Monitoring features, swipe monitoring icons to the left. The icons will behave in a carousel like manner and you can swipe left and right to access any of the features. At the bottom right is the Settings button. Press the yellow Settings icon to adjust the settings and behaviors of the Monitoring Tools.

## Monitor Mode / Features

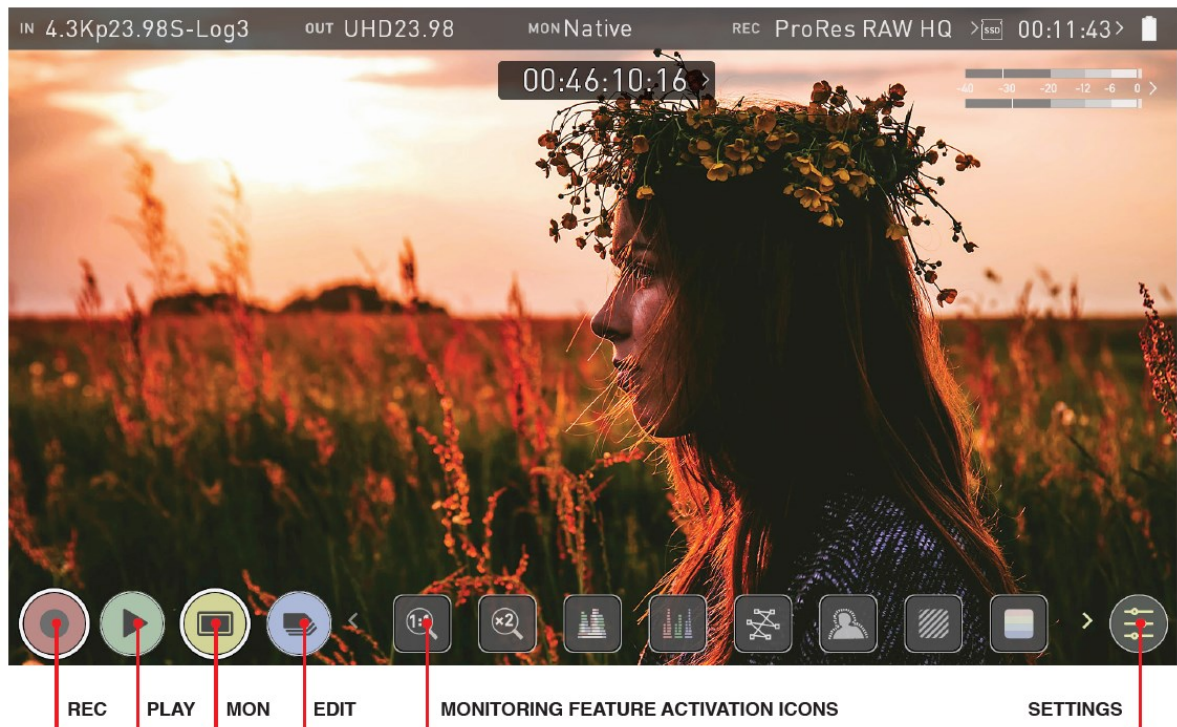

### Main Controls



REC (Record): Tap to begin recording / Return to Record Home Screen.



PLAY: Jump to the most recently recorded clip / Enter Playback Home Screen.



MON (Monitor): Whilst on the monitoring features screen press once to revert to home screen view. For Monitor settings press the Settings button.



Any Monitoring functions you have enabled will remain active until deactivated.



**EDIT:** Press to show Editing Features and Information Bar.

Press again to return to home. Any Monitoring functions you have activated will remain active until they are turned off.



**SETTINGS (yellow):** Touch to access Monitoring Feature Settings. Set scope sizes, adjust transparency, LUTs, Focus Peaking and more.

## Monitoring Feature Activation Icons



Zoom In



Zoom x2



Luma Waveform



RGB Parade



Vectorscope



Focus Peaking



Zebra



False Colour



Blue Only



Safe Area



Guides



De-squeeze



Settings



Swipe left to reveal

For more information on the monitoring tools, refer to the Monitoring Features section.

# Home screen and menu functions

## REC (Record)

This is the icon you touch to begin a recording. Touch it again to stop a recording. While recording the Rec icon changes to a Stop icon and a red frame is present around the screen.

### Standby

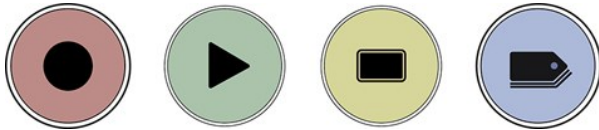

### Recording

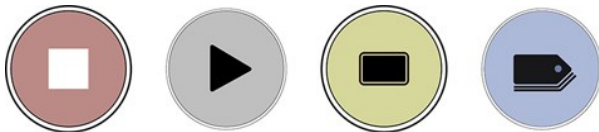

### No input / No media



*The Rec icon is dimmed and disabled if there is no valid video input. It also appears in where there is no media, the disk is not formatted or the disk is full. The button is dimmed because you cannot record.*

## PLAY

Touch this icon to play previously recorded clips and touch it again to pause playback. When you press the green Play button the NINJA V will switch to playback mode and automatically play the last recorded clip.

### Playback Mode

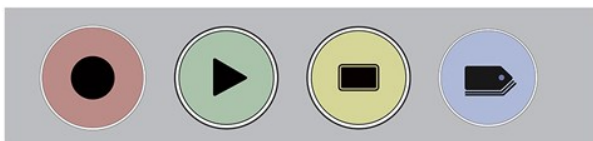

## Playback Home screen

Touching the folder icon will reveal the available playlist.



NINJA V uses a unit name, scene, shot and take convention to name the clips. Select the clip you want to play by touching the file name and this will start to playback. To exit the playlist simply touch close, or any other button. Touching close will take you to the previous window.



### Close Screen

Tap to close the screen.



### Folder level up

Tap to navigate one level up in the folder structure.



### Playlist Options

Tap to enable Playlist options. For more information on using playlists, refer to "Playlists" on page 341

## No disk / disk not secure



*The Play button will be dimmed and disabled if there is no disk, where there is a poor connection or the disk is not correctly formatted and during recording. See the "Best Practice" on page 19 section for more information.*

## MON (Monitor)

Pressing MON reveals Monitor Assist icons as shown in "The Main Screen - Monitoring Features" on page 79 section. These features are explained in detail in the Monitoring Features section.

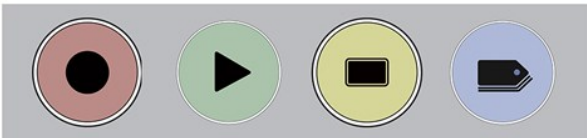

## EDIT

You can use the edit tools during recording and playback. Pressing EDIT takes you into a number of options. For more information refer to the "Edit Mode" on page 349 section.

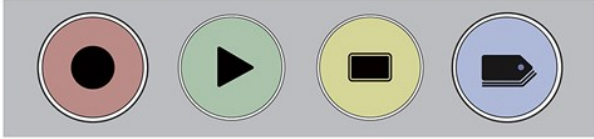

# The NINJA V Menu system

Tap on the Input, Output, Codec, Media or Battery indications in the Information bar at the top of the home screen to open the menu related to that item.

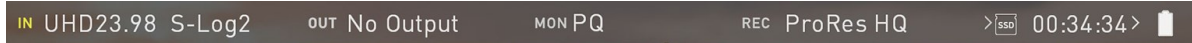

Menu pages contain information as well as settings that can be adjusted.



Across the top of the menu page that opens are menu tabs that link to the other menu pages. Swipe the menu tabs to the left or right to see all of the menu tabs and tap on the one you wish to enter.



Swipe left to reveal more tabs that contain settings. If you cannot find the menu you are looking for, swipe left or right.

# Source Menu

The Source menu allows you to select your Input Source, depending on your signal connection and how you are using your NINJA V.

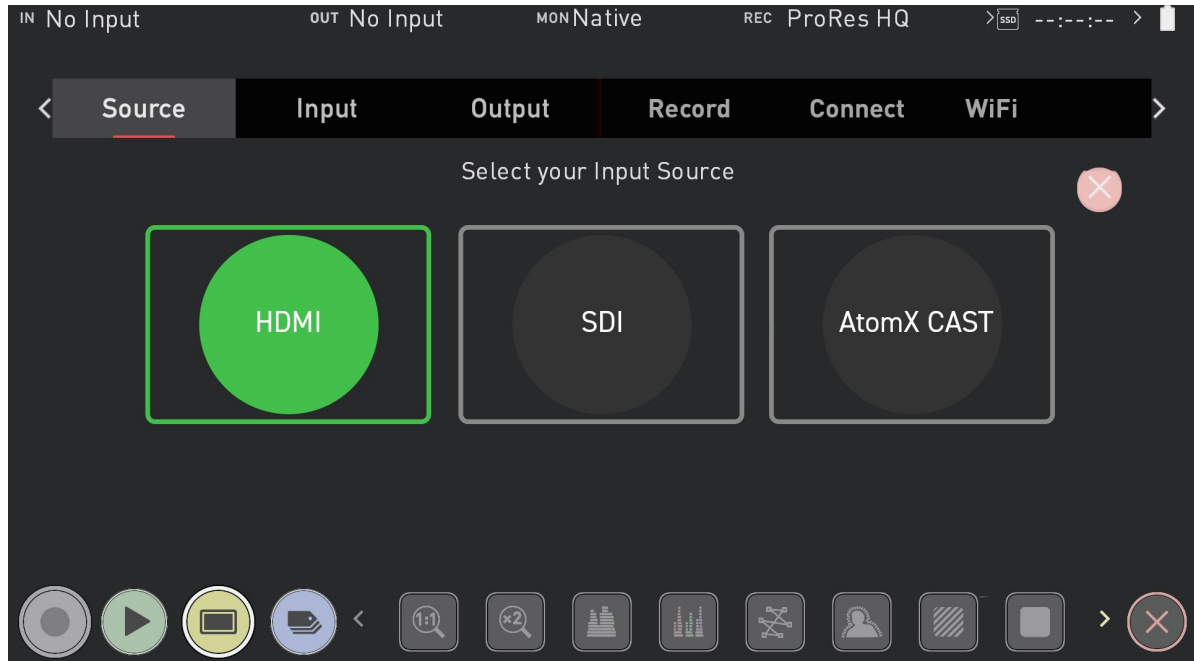

## Select your Input Source

Select your Input Source from the options below. Once you have made a selection, tap OK and your NINJA V will power down and reboot in the selected mode. Press cancel to return to the selection screen.

### HDMI

Selects the HDMI input on your NINJA V. This mode should be used for standard NINJA V operation when you do not have AtomX CAST connected.

### SDI

For SDI sources connected to an AtomX SDI Module or ATOMOS CONNECT that is attached to your NINJA V. To be available for selection, an an AtomX SDI Module or ATOMOS CONNECT needs to be connected before turning on the NINJA V.



## AtomX CAST

Select to use the features of the AtomX CAST. To be available for selection, the AtomX CAST module needs to be connected to the NINJA V before powering it on.



*When AtomX CAST is connected to your NINJA V, the AtomX SDI option will be greyed out since you cannot use the SDI module when the AtomX CAST is attached.*



*RAW inputs are not supported when using the AtomX CAST for switching.*



*If you power on NINJA V after using the AtomX CAST mode, you may see a warning notifying you that an AtomX CAST module has not been detected. You will be advised to Power Off your NINJA V and attach the module, or to change modes and operate without the module.*

# Input Source

The source section allows you to select the input signal connection type, and related settings.

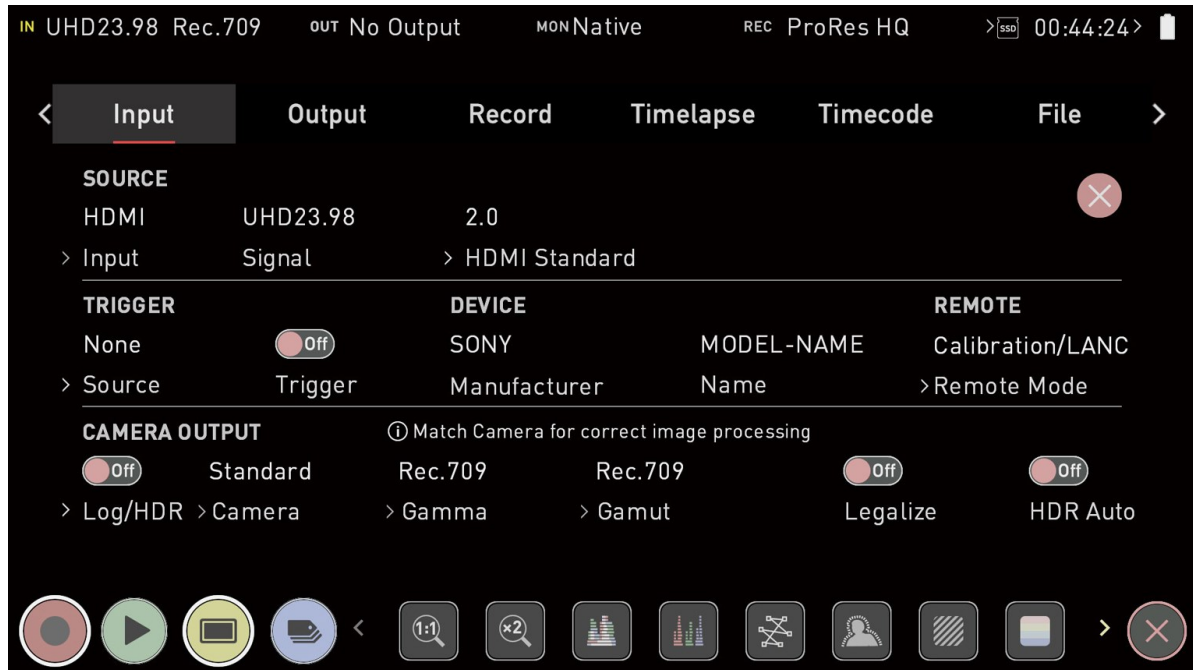

## Input

When you have an AtomX SDI module or ATOMOS CONNECT attached to your NINJA V, you will be able to tap on Input to switch between HDMI and SDI inputs. For more information refer to "Input via AtomX SDI Expansion Module" on page 91 and "Input via Atomos CONNECT" on page 93



*You can only switch from HDMI input to SDI input when the AtomX SDI Expansion Module or ATOMOS CONNECT is connected to your NINJA V.*

## Signal

The resolution and frame rate of the selected input source is displayed. No Input will be displayed when there is no input connected.

## HDMI Standard

When connected to an HDMI source, tap on HDMI Standard to toggle between the following:

- HDMI 1.4,
- HDMI 2.0 and
- Compatibility Mode.

### Compatibility Mode (HDMI)

This mode improves the signal locking process when working with HDMI signals from specific cameras. After selecting compatibility mode, remove and re-insert the HDMI cable to the camera.



*Compatibility mode should be enabled when recording from a Z CAM E2 series camera via HDMI, for all frame rates and resolutions in ProRes, DNx and ProRes RAW. It should also be enabled when recording video from a Canon 1DX MIII via HDMI, in 4Kp50 and 4Kp60 modes in ProRes and DNx.*



*Compatibility mode for HDMI should not be used for any HDMI RAW signals except for Z CAM E2 series cameras and the Canon EOS R5.*

# Input via AtomX SDI Expansion Module



The AtomX SDI expansion module adds 12G SDI I/O to your NINJA V with 2 x industry standard full size BNC connectors. When you have an AtomX SDI module attached to your NINJA V, you will be able to tap on Input to switch to SDI as your input. You will then be prompted to reboot your NINJA V so that it can change to the SDI input. Tap Confirm and wait for your device to reboot in SDI source mode.

Once in this mode, the input menu will resemble the image shown above. The AtomX SDI Module does not need to be activated before use, however to use the SDI RAW feature you will need to activate this feature. Refer to the "Activation Menu" on page 224 section for more info.



*You can only switch from HDMI input to SDI input when the AtomX SDI Expansion Module or ATOMOS CONNECT is connected to your NINJA V.*



*To use the AtomX SDI Module with your NINJA V, firmware version 10.1 or later needs to be installed. To use SDI RAW, firmware version 10.6 or later needs to be installed.*

## Mode

When connected to an SDI source, tapping on Mode will toggle between the following modes:

- **Single Mode:** For single SDI sources, where a single SDI input on either the Channel 1 or Channel 2 connector.
- **Dual Mode:** Selects both SDI connectors to deliver the input signal as a dual-link connection, where two SDI cables are connected for dual link 1.5G/3G and 6G standards.
- **Auto Select:** Your NINJA V automatically detects the correct mode to use, based on the signal that it is receiving.
- 

## Channel Source / Link Status

In Single Mode, a Channel Source indicator will appear and display the currently selected channel. Where you have two different SDI sources connected, you can tap Channel Source to switch between SDI connector 1 and 2. Single link SDI connections will automatically be configured based on the signal input between 12G/6G/3G/HD.

In Dual mode, a Link Status Indicator will display the status of your signals. Channel 1 and/or 2 will be red when the signal is not present, whilst they will both be green when both receiving a signal.

## Compatibility Mode (SDI)

Where SDI has been selected as your input, a Compatibility Mode toggle switch will be visible under Source. This mode improves the signal locking process over SDI, when working with specific cameras that use a slightly different version of the 12G standard. For more information refer to [atomos.com/support](https://atomos.com/support)

# Input via Atomos CONNECT



With the ATOMOS CONNECT attached, you will be able to tap on Input in the Input Menu to switch to SDI as your input. The Source Menu will open, where you can select SDI. A note will advise that changing input source will take a few seconds. Tap Ok and wait for your device to switch to SDI source mode. Once in this mode, the input menu will resemble the image shown above.

The ATOMOS CONNECT features a connector for 12G SDI input, which allows you to monitor and record SDI video up to 4Kp60 from a range of professional cameras and video sources.



*To use the ATOMOS CONNECT with your NINJA V, firmware version 10.8 or later needs to be installed. To use SDI RAW, firmware version 10.6 or later needs to be installed.*

To use the SDI RAW feature with ATOMOS CONNECT you will need to activate this feature. Refer to the "Activation Menu" on page 224 section for more information.

## Compatibility Mode (SDI)

Where SDI has been selected as your input, a Compatibility Mode toggle switch will be visible under Source. This mode improves the signal locking process over SDI, when working

with specific cameras that use a slightly different version of the 12G standard. For more information refer to [atomos.com/support](https://atomos.com/support)

# Trigger

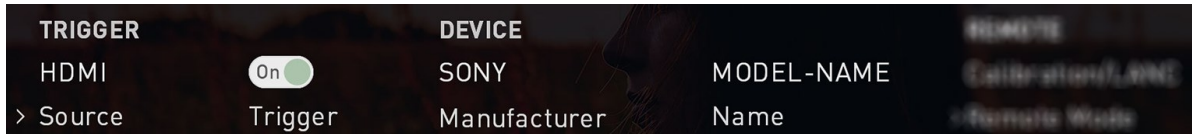

## Source (Trigger Source)

The NINJA V can be remotely triggered to record from your camera. For HDMI inputs, tap Source to cycle through the following trigger sources:

- **HDMI:** If HDMI timecode is selected, you have the choice to start and stop recording remotely from the source camera timecode.
- **None:** Select to disable the record trigger.
- **Timecode:** For older cameras or cameras that don't have Start/Stop flags for triggering recording, the rolling timecode trigger will trigger recording automatically on the NINJA V when it detects rolling timecode on the camera.
- **Camera Manufacturer:** When you have an AtomX SDI module attached, and have selected SDI at Input, you will be able to tap Source to cycle through camera manufacturers as well as Timecode or None as the source of a trigger.

## Trigger (On/Off)

Where you have selected Timecode as the trigger source, you can enable or disable the trigger by tapping the ON/OFF switch.



*Note that where you have selected a camera manufacturer, you cannot disable the trigger*



# Device

A screenshot of a control panel interface. On the left, there are several buttons: 'SOURCE', 'HDMI', 'Source', and 'Trigger'. The 'Trigger' button is highlighted with a green glow. In the center, the text 'DEVICE' is displayed above 'SONY' and 'MODEL-NAME'. Below 'SONY' is the label 'Manufacturer' and below 'MODEL-NAME' is the label 'Name'. On the right side, there are buttons for 'CALIBRATION', 'Calibration/ANE', and 'Remote Mode'.

DEVICE	SONY	MODEL-NAME
Manufacturer	Name	

- **Manufacturer:** Displays the camera or device manufacturer.
- **Name:** HDMI Devices will display an EDID Device name if the information is available from the HDMI device connected. Not all cameras carry an EDID device name. For cameras such as the Panasonic LUMIX GH5 this will display as 'Unknown'.

# Remote

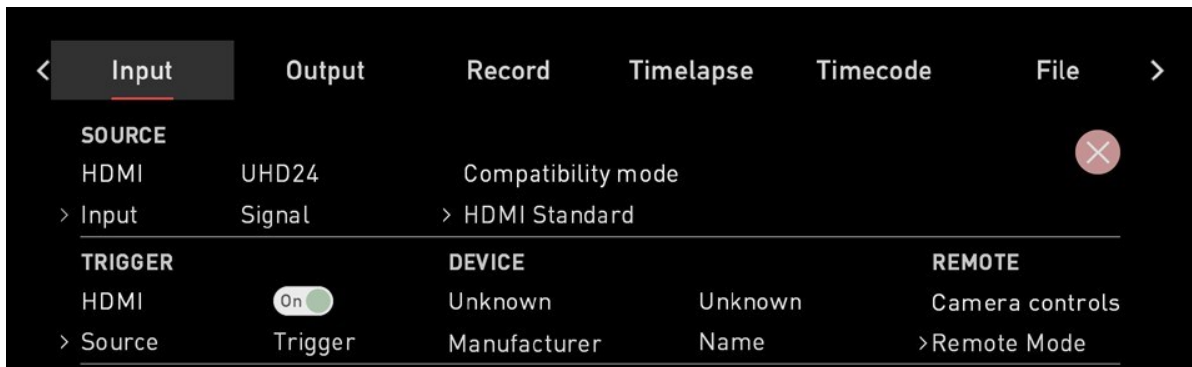

## Remote Mode

Tap to cycle through the options:

- **Camera Controls:** Allows you to control supported cameras via the screen of your NINJA V. Refer to the section below for ATOMOS Camera Menu Control for ZCAM Series cameras.
- **Calibration:** Every brand of monitor in the field and in the editing suite naturally drifts in color over time. ATOMOS have partnered with calibration leader Calibrite to open up professional monitor calibration to all filmmakers. For information on how to calibrate your NINJA V and to purchase a Calibrite i1 Display Pro, visit [atomos.com/accessories/x-rite-i1-display-pro](https://atomos.com/accessories/x-rite-i1-display-pro)
- **Lanc:** For remote operations via the Remote/Calibration Port, ATOMOS supports both LANC in Sony and Canon format. The NINJA V uses LANC Client so a LANC controller must first be attached to a camera and the output connected via a Y cable to the NINJA V.



*Calibration and LANC will appear as one option: 'Calibration/LANC'*

## ATOMOS Camera Menu Control for Z CAM Series cameras

When using your NINJA V with Z CAM E2 series cameras, you can control your camera via the screen of your NINJA V.

## How to enter camera control mode on NINJA V to control a Z CAM camera:

1. Use an HDMI cable that supports 4Kp60 to connect the output of the Z CAM to the HDMI input of your NINJA V.
2. Connect the 3.5mm end of an [ATOMOS USB-C to Serial LANC cable](#) to the Remote/Calibration Port on your NINJA V, and the USB-C end of the cable to the USB Type-C port on the Z CAM.
3. Power on your Z CAM and navigate to RAW over HDMI in the Record menu, to ensure that it is turned off.



*RAW over HDMI must be disabled for camera menu control to work.*

4. Power on your NINJA V and select Compatibility Mode in the Input menu at HDMI Standard. Remove the HDMI cable from the Z CAM and re-attach it to ensure that the signal is locked correctly.
5. Tap on Remote Mode on the Input page to select Camera Controls, then tap on the blue Camera icon on the bottom of the screen to enter camera control mode.



6. Your NINJA V will display the Z CAM camera settings and a camera battery status icon across the top of the screen, with audio meters and a Menu icon on the right hand side. The information that is normally displayed across the top of the screen like video input, media, timecode and battery status will now be displayed on the bottom of the screen.



### How to control a Z CAM camera with camera control mode on NINJA V:

Once you have entered the camera control mode, you can manually adjust the settings of your ZCAM from the display of your NINJA V. Tap one of the settings across the top of the screen like aperture, shutter speed, ISO or WB to bring up the adjustment arrows below the selected setting. Tap on the left or right arrow to adjust the values for the setting.

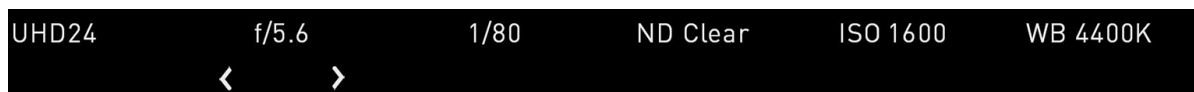

### Auto ISO / Auto WB

When you adjust the settings for ISO or WB, an additional Auto ISO or Auto WB icon will appear on the right side of the screen. If you tap on this icon, it will enable the automatic ISO or automatic WB mode respectively. The icon will have a white border, and an 'A' will be displayed beneath ISO or WB when enabled. Tap the icon again to disable the automatic mode.

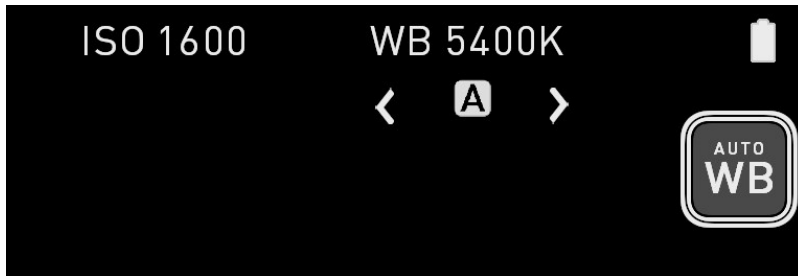
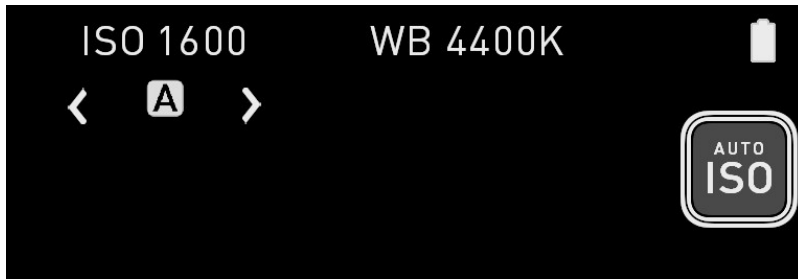

### **Access the Z CAM Menu from the display of NINJA V**

Tapping on the Menu icon on the right side of the screen will bring up some icons that replicate the physical buttons on the top of the ZCAM. The operation of these buttons are the same as the physical buttons.



Tap on the Menu icon in this view to bring up the Z CAM menu on your NINJA V screen. This is the same menu that appears on the screen of the Z CAM when you press the physical Menu button on the Z CAM. Tap on the icons to navigate through the ZCAM menu system and adjust settings, the same way you would when using the physical buttons on the ZCAM. Tap on the Menu icon again to hide the menu, and tap on the Return arrow icon on the right side of the screen to return to the previous screen.

F5.6 1/50 ISO1600

ND Clear 5300K

40°C   12.5V



Record



Video



Audio



Exposure



WB



Focus



Image



Connect



System

MENU



OK



L:   
M: 

00h00m 4K

24

PROXY

ProRes 422 HQ

HLG

# Camera Output

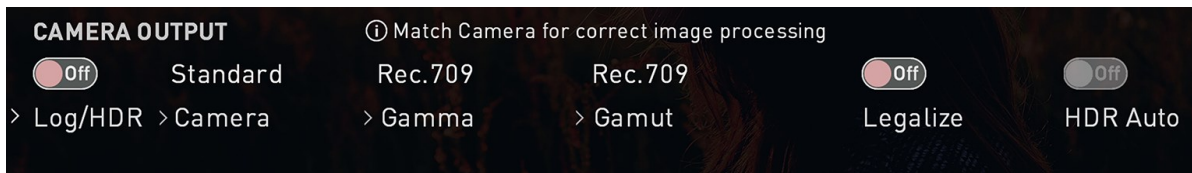

Choose to use Log/HDR, camera type, Gamma, Gamut or enable HDMI HDR auto if required. Your NINJA V will recognise most cameras when correctly attached via a compatible HDMI cable.



*For the best image processing results it is essential to match the NINJA V settings to the camera/input settings.*

## Log/HDR

Turn on to enable HDR image processing inside the NINJA V. Bring the control of post into your shoot - record, preview and review using HDR.

## Camera

Tap to scroll through to the manufacturer of the camera providing the input. Sony, Fujifilm, Canon, Panasonic, ARRI, RED and JVC.

## Gamma

For each manufacturer there may be a number of different Log curves available and you can scroll through to the correct selection by tapping the Gamma icon.

## Gamut

Select the Color Gamut of the input. This is not applicable to all cameras but again ensure that this matches the input of the camera to ensure accurate monitoring.

## Legalize

The legalize function allows you to convert a full range video signal into a legal range signal to suit legal range NLE editing workflows. This setting is designed for use with inputs in SDR or REC.709 that are set to or are fixed in FULL range, but recording or monitoring is needed in 'legal range'. The terminology used by manufacturers when referring to levels can vary, but all refer to the range of values contained within an image file:

Terms	8-bit values	10-bit values
Full / Data / Extended	0-255	0-1023
Legal / Video / Limited	16-235	64-940

If you are working in SDR/Rec709 and have a full range video signal coming in, it is best practice to turn the Legalize function ON, on your NINJA V. For Log inputs, the conversion to LEGAL range should NOT be applied. Log outputs from the cameras utilize FULL range signals in order to gain the maximum level of data and preserve dynamic range. The majority of Log base workflows are derived from Cineon, Kodak's original Cineon Film DI system. E.g. Sony, Canon and Panasonic all use FULL range levels.



*Do not apply the Legalize function to a LEGAL range signal as this will create an incorrect correct color pipeline. The result will create an image that is of lower contrast and look like Log but without the additional dynamic range of Log - as the camera output was already defined as a Rec.709 / BT.1886 gamma.*



*The legal range toggle is not available when using Atom HDR. Atom HDR is used for log workflows and when engaged the Legalize option will not appear.*



*The legalize option is not available for ProRes RAW video.*



## **HDR Auto**

HDR is detected when there is a compatible input signal. It is important that this is OFF if the camera is not outputting HLG or PQ. It should not be used for regular Log.

### **About Log/HDR**

A better understanding of Log and HDR will enhance your workflow and ultimately allow you to capture maximum amount of detail during recording, and save you time in post production. To understand more about the importance of this function please refer to the "Understanding HDR and Log" on page 294 section.

# Cross Conversion

When an AtomX SDI Expansion module or ATOMOS CONNECT is attached to your NINJA V, you can cross convert signals between HDMI and SDI.

This means that where HDMI sources are connected to your NINJA V, an SDI signal can be output from both of the BNC connectors on your AtomX SDI Expansion Module. In this scenario, both BNC connectors on the module can be used for two simultaneous SDI outputs, which allows you to output the same signal to two monitors.



*The SDI connector on ATOMOS CONNECT is an Input only, so HDMI signals connected to your NINJA V cannot be output via SDI with an ATOMOS CONNECT.*

Where an SDI video signal is connected to your AtomX SDI Expansion module or ATOMOS CONNECT, you can output an HDMI signal over the HDMI Out connector on your NINJA V.

Whilst converting the signals listed above, you can use the Output Options in the Output menu to downscale and crop the signals. The HDR section provides options for outputting HDR versions of the signals after cross conversion. For more information refer to the "Output Menu" on page 107 section.

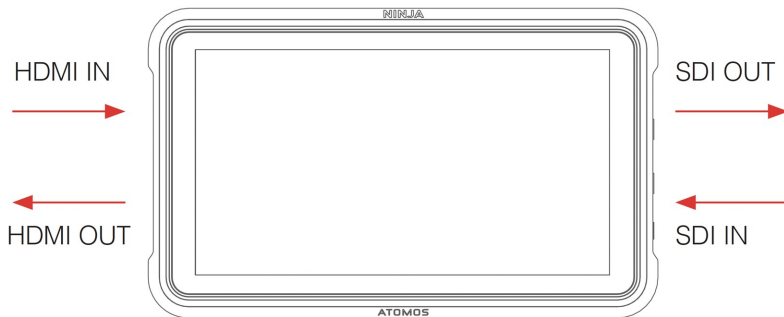

*To use the cross conversion feature, firmware version 10.6 or later needs to be installed on your NINJA V. Once you have installed this firmware, cross conversion will happen automatically and does not need to be enabled.*



*Cross conversion of SDI RAW video inputs is possible, once your NINJA V has been activated for RAW at [my.atomos.com](http://my.atomos.com). For more information refer to the "SDI RAW" on page 117 section.*

# Output Menu

This menu displays the active video format being output over HDMI, or SDI when the AtomX SDI module is attached. A 4K to HD down conversion can be applied to the output, which allows you to send a 4K input signal to a HD device. When working in HDR a signal will be output with the HDR flag to activate the correct settings on a compatible HDR display. This can be useful if you wish to monitor log footage in the studio.



## VIDEO OUT

This section displays the resolution of the Input. When processing options are applied below it will be adjusted accordingly.

## HDMI Output

Displays the resolution and frame rate of the HDMI Output from your NINJA V. When you have an AtomX SDI Module connected, the resolution and frame rate of the SDI Output will be displayed. For more information refer to the "Output via AtomX SDI Expansion Module" on page 110 section.

## **OUTPUT OPTIONS**

### **4K to 2K Output**

Allows you to scale 4K or UHD inputs for output. This will scale 4K to 2K and UHD will be scaled to HD 1080p.

### **DCI Crop**

When enabled, this setting trims the 17:9 DCI input to 16:9 converting the signal to UHD. When 4K to 2K Output is On, the output will down scale to HD.

### **HDMI timecode**

Allows for the embedded timecode or in unit generated timecode to be looped out. The option is present to allow you to turn the timecode as this can disrupt some consumer equipment that is not intended to receive embedded timecode. Tap to toggle between on/off.

### **SDI Compatibility Mode**

This option will appear when you have an AtomX SDI Module connected. For more information refer to the "Output via AtomX SDI Expansion Module" on page 110 section.

## **HDR**

Here you are able to set a conversion from your LOG input to a HDR display standard such as HLG or PQ. You can also define the output color gamut from your camera's gamut to a display standard for BT2020, DCI-P3 or Rec709.

### **HDR Out**

Enable or disable HDR on the output.

### **HDR Type**

Allows you to select the HDR type to output. Tap to cycle through PQ, HLG and Dolby Vision Tunnels.

**Gamut**

Allows you to select the Gamut of the signal that is output. Tap to cycle through Rec.709, BT.2020 and DCI-P3.

**LUT Out**

Allows you to loop out LUTs that are applied to your image, so that they are also applied to the Output signal.

# Output via AtomX SDI Expansion Module



## SDI Output

In the VIDEO OUT section of the Output menu page, the SDI module will automatically detect the resolution and frame rate of the SDI input when connected. The NINJA V detects the active input Channel Source and configures the other connector as an Output.

## SDI 3G Type

Allows you to specify the 'SDI 3G Type' for compatibility with equipment that expects a specific type of 3G-SDI video. Tap to cycle through the options:

- Level A,
- Level B or
- Auto.



*You can only output SDI when the INPUT is in 'SINGLE' or 'AUTO SELECT' mode.*

## **SDI Compatibility Mode**

Some video devices use a slightly different version of the 12G standard, which can cause issues with their ability to detect a video signal that is output from an ATOMOS device. Enabling SDI Compatibility Mode will cause your NINJA V to send out a video signal in the format that these devices expect. Tap the switch to toggle between On and Off.



# Record Menu



## Space Remaining

Indicates the expected recording time remaining on the inserted media at the current settings. Changing your recording settings may extend or decrease your available recording times.

## Pre-Roll (On/Off)

Whilst enabled, the input is constantly being recorded, with approximately the last 8 seconds in HD and 2-3 seconds in 4K being cached into memory. The frame rate and codec selected will determine the number of seconds being cached for Pre-Roll. Using a lower bit rate codec setting and shooting at a lower frame rate will increase the length of Pre-Roll.

When the record button is pressed or trigger is sent, the buffered Pre-Roll data in memory will be written out to the start of the recording. This means if you are a few seconds slow hitting the record button when something interesting happens you will still capture the shot.

With this option turned on you will see a red Pre-Roll icon flash in the top left hand corner of the display.



A white circular arrow will also appear around the record button.



*With Pre-Roll mode activated the Recorder is constantly caching frames internally to the unit and as such any feature that can not be changed whilst recording is disabled. This includes audio channel select, 3D LUT record, codec, disk options etc.*

## CODEC (Recording Format)

### Codec Format

To select a codec tap on the currently displayed codec to toggle between the options:

- Apple ProRes®,
- Apple ProRes RAW,
- Avid DNxHD® and
- H.265 (HEVC)

After selecting a codec, you will be prompted to tap Confirm to switch to that codec.



*If you select an optional codec like Avid DNx, ProRes RAW or H.265, you will be prompted to activate the codec at [my.atomos.com](http://my.atomos.com) as these codecs must be activated before use.*

## **Compression**

Tapping on this setting allows you to toggle the compression for the currently selected codec.

### **Apple ProRes**

Apple ProRes is built in to the NINJA V and offers three levels of compression (HQ, 422 & LT).

### **Avid DNx**

Avid DNx requires free activation via [my.atomos.com](http://my.atomos.com) and includes DNxHD with four levels of compression (220x, 220, 145, 36) and DNxHR for 4K/UHD inputs with four levels of compression (HQX, HQ, SQ and LB). DNxHD 220x/DNxHR HQX are 10-bit, whilst all others variants are 8-bit and DNxHD36 is a proxy codec.

### **Apple ProRes RAW**

Apple ProRes RAW also requires free activation via [my.atomos.com](http://my.atomos.com) and includes two compression options: ProRes RAW and ProRes RAW HQ. Compression artifacts are very unlikely with ProRes RAW, and extremely unlikely with ProRes RAW HQ.

### **H.265 (HEVC)**

H.265 (HEVC) is an optional codec that requires paid activation via [my.atomos.com](http://my.atomos.com) and provides three compression options HQ, MQ and LQ (High Quality, Medium Quality and Low Quality). For more information on using H.265 (HEVC) refer to the "H.265 (HEVC)" on page 122 section.

## **Record Format**

Displays the resolution and frame rate that is being recorded to your media.

## **Record Bit Depth**

When the H.265 codec is selected, an additional Record Bit Depth setting will be available on the Record page. Tap to cycle through the options which include 8-bit 4:2:0, 8-bit 4:2:2 and 10-bit 4:2:2.

## **PULLDOWN**

### **Pulldown Format**

Tap to cycle through pulldown formats. For more information refer to "Pulldown" on page 119

## RAW over HDMI

When connected to a supported camera via HDMI, you will be able to record RAW data over HDMI.

When RAW over HDMI is enabled on a connected camera, your NINJA V will automatically detect the RAW signal and prompt you to select ProRes RAW as the recording codec.



*Refer to the documentation for your camera on how to enable RAW over HDMI from the camera.*

# SDI RAW

You can add the SDI RAW feature to your NINJA V by purchasing the optional SDI RAW upgrade at [my.atomos.com](http://my.atomos.com).

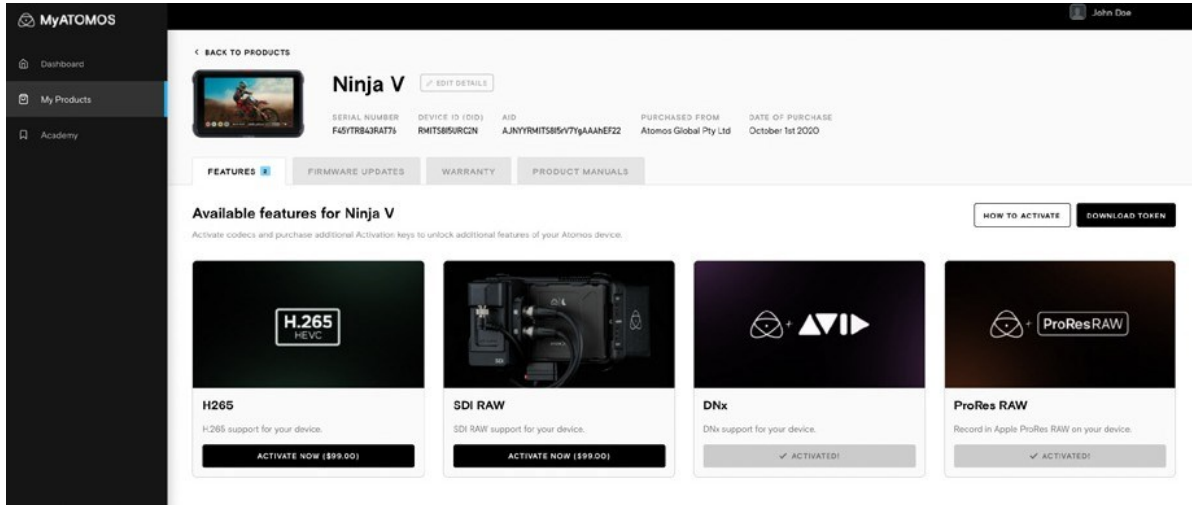

After activating the feature on your NINJA V, you can use the AtomX SDI Expansion module or ATOMOS CONNECT to record RAW over SDI from compatible cameras. Refer to the "Activation Menu" on page 224 section for more information on the activation process.



*When RAW over SDI is enabled on a connected camera, your NINJA V will automatically detect the RAW signal and prompt you to select ProRes RAW as the recording codec.*



*To use the ATOMOS CONNECT with your NINJA V, ensure you have AtomOS firmware version 10.8 installed. Visit [atomos.com/support](http://atomos.com/support) to download firmware for your device.*



*To use the AtomX SDI Module for SDI RAW, firmware version 10.6 or later needs to be installed on your NINJA V.*

## Sony Metadata Crop



To help with your video editing workflow, you can crop the RAW video captured from certain cameras like the Sony Alpha A7sIII, Sony Alpha 1 and Sony FX3 when recording ProRes RAW.

So for example, when recording 4.2K ProRes RAW video on the A7sIII the resolution is 4264 x 2408. Using the metadata crop feature will allow you to record the signal as 4240 x 2385, which has an aspect ratio of 16:9. This means that you can use the 4.2K footage in a 16:9 timeline in your NLE without having to be concerned whether the scaling of the image is correct.

Sony Metadata Crop will appear in the Record menu, when you have an HDMI RAW video signal that supports this feature and ProRes RAW is selected as the recording codec.

# Pulldown



## Pulldown Format

The record menu allows you to apply pulldown removal if recording from a source that applies pulldown to the output signal. Tap Pulldown Format to cycle between the options.



*For 3:2 Pulldown removal, movement in the frame may be required to accurately lock signal, simply wave your hand in front of the camera to achieve lock.*

## What is Pulldown?

Many professional and consumer cameras available today do not send true 1080p24, 1080p23.98, 1080p25, 1080p29.97 or 1080p30 signals to their HDMI outputs. Instead they send 1080i59.94 in NTSC regions (e.g. USA, Japan), and 1080i50 in PAL regions



(e.g. Europe) In order to convert the signal from the internal recording format to 1080i5994 or 1080i50, they use a process called 3:2 or 2:2 pulldown.

Camera Setting	Pulldown	NINJA V Receives
1080p23.98	3:2	1080i59.94
1080p24	3:2	1080i60
1080p25	2:2	1080i50
1080p29.97	2:2	1080i59.94
1080p30	2:2	1080i60

You will of course want the NINJA V to record the actual frame rate such as 1080p23.98, not the 1080i59.94 to disk. In many cases, it is not possible for the NINJA V to detect when pulldown has been applied to the video, so you will have to set the correct mode of removal on the NINJA V to match the setup of your camera.

With some cameras, the NINJA V can detect and remove the pulldown automatically, in which case the mode you expect (e.g. 1080p23.98) will display on the NINJA V and you will not have to do anything further.

If there is no input detected, then toggle the input by pressing the screen until you see the input you wish to record.



*ATOMOS is adding auto-detection support for more cameras, please check for firmware updates regularly at [www.atomos.com](http://www.atomos.com)*

## **1080p23.98 or 1080p24**

If you have set 1080p23.98 or 1080p24 in your camera and your NINJA V displays 1080i59.94 or 1080i60, then you can easily remove the pulldown by following these steps:

1. Select the Input Menu from the top Left and toggle the blue arrow underneath Record repeatedly until you see 1080p23.98 (or 1080p24) displayed. You may not get a green tick in this column immediately.
2. Your NINJA V needs to analyze the video for about 1 second, in order to detect the pulldown sequence and remove it.

3. If it is not automatically detected after 1 second, wave your hand from side to side in front of the lens, or wave the camera from side to side for a few seconds. The NINJA V will detect the pulldown cadence in the movement, and you will see a green tick along with the video displayed on the screen.



*3:2 pulldown detection is difficult, it is not impossible to detect on completely still video. This is why you should wave your hand in front of the lens.*



*If you lose the input detection – for example you unplug the HDMI cable or go to Playback mode, you will need to wave your hand or the camera again, when the signal is restored to the NINJA V.*



*Some cameras use a variant of pulldown removal, for example Panasonic Advanced pulldown. The NINJA V does NOT support this format, and it will not be detected.*



*Standard Panasonic pulldown is supported, ensure in the Panasonic camera settings that pulldown is not set to Advanced.*

## **1080p25, 1080p29.97 or 1080p30**

For these modes, access the Record Menu tab and simply press the Record Format options repeatedly until your 1080p desired format is displayed. There is no need to wave your hand or the camera, as 2:2 pulldown removal does not require moving video.



*Pulldown is only applicable to interlaced HD signals, not 4K*

## H.265 (HEVC)

H.265 (HEVC) is a highly efficient compressed codec that combines excellent image quality with a small file size, which makes it ideal for streaming and for the sharing of files. It is also well suited to situations where there is no time or budget for color grading, as you can 'bake in' Rec. 709 or a custom LUT to the file so that you can share files immediately at the end of a shoot.

H.265 is also an excellent option for recording high quality proxy files in an ARRI or RED SDI workflow, where RAW is being recorded internally on the camera. Your H.265 proxy recordings can also use the same file names as the RAW files, so that you can start editing with the proxy files immediately and then use the RAW files for the final color grade.

For information on using Red/Arri file names for your recordings, refer to the "File Menu" on page 210 section.

### **Activating the H.265 (HEVC) codec for your NINJA V**

You can add the H.265 (HEVC) codec to your NINJA V codec options by purchasing the optional upgrade through your [my.atomos.com](https://my.atomos.com) account. Once the upgrade is purchased and has been installed, you can select H.265 as a recording codec on the "Record Menu" on page 112 page. Refer to the "Activation Menu" on page 224 section for more information on the activation process and using [my.atomos.com](https://my.atomos.com).

## Wi-Fi Menu

When the Atomos CONNECT accessory is attached to your NINJA V and the device is in Connect Mode, you can access settings on the Wi-Fi menu tab. This menu provides settings for connecting your device to a Wi-Fi network, so that you can connect to Atomos Cloud Services. For more information on Connect Mode refer to the "Connect Menu" on page 132 section.



*An Atomos CONNECT must be attached to your NINJA V and the device must be in Connect mode before the Wi-Fi Menu page appears in the menu system.*

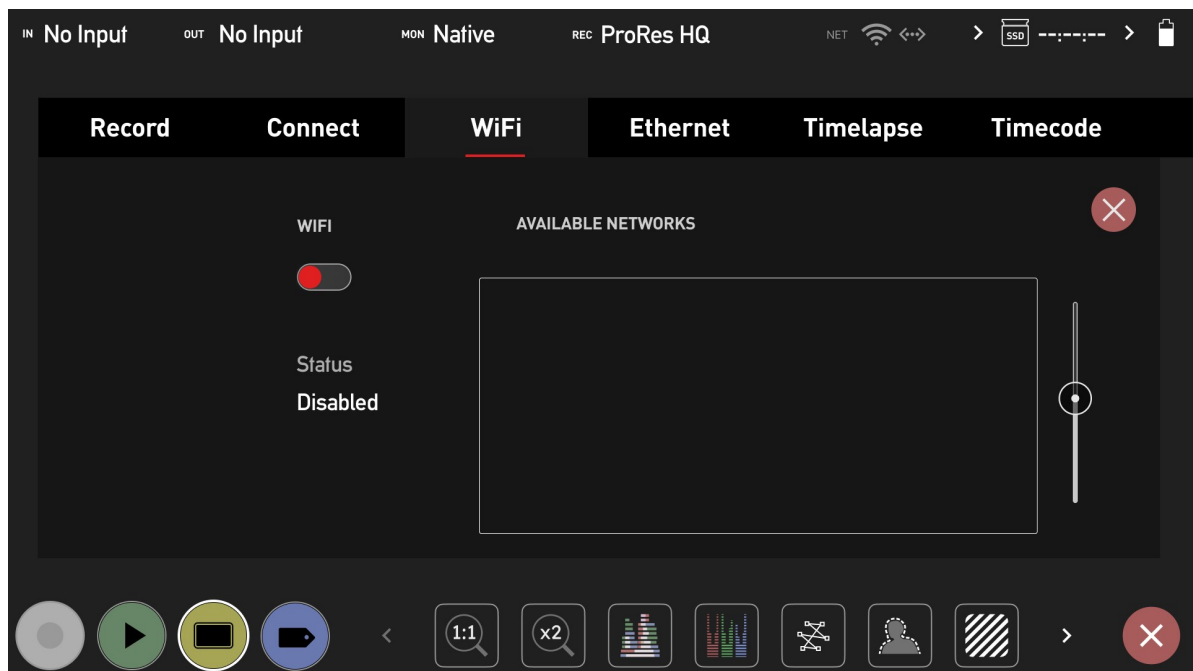

### How to connect to a Wi-Fi network:

1. Navigate to the Wi-Fi Menu page on your NINJA V.
2. Tap the toggle switch at Wi-Fi to enable Wi-Fi.



*The WiFi on/off status is saved on reboot*

3. The network name (SSID) of the available Wi-Fi networks will be displayed at Available Networks, along with the signal strength for each network and a padlock icon where a password is required to join the network. Tap and drag the list to scroll through the listed networks.

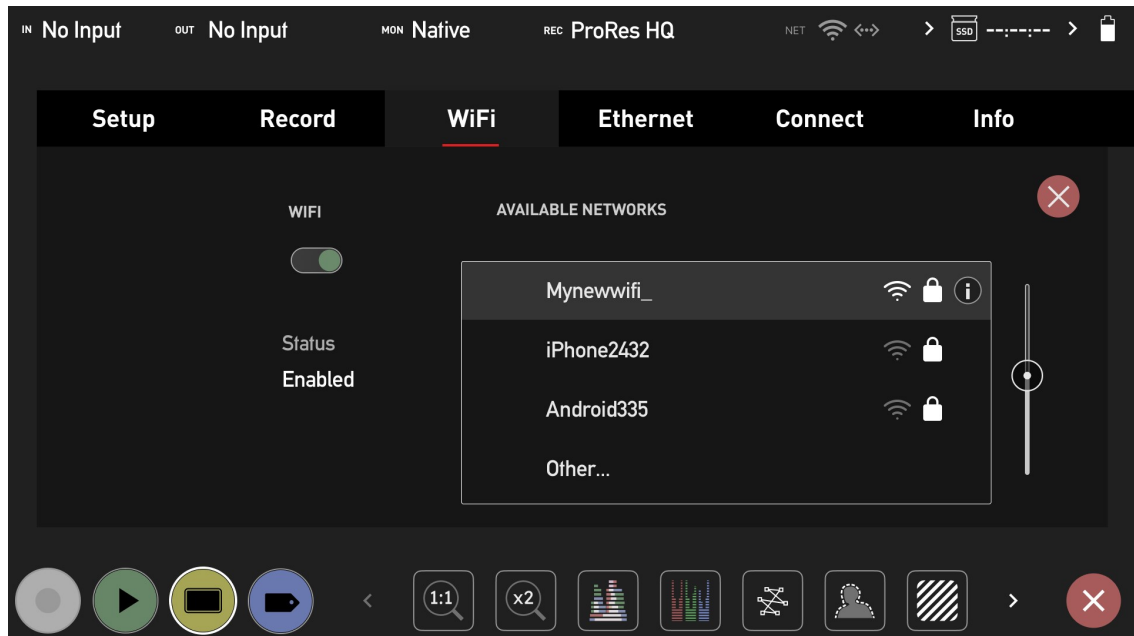

4. Tap on one of the network names to select it. A Join Network box will appear with the SSID, the security type and a field for the password. Tap on the password field to enter the password for the selected network.

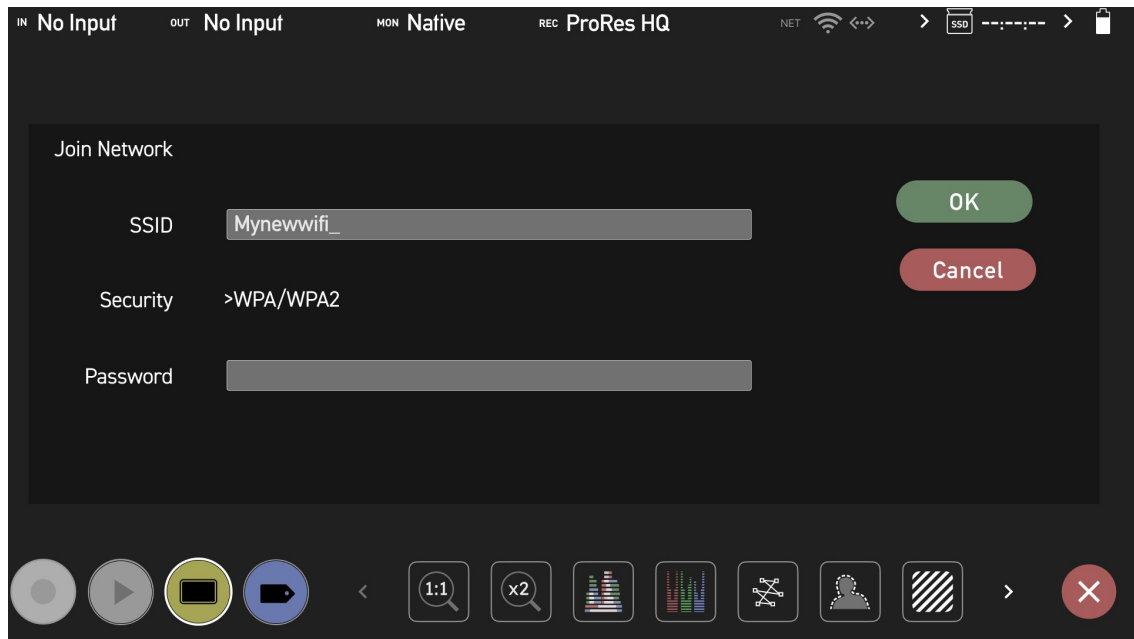

5. A keyboard will appear so that you can enter the password for the selected network. Enter the password for the network and tap on Ok. Tap on the Eye icon in the password field to toggle the visibility of the password on and off.

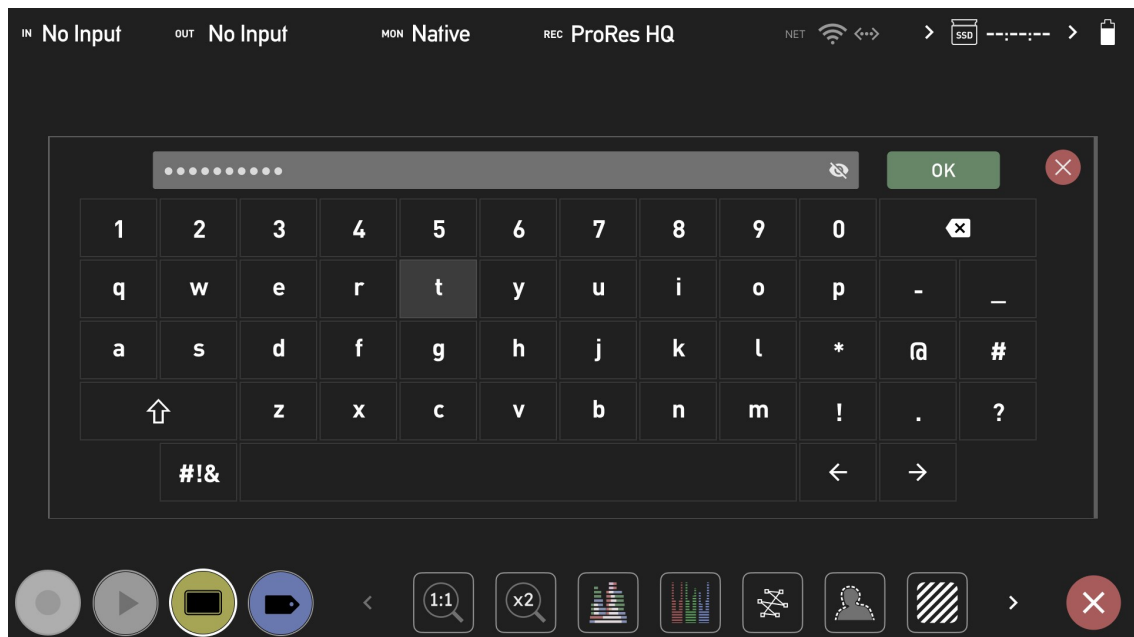

6. You will now be connected to the chosen Wi-Fi network, and a green tick will appear next to the network name. The MAC address will also be listed.

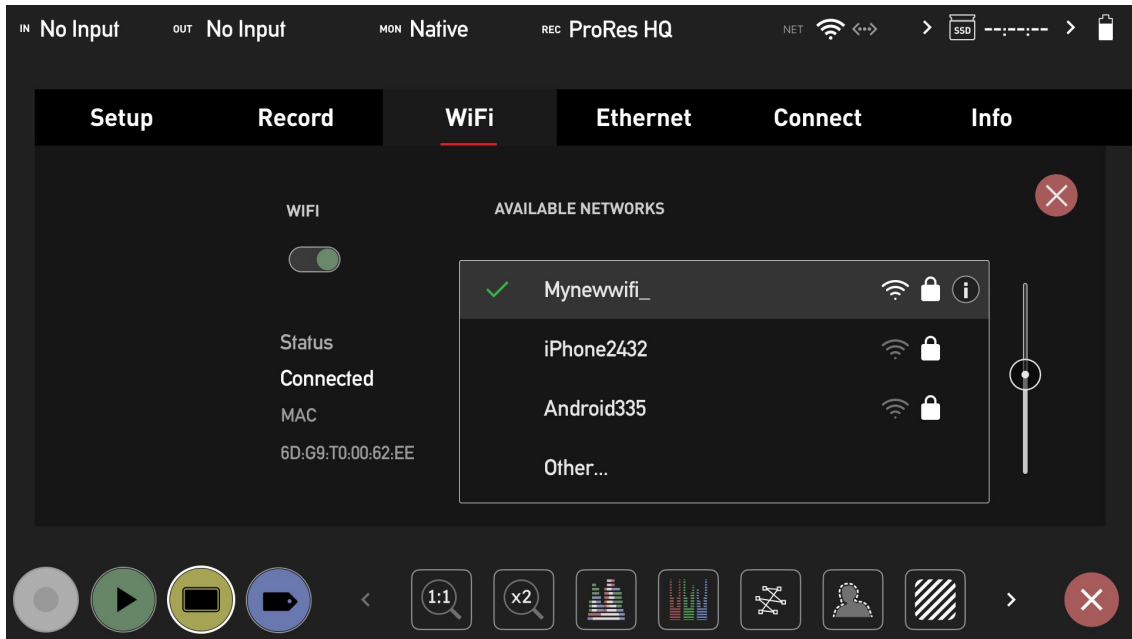

7. Now that you are connected to a network, the Connect Menu page will be updated with a green circle and the word 'Connected' at Network. Refer to the "Connect Menu" on page 132 section for information on connecting to the Atomos Cloud.

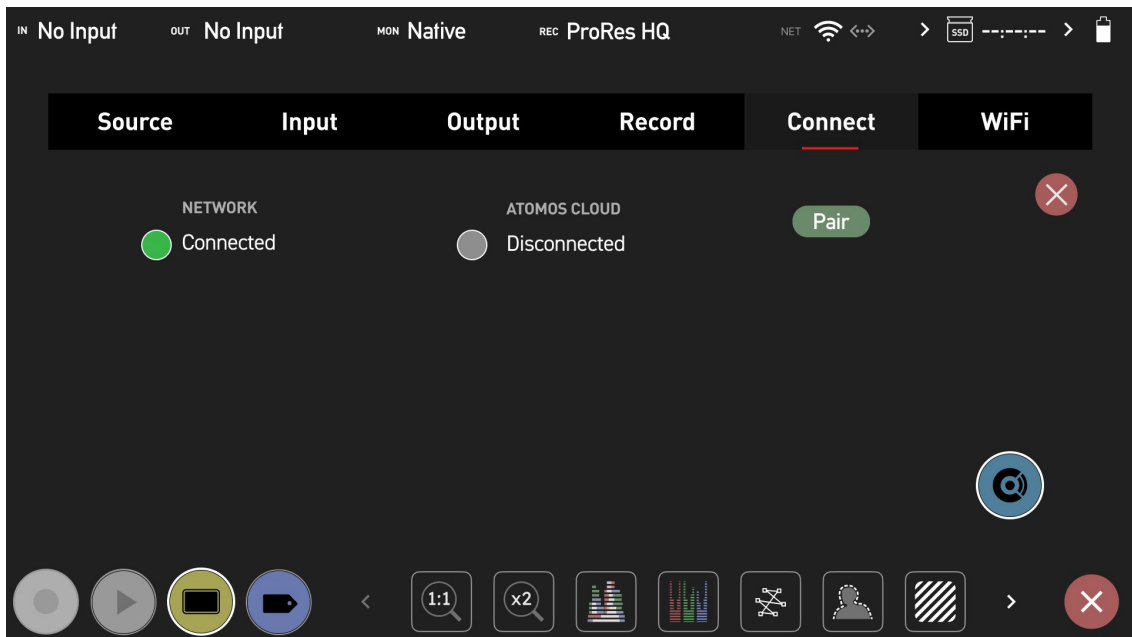



*It may take up to 10 seconds for Wi-Fi connections to be re-established when switching between record and playback mode.*



*When toggling Wi-Fi on and off, the On/Off toggle may not be immediately responsive. A dialogue message may suggest a system reboot to fix the issue.*



## Ethernet Menu

When the Atomos CONNECT is attached to your NINJA V and the device is in Connect Mode, the Ethernet menu tab will appear in the menu system. This menu provides settings for connecting your device to a network via Ethernet, so that you can connect to Atomos Cloud Services. For more information on Connect Mode refer to the "Connect Menu" on page 132 section.



*An Atomos CONNECT must be attached to your NINJA V and the device must be in Connect mode before the Ethernet Menu page appears in the menu system.*

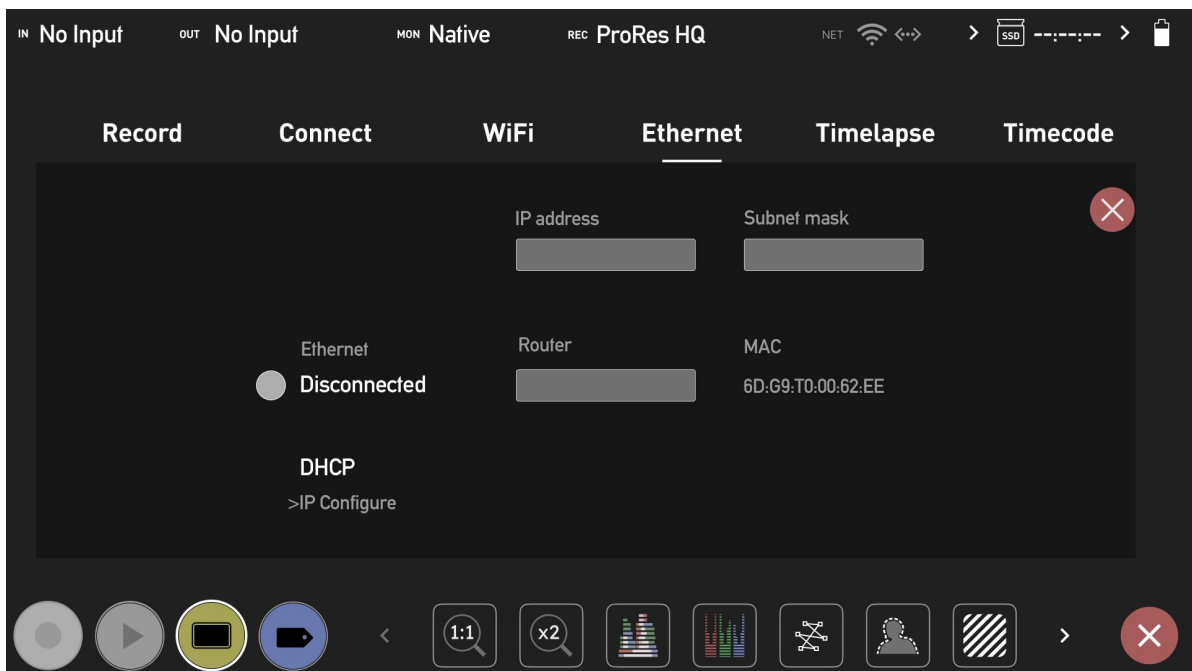

### How to connect to an Ethernet network

1. Plug an Ethernet cable from your network into the Ethernet connector on your Atomos CONNECT.
2. Navigate to the Ethernet Menu page on your NINJA V.
3. Tap on IP Configure to cycle through DHCP and Static. Select DHCP to configure the network connection details automatically. Your router will then automatically populate the DNS, IP address and Subnet Mask fields.



To use DHCP, your network needs to have DHCP enabled, so that it can automatically assign an IP address.

4. If you prefer to manually configure the network, select Static at IP Configure. Tap in one of the empty fields and a keyboard will appear so that you can enter the IP address, Subnet Mask and Router. Tap Confirm once you have finished entering these details.

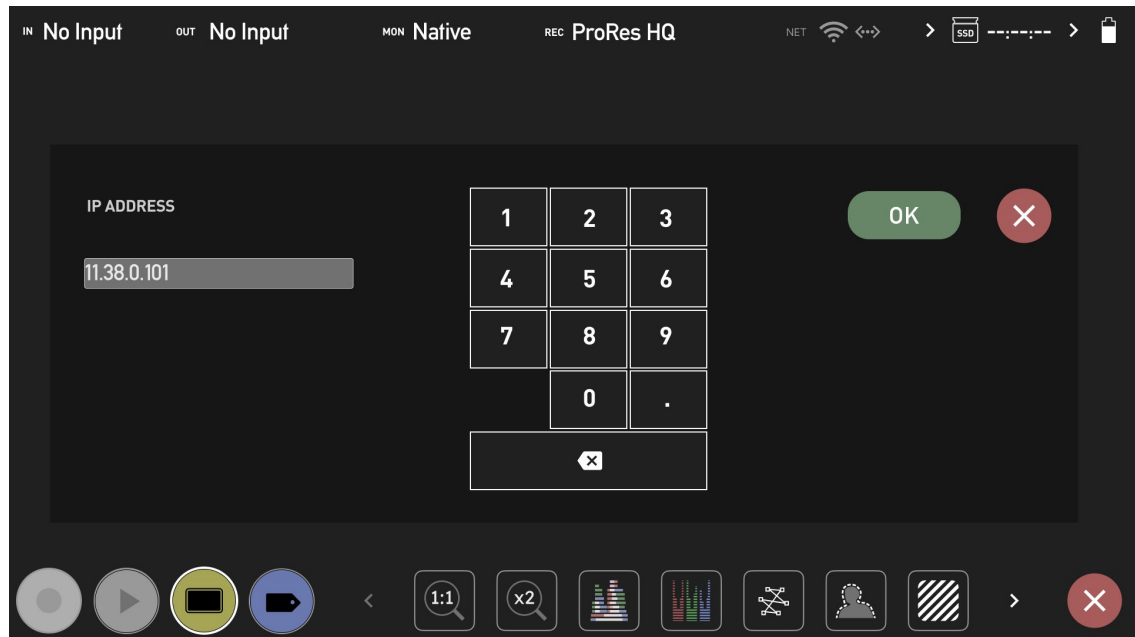

5. Once you have connected to an Ethernet network, a green circle and the word Connected will be displayed at Ethernet. The device MAC address will also be displayed.

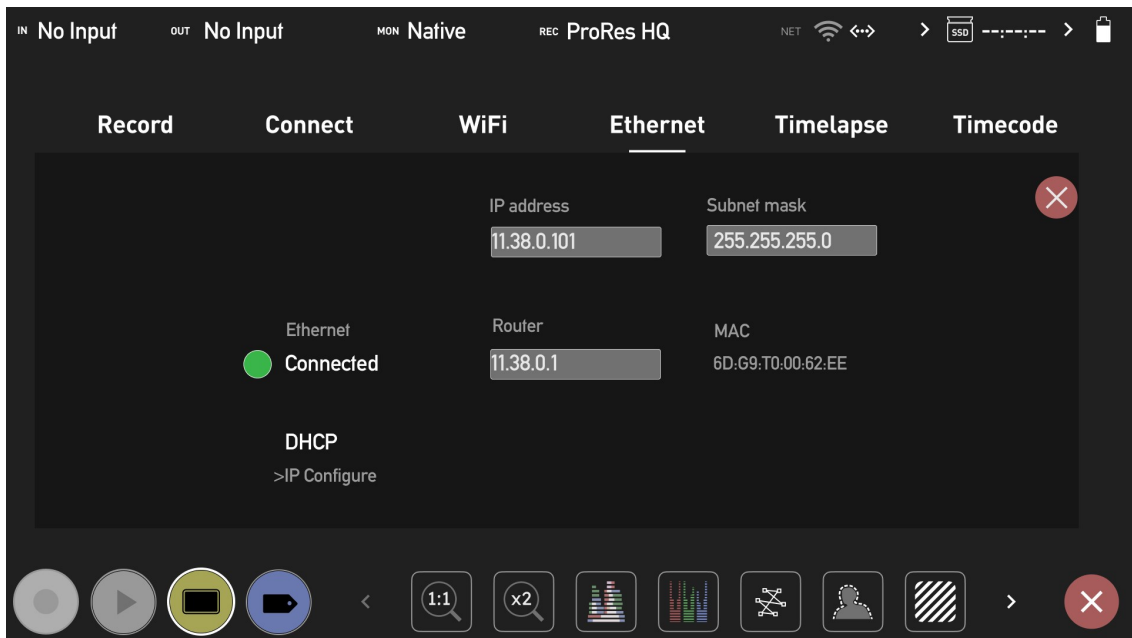

6. The Connect Menu page will be updated with a green circle and the word 'Connected' at Network. Refer to the "Connect Menu" on page 132 section for information on connecting to the Atomos Cloud.

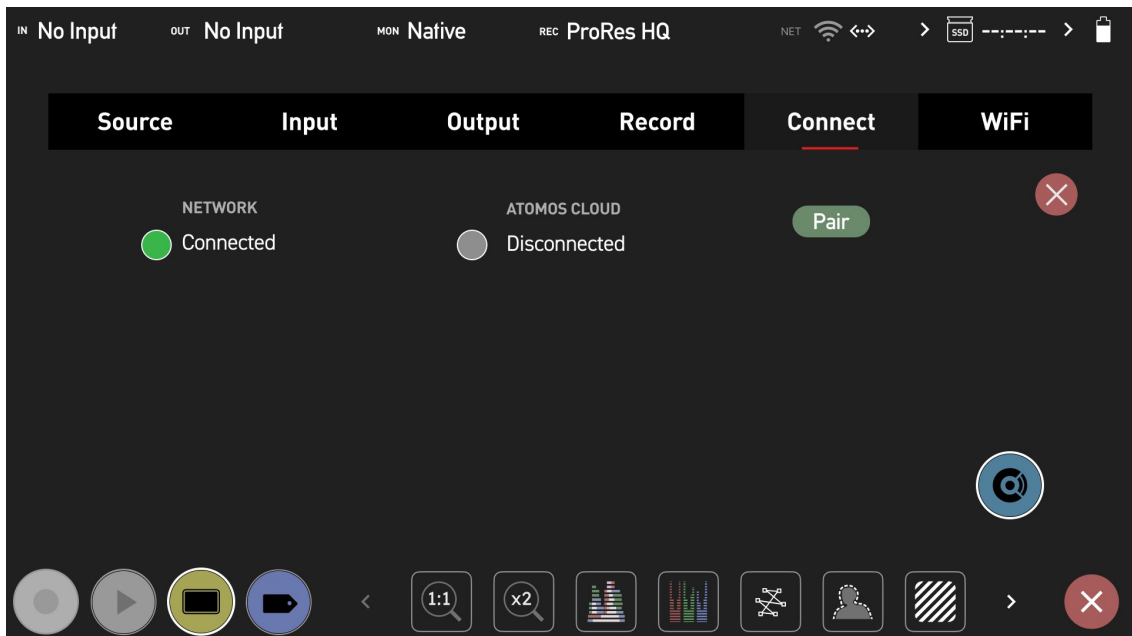



*It may take up to 10 seconds for Ethernet connections to be re-established when switching between record and playback mode.*

# Connect Menu

The Connect Menu allows you to pair your NINJA V with Atomos Cloud Studio. It also displays the details of services you have connected to.



*Networking and cloud features are only available when an Atomos CONNECT is attached to your NINJA V, and the device is in Connect Mode. Once in Connect mode, the WiFi and Network menu page tabs will be available, and you can pair your device with Atomos Cloud from the Connect Menu.*

## CONNECT MODE



The first time that you open the Connect Menu page with an Atomos CONNECT attached to your NINJA V, you will see the grey Connect icon on-screen. To use the network and cloud features of ATOMOS CONNECT, Connect mode must be enabled. Tap the Connect mode icon to enter Connect mode.



*The Connect mode button will only appear when an Atomos CONNECT is attached to your NINJA V.*



*This screen will also be displayed after performing a factory reset, or installing new AtomOS firmware.*

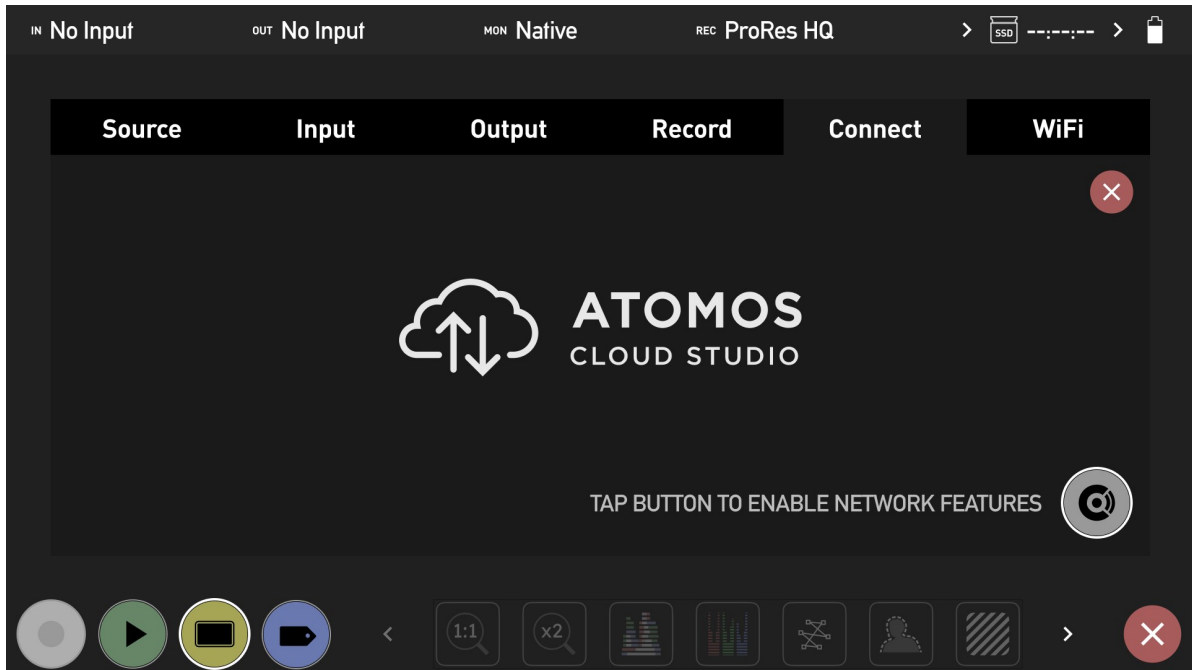

Once you are in Connect mode, the status of the network connection and the connection to Atomos Cloud are displayed. The Wi-Fi and Network Menu Page tabs will appear in the menu system and the Wi-Fi and Ethernet icons will appear in the information bar as well.

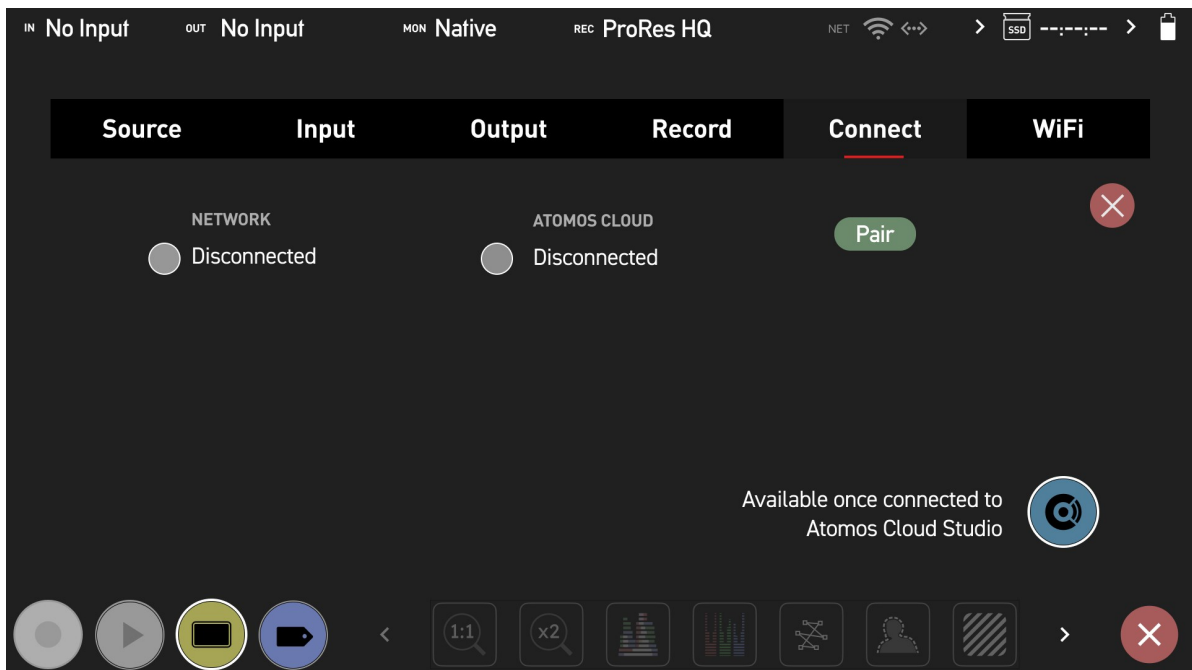



*Whilst in Connect mode, tapping the connect button will allow you to manually turn the connection to Atomos Cloud Studio on or off.*

## Connecting to the Atomos Cloud

Before connecting to the Atomos Cloud, your device must first be connected to a network. Refer to the "Wi-Fi Menu" on page 123 and "Ethernet Menu" on page 128 pages for further information on how to connect to a network. When connected to a Wi-Fi or Ethernet network, the corresponding icon will appear white in the information bar under Network. Once you have successfully connected to a network, you can follow the steps below to pair the device to the Atomos Cloud from the Connect Menu.

### How to Pair your device to the Atomos Cloud

1. Confirm that your device is connected to a network. The network connection status is displayed under Network as either Connected or Disconnected, with a green or grey circle to indicate the status visually.

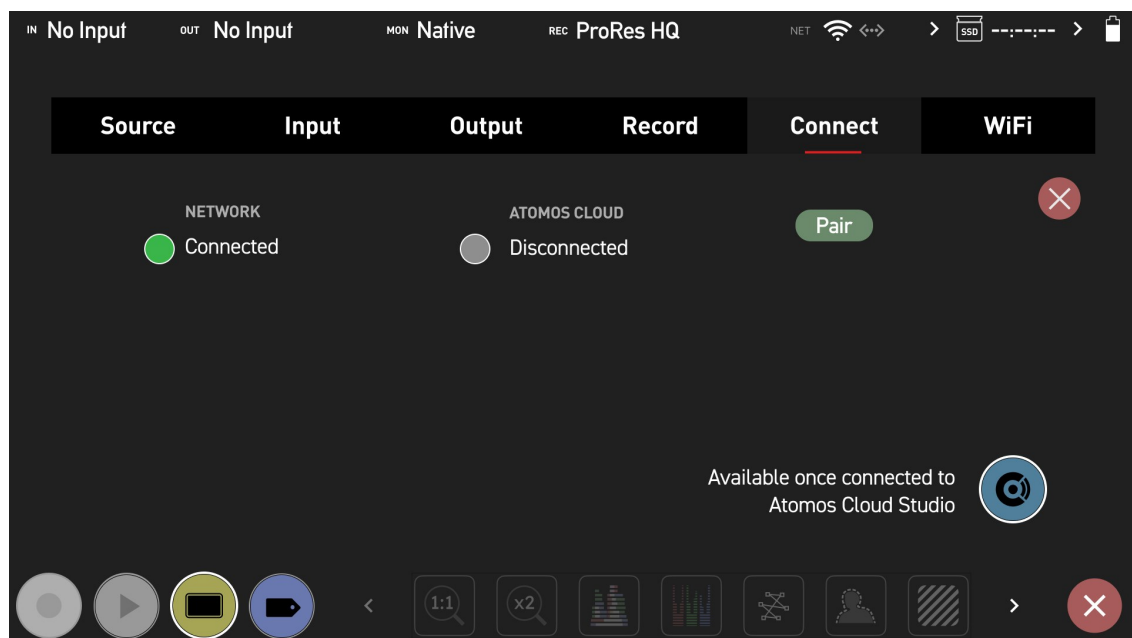

2. Tap on Pair.
3. The device communicates with Atomos Cloud Studio and is assigned a unique three-word combination, which is displayed on your NINJA V screen with a QR code.

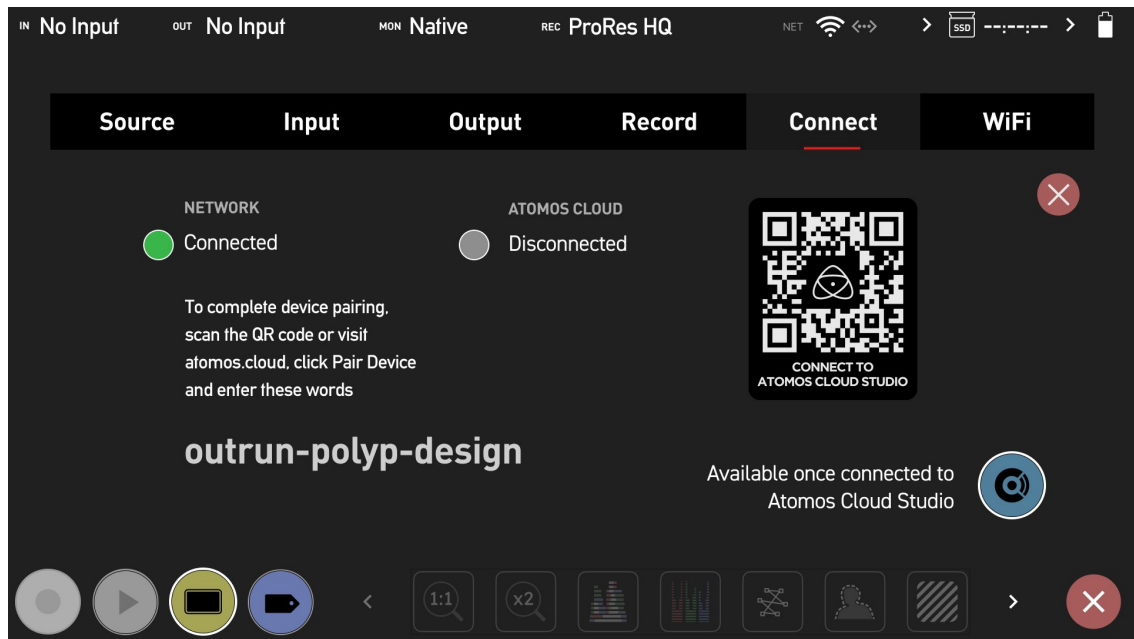

4. Scan the QR code to connect to Atomos Cloud Studio on your mobile device, or navigate to [atomos.cloud](https://atomos.cloud) on a desktop browser . Enter your details and tap/click Next to sign up for an Atomos Cloud Studio Account. Tap/click on Sign In if you already have an Atomos Cloud Studio Account, and follow the prompts to sign in.



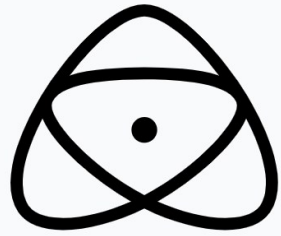

# ATOMOS

CLOUD STUDIO

Sign up for an ATOMOS Cloud Studio Account

Full Name

Region

Please choose the region closest to your location

Email

Repeat Email

**NEXT**

By signing up, you agree to our [Terms of Service](#)

Already have an account? [Sign In](#)

5. Follow the guidelines to create a suitable password.

Create a password  
Your password must be at least 6 characters long, contain  
1 special character, number and uppercase letter

Password

Repeat Password

**NEXT**

Already have an account? [Sign In](#)

6. Check your email inbox for an email from Atomos with a six digit verification code. It will be sent to the email address used to create your Atomos Cloud Studio Account. Make sure you check your Junk-mail folders as well. Enter the verification code on screen when prompted and tap/click Next.

Finish Creating Your Account  
An email has been sent to your address containing a  
code to finish setting up your account  
[Resend Email](#)

Confirmation Code

**NEXT**

Already have an account? [Sign In](#)

7. The main page will then open on the Devices tab. This screen displays the CONNECT devices that have been paired with your Atomos Cloud account. Tap/click on Pair Device in the center of the screen.

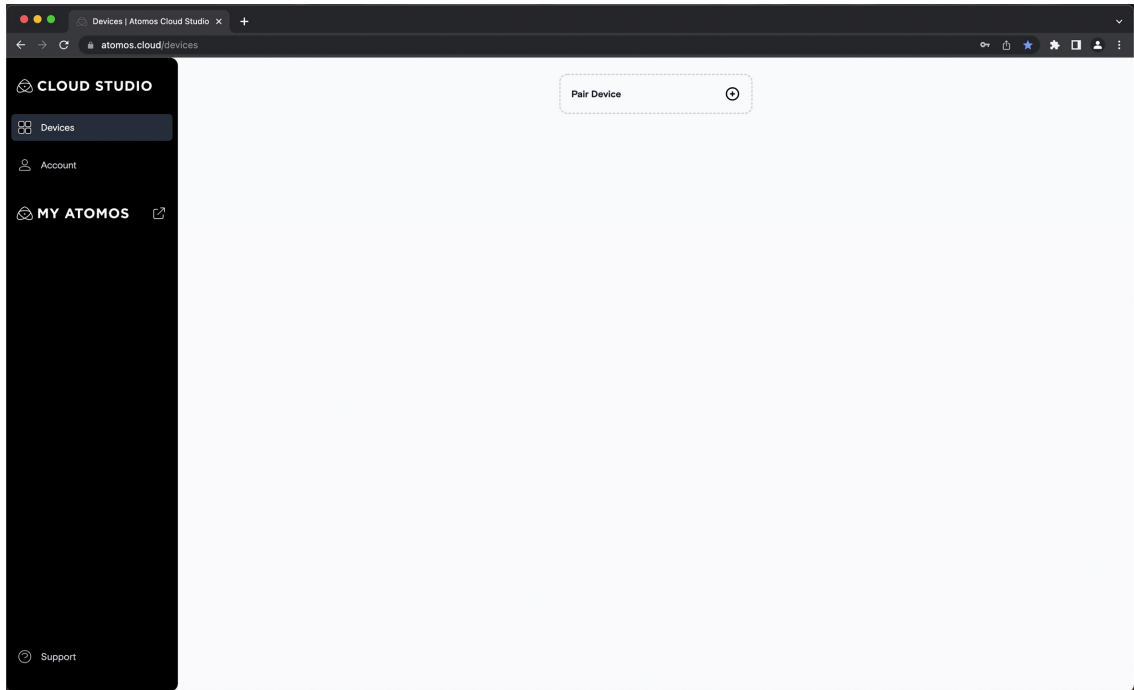

8. A window will appear with spaces to enter the three word code that was shown on your Atomos device. Enter the three words in the spaces provided and tap/click on Next.

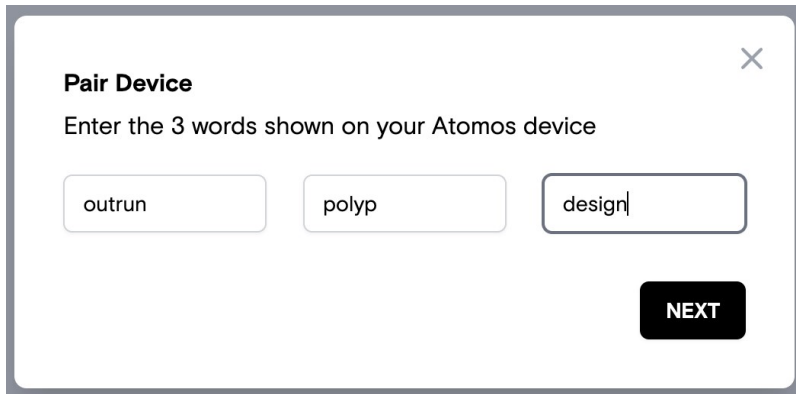

9. Give your device a nickname to help identify it.

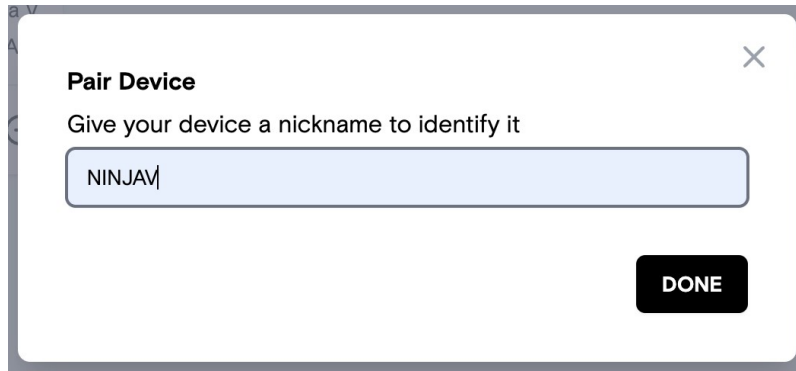

10. The device has now been paired with your Atomos Cloud account. The Devices tab will update to show an image of the device you paired and its details. The three word code is displayed on the image of the device and the device type appears at Device. When your device is connected to Atomos Cloud, a green circle will appear next to the device nickname at the top of the device box.



11. The Connect Menu page of your NINJA V will also update to display Connected at Atomos Cloud with a green circle to indicate the status visually. The name used to create an Atomos Cloud Account will be displayed at Account, and the current device

mode will be displayed at Device Mode. This will be either Frame.io C2C mode or Live Stream mode. Destination lists the name of the project selected as a destination.

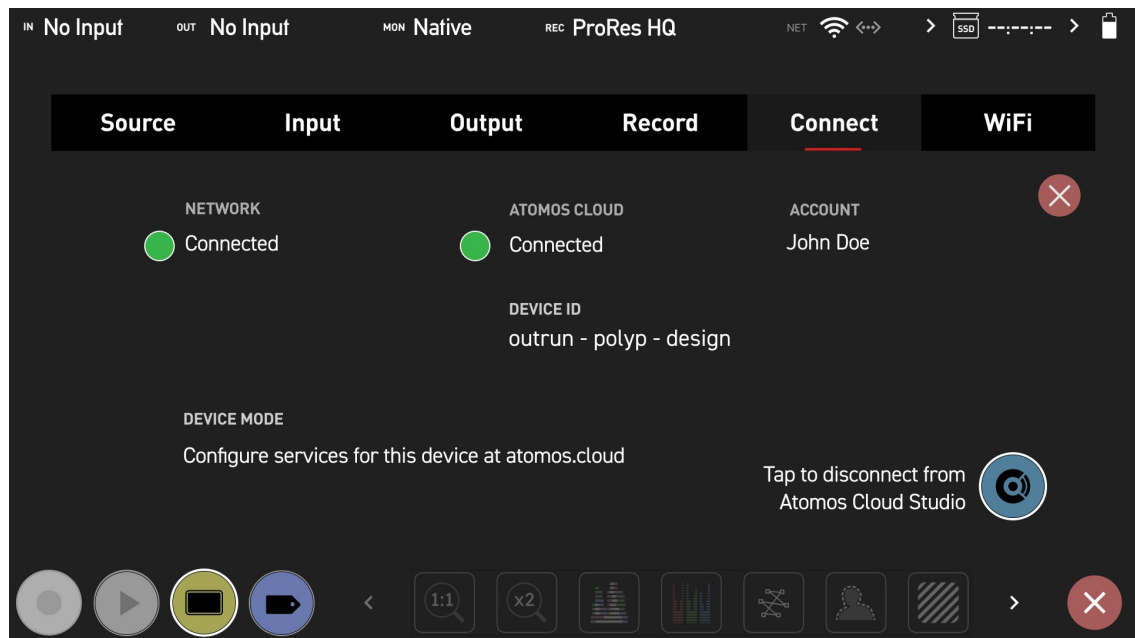

12. Next you will need to configure the services for this device at atomos.cloud. Tap on the + symbol next to Add Destination in the device box to add a destination.

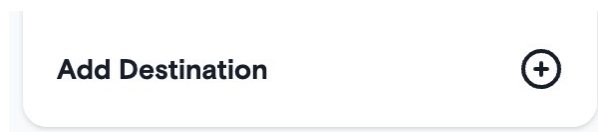

13. A new window opens displaying the destination options. Click to select a destination and you will be prompted to enter your credentials and other settings for that destination.

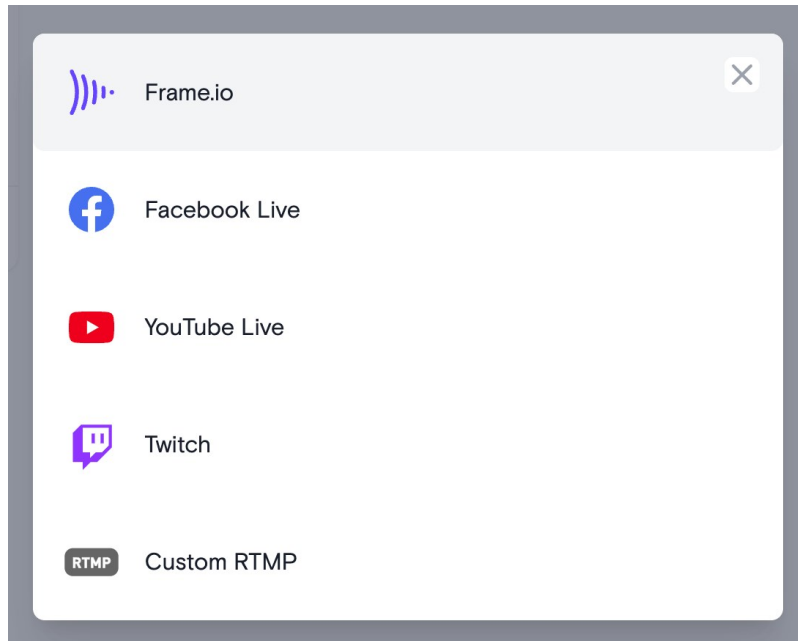

## Adjusting settings for paired devices

Tapping/clicking on the three dots in the upper right corner of the device image box displays options to change the nickname or unpair the device.

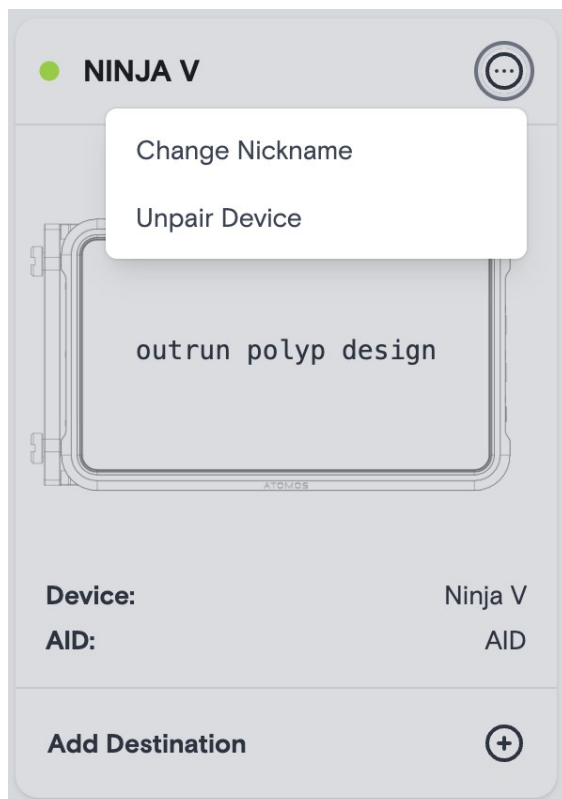

## Unpairing your device from the Atomos Cloud

If you decide that you would like to unpair a device from your Atomos Cloud Account, select Unpair Device from the drop-down menu. A dialog box will ask you to confirm your decision.



*Unpairing a device will also disconnect any associated services that you may have connected to.*



*Before performing a factory reset, ensure that you have unpaired your device from the cloud*

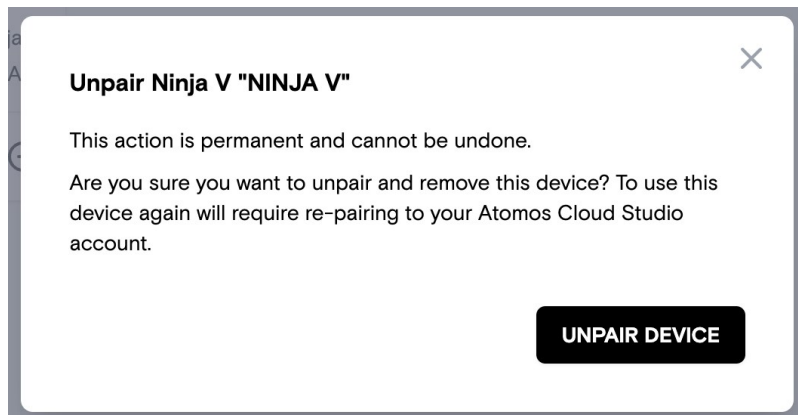

## Adjusting Settings

If you would like to make changes to your Atomos Cloud Account, tap/click on Account on the left side of the screen to open the Account tab. This page allows you to change your password, edit your profile details or sign out of the Atomos Cloud Studio Account.

---

Change Password

Edit Profile

---

Sign Out Account



# Connect Menu - Atomos Cloud Studio

ATOMOS Cloud Studio is a powerful collection of new cloud-based video production services, including ATOMOS Capture to Cloud and ATOMOS Stream. This allows anyone with a compatible camera or device to make use of these tools to share media and collaborate in real-time.

Create an Atomos Cloud Studio account at [cloud.atomos](https://cloud.atomos.com) to get started.

## ATOMOS Capture to Cloud

Cloud-based workflows are rapidly growing in popularity and have proven their efficiencies on thousands of productions. Atomos Capture to Cloud adds new dimensions to these systems by allowing any HDMI or SDI equipped camera or device to be connected to online services.

This provides a powerful, flexible, and immediate way to share content from devices or clips from a camera to remote team members. By removing the need to manually offload cards and wait for rushes to be reviewed, this workflow will continue to break down the traditional divisions between production and post, to bring teams closer together wherever they are.

## Frame.io Camera to Cloud (C2C)

Online review and collaboration platforms like Frame.io have become essential and have transformed the relationship between production and post by eliminating the delay between these stages. Frame.io Camera to Cloud is an ecosystem of **C2C Connected Devices** that connect Frame.io to the production set, by uploading video and audio from your camera on set to Frame.io between each take.

When it is paired with ATOMOS CONNECT, your NINJA V becomes a Frame.io C2C Connected Device, that connects directly into the Frame.io C2C ecosystem. This allows anyone with a compatible camera or device with HDMI or SDI to use Frame.io Camera to Cloud as well as the review and collaboration tools within Frame.io.

With Frame.io for Creative Cloud now included in the Creative Cloud subscription, even more filmmakers, streamers, and video content creators will have access to the powerful features of Frame.io.

The dual recording feature of the NINJA V creates matching "hero" Avid DNxHR/HD or Apple ProRes 422 and "proxy" 1080p HEVC (H.265) files, so that the proxies can be shared and securely backed-up even as it is being recorded.

## **ATOMOS Stream**

Allows you to live stream to popular platforms like YouTube, Facebook Live, LinkedIn Live, Microsoft Stream, Twitch and more. The integrated system supports a wide range of cameras that sets a new benchmark for flexibility and points of entry. Customers can choose to work with high-end digital cinema cameras and mirrorless, DSLR, USB cameras or even iOS devices.

ATOMOS Stream is designed to make sharing live video to popular online platforms easier, by making the process of configuring the stream more straightforward and more secure.

# Connect Menu - Capture to Cloud

ATOMOS Capture to Cloud provides a powerful, flexible, and immediate way to share clips from a camera or device to remote team members using services like Frame.io Camera to Cloud (C2C).

## Using Frame.io Camera to Cloud (C2C)

When it is paired with an ATOMOS CONNECT, your NINJA V can become a Frame.io C2C Connected Device that connects directly into the Frame.io Camera to Cloud ecosystem. This ecosystem connects Frame.io to the production set, by uploading video and audio from your camera on set to Frame.io between each take.

Selecting Frame.io as a destination in Atomos Cloud Studio allows you to use Frame.io Camera to Cloud to upload proxy files directly into your Frame.io project. Having the proxy files uploaded to Frame.io whilst you are recording them, means that an editor can access these files from anywhere in the world, and begin editing immediately. For more information on Frame.io Camera to Cloud, refer to <https://frame.io/c2c/> or watch the Frame.io Training Series at <https://frame.io/c2c-training/>

The dual record feature of the NINJA V, creates matching "hero" clips (at up to 4Kp30 ) in either Avid DNxHR/HD or Apple ProRes, and 'proxy' 1080p HEVC (H.265) files so that a clip can be shared and securely backed-up even as it's being recorded. Once the edit is completed in your NLE, you can easily relink to the high quality 'hero' files for final color grading, visual effects or other post-production steps.

## Setting up your Frame.io account

Before selecting Frame.io Camera to Cloud as a destination in Atomos Cloud Studio, you need to have a Frame.io account already set up. Visit <https://frame.io/> and follow the prompts to create a Frame.io account.

You also need to have created a project that you can select as a media destination, and ensure that in the settings for the project you have enabled **C2C Connections**. This allows your NINJA V to connect directly into the Frame.io C2C ecosystem and upload proxy files directly into your Frame.io project.

To enable C2C Connections, click the toggle switch at C2C Connections to ON when creating a new project from the web app, mobile web, or in the Frame.io iOS app.

### New Project ✕

---

 Anyone on your team can view this project Public

---

 C2C Connections   
Enable connections to upload media

 Enable Slack Notifications

---

Collaborator Permissions

Can Download Files

---

My Email Notifications

New Comment

New Media Uploads

---

You can also enable C2C Connections on an existing project by clicking on the three dots in the top right corner and selecting Project Settings.

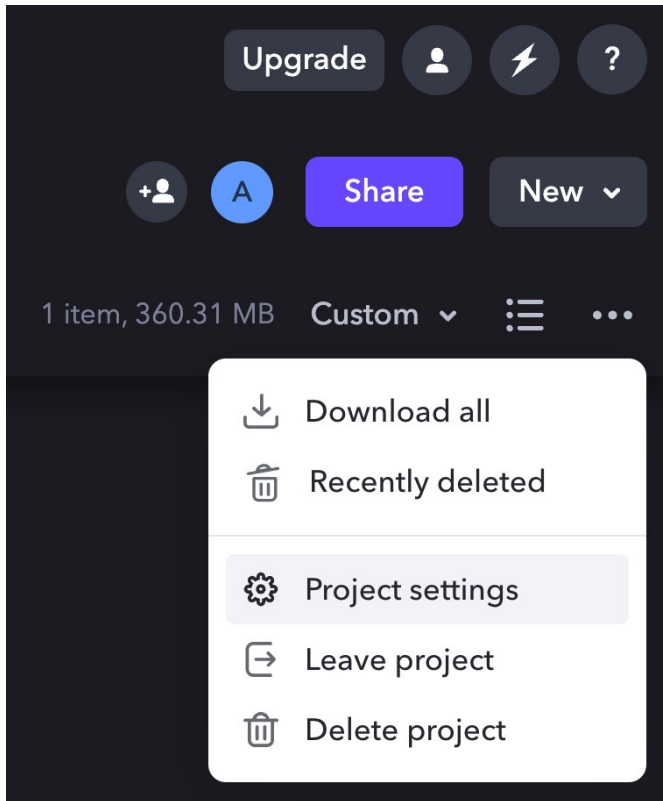

An Edit Project dialog box will open, where you can click to toggle the switch at C2C Connections to ON.

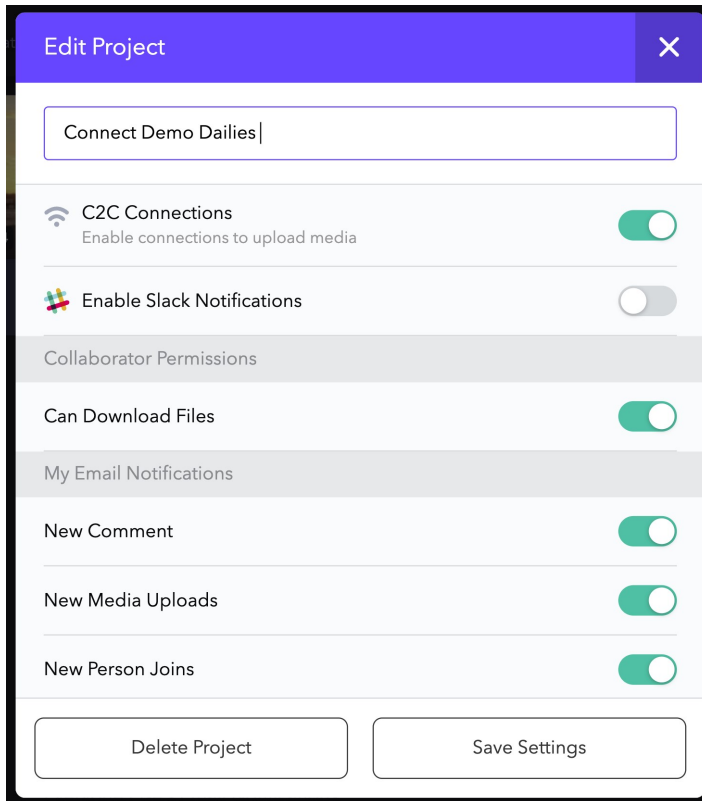

Once you have enabled C2C Connections for your project, you can follow the steps below to set Frame.io Camera to Cloud as a destination in your Atomos Cloud account.



*To select Frame.io – Camera to Cloud (C2C) as a destination in ATOMOS Cloud Studio, AtomOS 10.81.00 or later must be installed*



*Atomos devices cannot be paired from within Frame.io by using the 6 digit code method. Your Atomos device MUST be paired to Frame.io via ATOMOS Cloud Studio.*

### **Setting Frame.io Camera to Cloud as a destination in Atomos Cloud Studio**

1. Follow the steps in "Connect Menu" on page 132 to pair your device to the Atomos Cloud. Once paired, click on Add Destination in the device box.



2. Select Frame.io from the options.

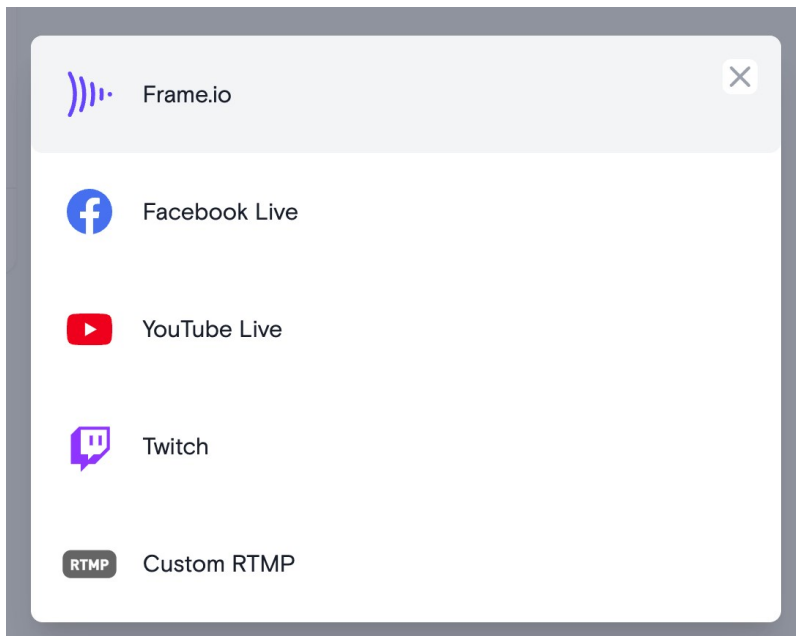

3. You will be prompted to log in to your Frame.io account.

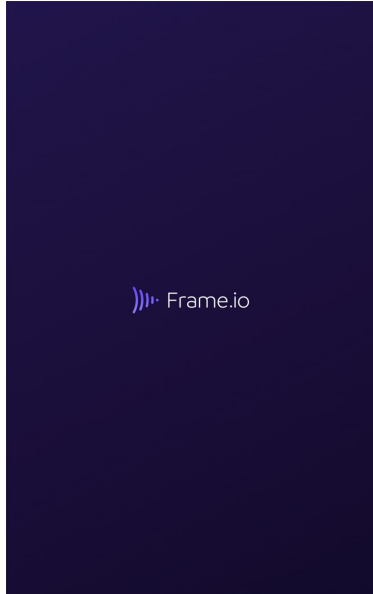
A white login form on a light background. At the top is the Frame.io logo. Below it, the text "Welcome" is centered, followed by "Enter your email to get started." Below this is a text input field labeled "Email" containing the text "john@johndoe.com". At the bottom is a blue button with the text "Let's go" in white.

4. You will then be asked to allow your Atomos Cloud account to connect with Camera to Cloud enabled projects in your Frame.io account. Click on Allow to proceed.

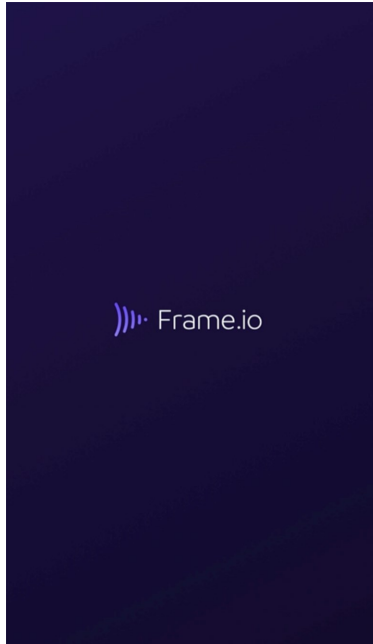
A white permission screen. At the top, there is a box with the letter "A" and an arrow pointing to the Frame.io logo. Below this, the text "Atomos Cloud would like to:" is centered. This is followed by three lines of permissions: "Access basic information about you.", "Create Assets in your account.", and "Access information when you are not actively using the app." Below these is a line of text: "Connect with Camera to Cloud enabled projects in your accounts." At the bottom are two buttons: a blue "Allow" button with a mouse cursor over it, and a white "Cancel" button with a grey border.

By clicking Allow, you allow this app and Frame.io to use your information in accordance with their respective terms of service and privacy policies. You can change App Permissions at any time.



5. You will then be returned to the Devices tab whilst your Atomos Cloud Studio account pairs with Frame.io. Once paired, you will be able to select a Frame.io project to be used as a media destination for your device. Your personal Frame.io projects will be displayed, along with any projects that you have been invited to work on. Click on a project to select it as the media destination and then click on Done.



*Your Frame.io account and project need to be already set up in Frame.io before you can select it. The project also needs to have the C2C Setting enabled.*



*The security settings associated with your Frame.io account will dictate the projects that you are permitted to select.*

**Choose a Frame.io project for NINJAV's media destination** ✕

Account

Atomos's Account

Project

John's Project

Connect Demo Dailies

**DONE**

6. Frame.io will now appear at the bottom of the device box with a toggle switch to enable/disable the Frame.io destination for this device. Click to toggle the switch to On.



*Toggling a destination On, will disable other destinations if they are enabled.*



*Only one destination can be selected at a time.*

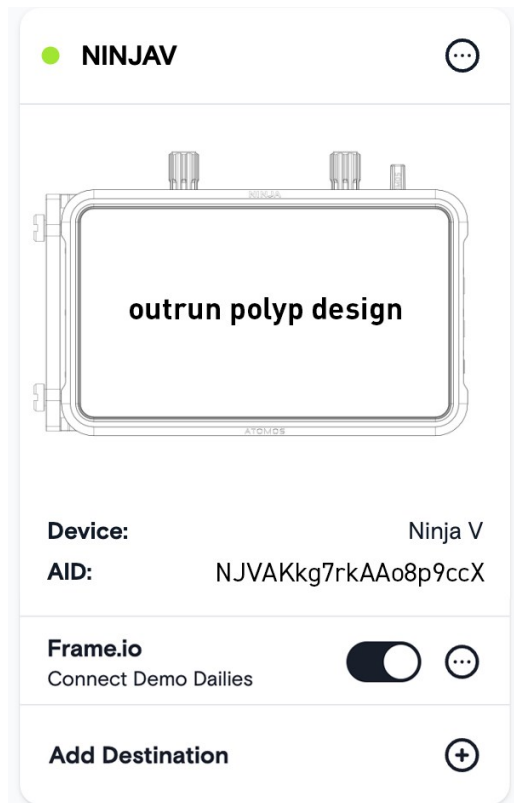

7. Log into your Frame.io account in a new browser window and navigate to the Frame.io project that you selected to be used as a media destination for your device.

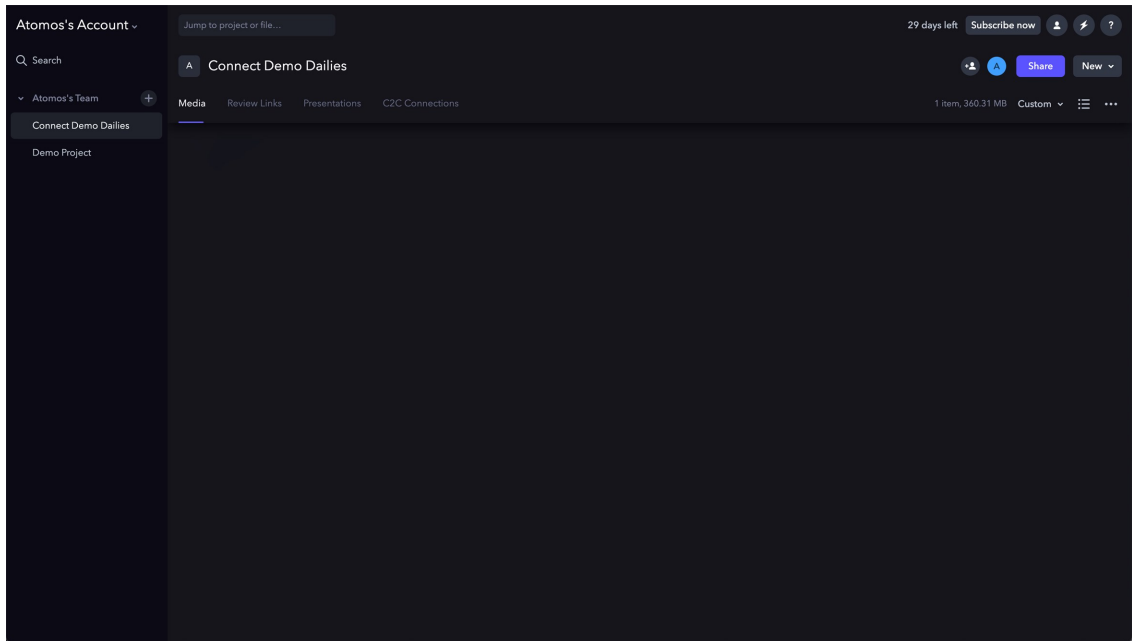

8. Click on the C2C Connections tab to view the Frame.io Camera to Cloud C2C Connections. These are hardware devices and apps that connect directly into the Frame.io C2C ecosystem. Atomos connected devices will appear here, and will have a green dot on a device when the device is currently connected to Frame.io.

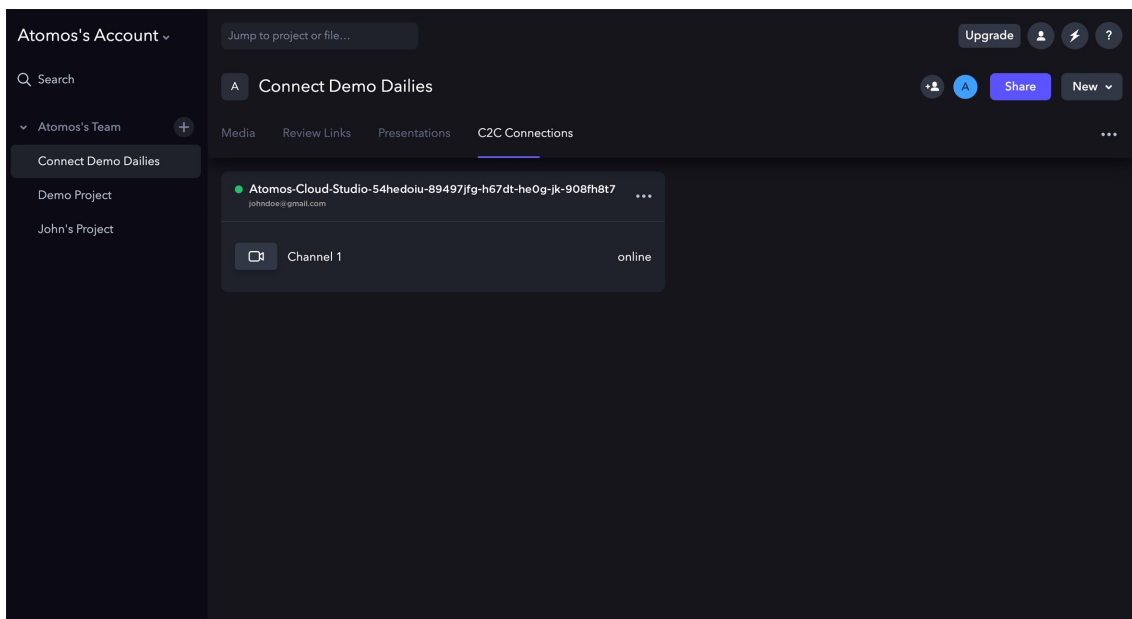

9. By default, the name of the device will be 'Atomos-Cloud' with an alpha numeric sequence. Clicking on the three dots on the right hand side of the connection box will display a menu that allows you to rename the connection. You may wish to use the same name that you used in Atomos Cloud Studio, so that the device has the same name on Frame.io. The other settings here allow you to pause, forget or set an expiration for the connection.

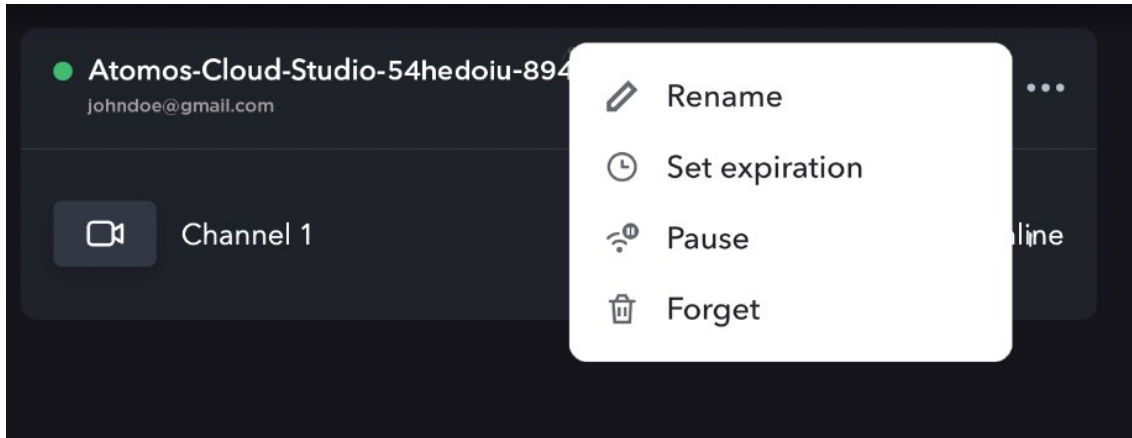

10. The Connect Menu page on your NINJA V will update to indicate that the Device Mode is Frame.io C2C. The selected Frame.io project will also appear at Destination.

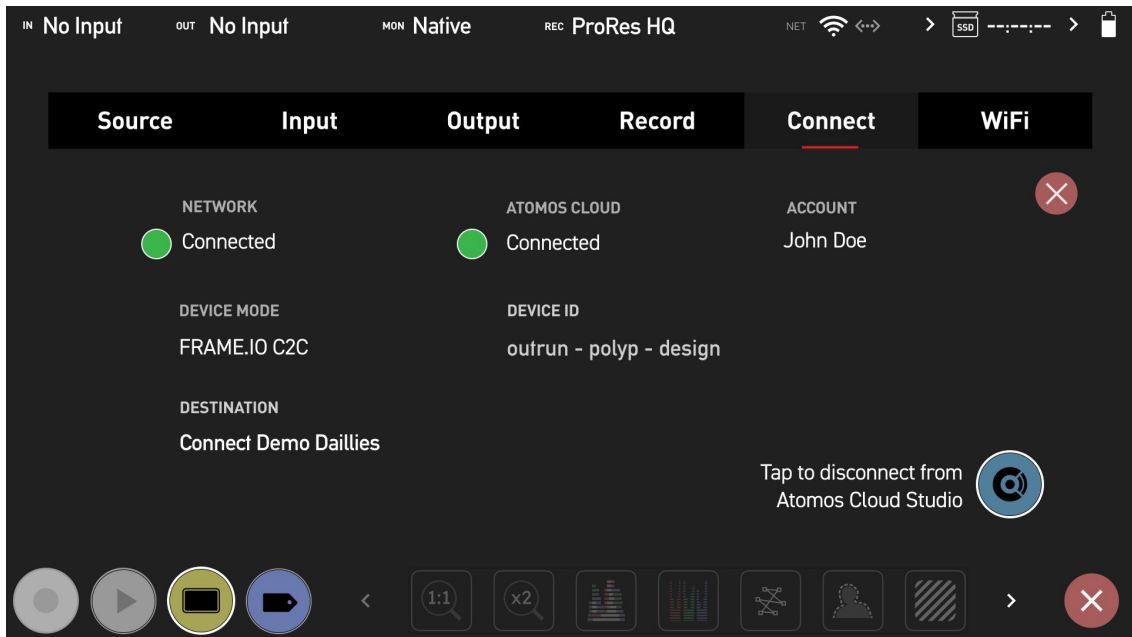

11. A green circle will also appear in the top left of your NINJA V display, to indicate that your device is currently connected to the cloud, and that the connection is idle. The text next to the icon will confirm the status of the connection and if there are any remaining files to be uploaded.

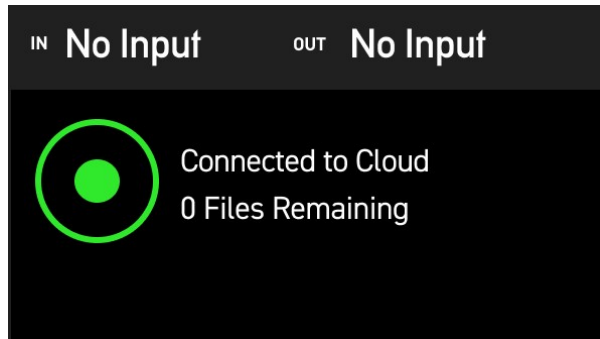

Tapping on the status icon will toggle the visibility of the status text On or Off. This can be toggled whilst idle and also whilst files are uploading.



## Uploading Proxy files to Frame.io

Now that you are connected to a Frame.io project, pressing the REC button will record a clip as usual to the inserted media, as well as generate a 1080p, H.265 (HEVC) proxy file that is saved to a PROXY folder on the inserted media. This proxy file will also be automatically uploaded to the Frame.io project you selected.

After you stop recording, a green arrow will appear in the top left of your NINJA V display, which indicates that the file is being uploaded to Frame.io. The text next to the icon provides details on the progress of the upload and how many files are remaining.



*Full-resolution "hero" clips (up to 4Kp30 ) can be recorded in either Avid DNxHR/HD or Apple ProRes, whilst Proxies will be recorded at 1080p resolution in H.265.*

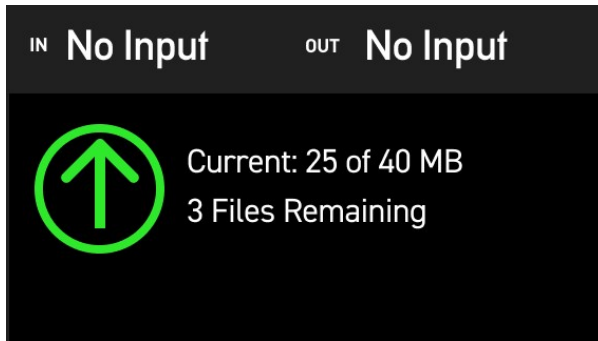

To view the proxy file upload status queue, switch to playback mode and tap on the folder icon to browse recorded files. Then tap on the shortcut to the PROXY folder at the bottom of the screen to open the PROXY folder.

 *Note that the files will not continue to upload to your Frame.io project whilst in playback mode.*



In the Proxy folder, the proxy files displayed will have an icon to the right of each file to indicate the status of the file.

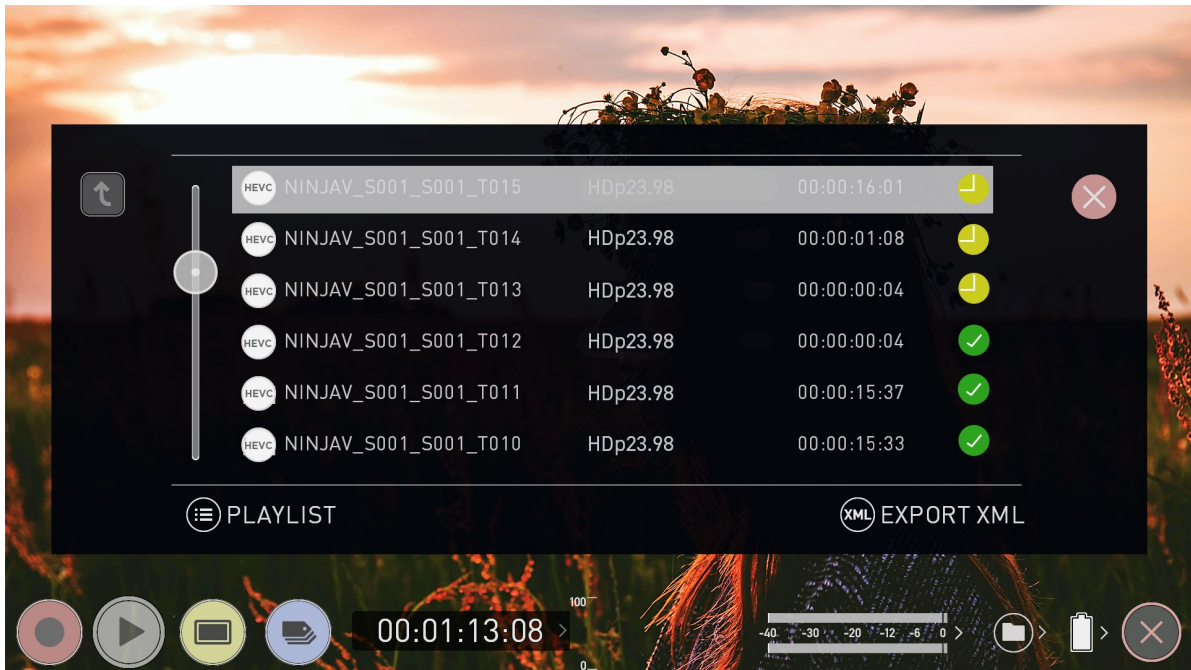

This icon indicates that the file has been successfully uploaded to your Frame.io project.



This icon indicates that the clip is queued for upload to your Frame.io project.



This icon indicates that the proxy clip is a broken video file that has been recovered, and will not be automatically uploaded to your Frame.io project. These clips must be manually uploaded.

Once uploading has completed, your NINJA V will display the green circle icon again, to indicate that the connection is idle.

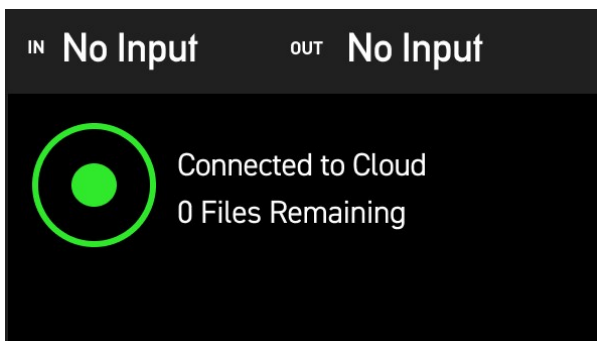

If your device loses the connection with the network, the white circle icon is displayed with the text Device Offline.

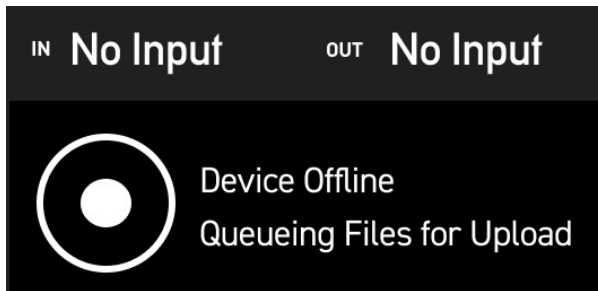

*In the event that your device loses connection with the network whilst shooting, the proxy clips will continue to be generated and saved to the Proxy folder on inserted media. These proxy clips will be queued for upload, and begin uploading to Frame.io when the network connection is restored.*

## Viewing uploaded clips in your Frame.io project

Uploaded clips will appear in a fixed folder structure organized by date in the media tab inside your Frame.io project. Within a folder called Cloud Devices, media that has been written on different dates will upload to the folder that corresponds with the date of upload. The folder structure is as follows:

**Cloud\_Devices > Date > Device Type > Device**



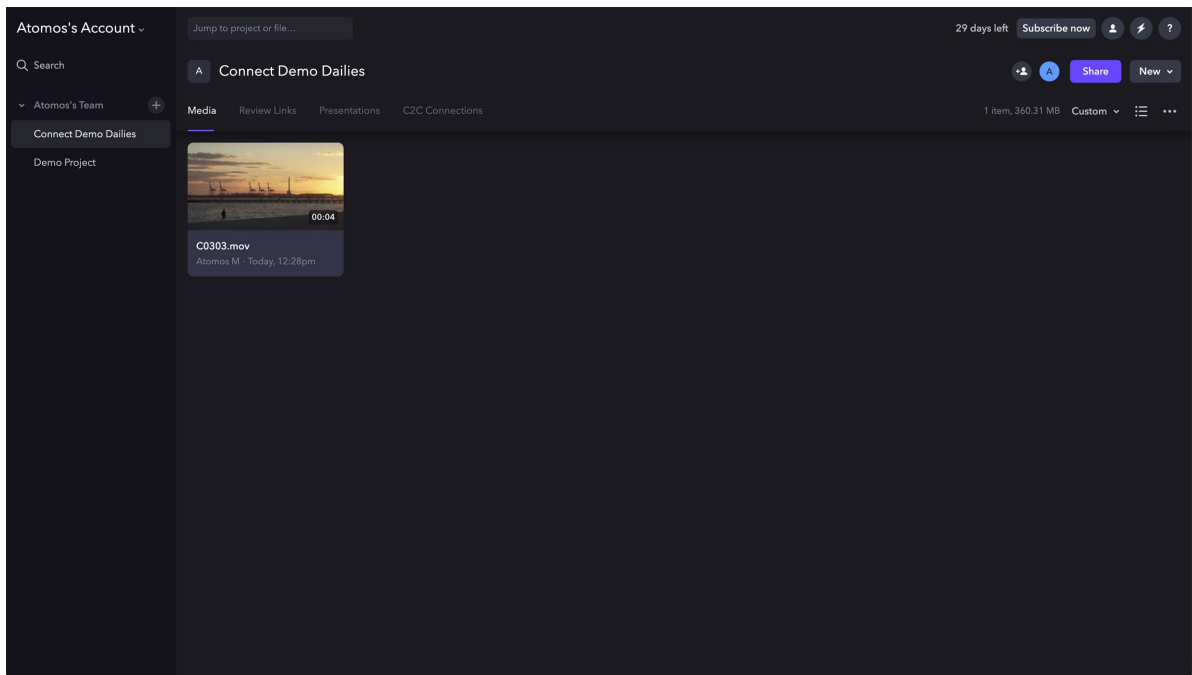

Now that the files from your NINJA V have uploaded to Frame.io, they can be moved, copied, or shared like any other asset in your Frame.io project.

For more information on Frame.io Camera to Cloud, refer to <https://frame.io/c2c/> or watch the Frame.io Training Series at <https://frame.io/c2c-training/>

## Adjusting settings for a Frame.io destination

Clicking on the three dots next to the Frame.io destination for the device, allows you to change the settings for your Frame.io destination or to remove the Frame.io destination.

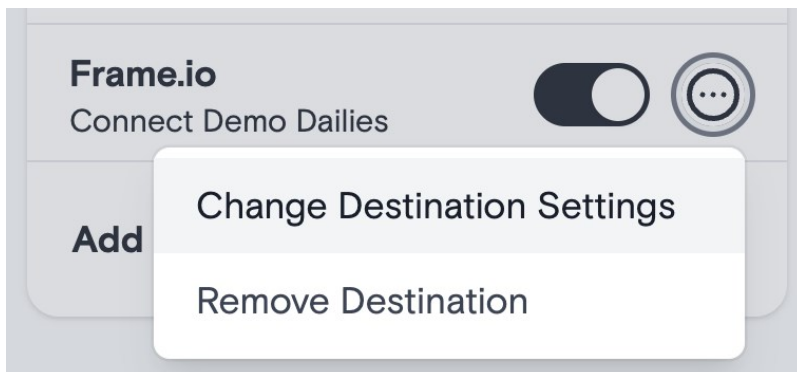

## Connect Menu - Atomos Stream

ATOMOS Stream is designed to make live streaming to popular platforms like YouTube Live, Facebook Live and Twitch easier. You can also choose to stream to a custom RTMP destination, which allows you to connect and stream to destinations other than the platforms listed.

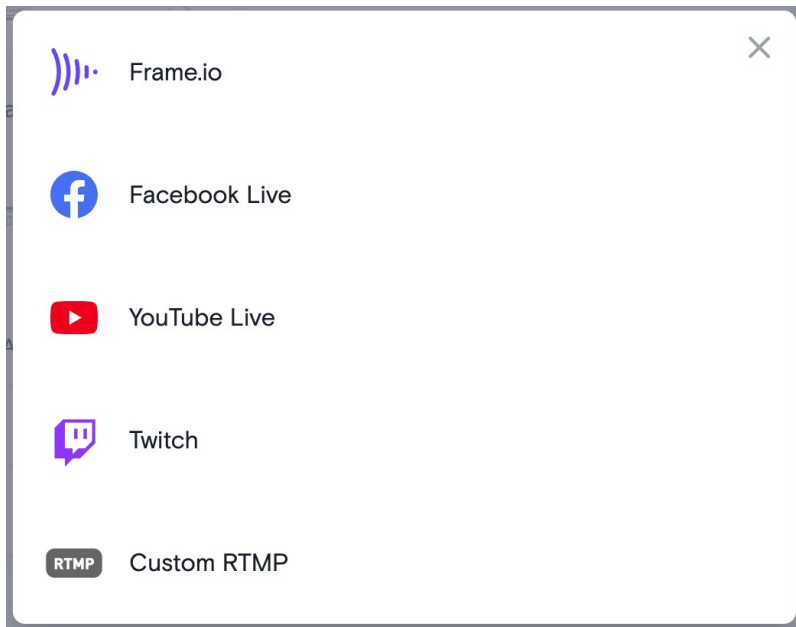

You can choose to work with high-end digital cinema cameras, mirrorless cameras, DSLR, USB cameras or even iOS devices and stream content live to these popular online platforms through your Atomos Cloud Studio account.

In order to stream content from your Atomos Cloud Studio account to one of these platforms, first you will need what is called a Stream Key. This is a unique code generated by each platform, that provides information on where to send the video stream. The following provides guidance on generating a stream key and setting up for streaming on each of the platforms.

Once you have successfully set up a live stream by following the steps below, the Connect menu page on your NINJA V will display the information about the destination. Device Mode is Live Stream, Destination is the destination you are currently connected to in Atomos Cloud and Account Name will also be listed.

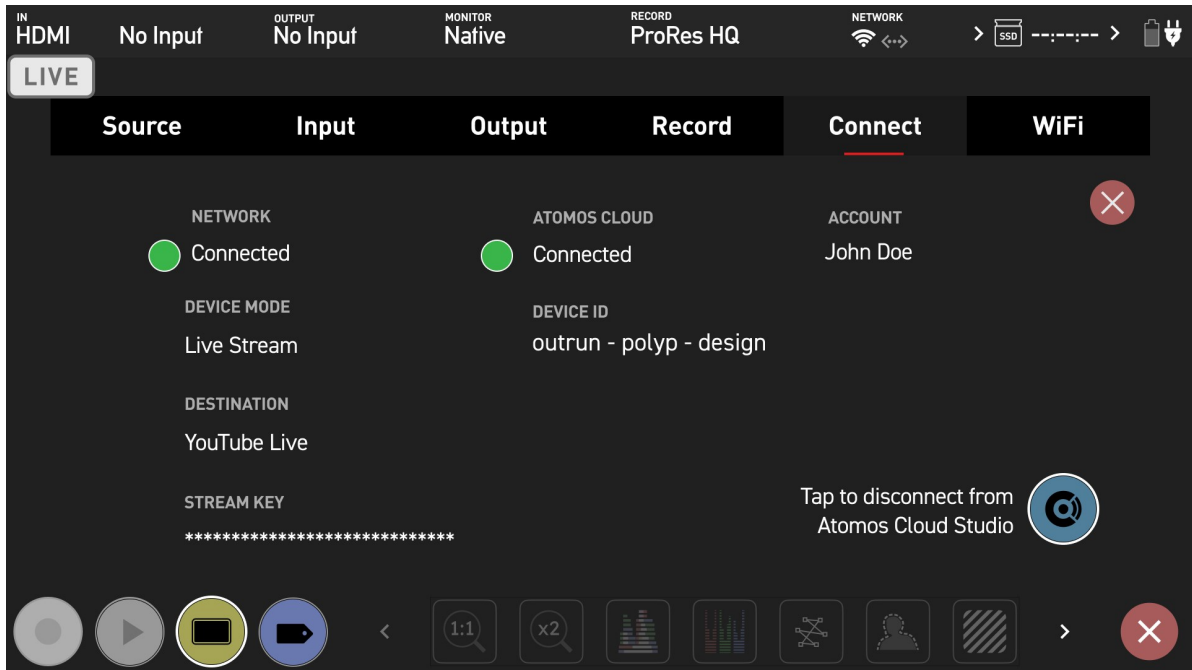

For guidelines on setting a custom RTMP destination on the platforms we've tested and qualified as working, refer to our Custom RTMP Compatibility and Setup Guide article on our support page <https://atomos.zendesk.com/hc/en-us/articles/5489116635791-Atomos-Cloud-Studio-Atomos-Stream-Custom-RTMP-Compatibility-and-Setup-Guide>



*Live Streaming is unavailable if ProRes RAW or H.265 are selected as the record codec. Streaming is only available when using standard video inputs like ProRes and DNx.*



*Changing resolutions and frame rate when Live Streaming mode is enabled may result in the stream stopping. Switching between Record and play back mode will allow the stream to restart. Press the LIVE button to stop the stream before changing inputs, resolutions or frame rates.*

## Streaming to Facebook Live



*Facebook requires that a desktop device be used to generate a Stream Key for Facebook Live. If you only have access to a mobile device, you can*



request the desktop version of the Facebook website from the mobile browser. Then you can follow the steps below.

## To create a live stream on Facebook:

1. Go to [facebook.com/live/producer](https://facebook.com/live/producer)

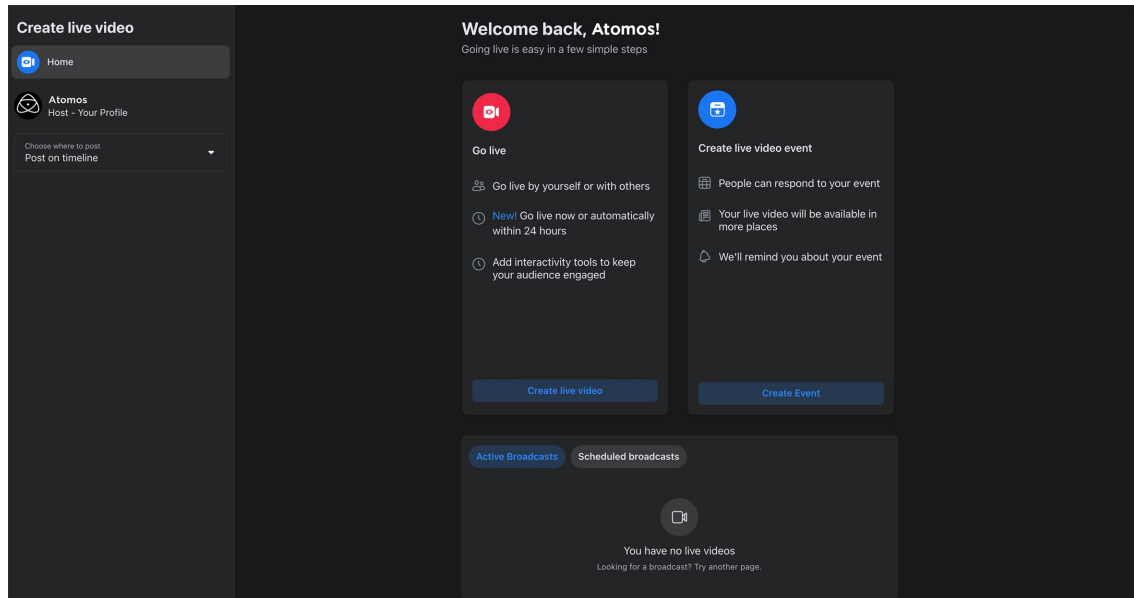

2. In the Go Live box, click on Create Live Video.

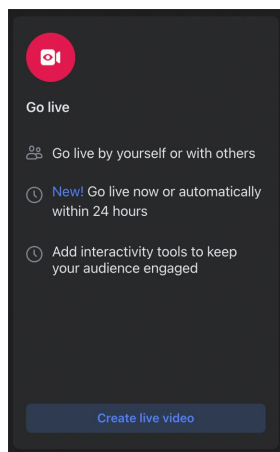

3. The main settings page will open.

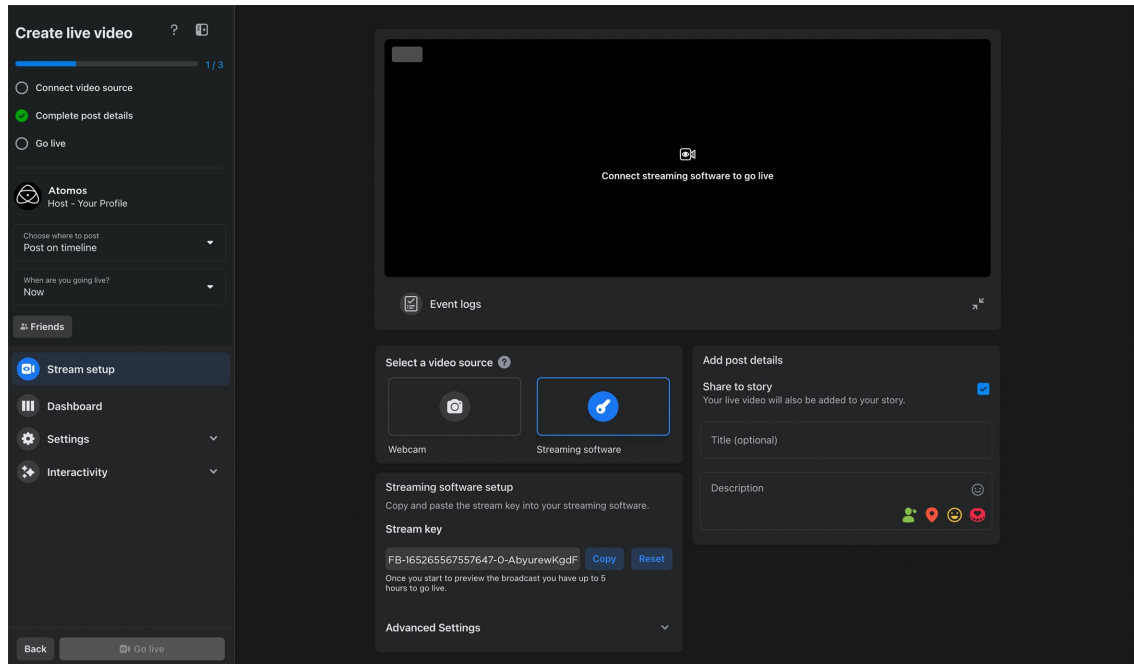

4. In the left side of the screen under Create Live Video, click on the drop-down arrow at 'Choose where to post', to select where the video will be posted. Options here include posting on your timeline, posting to a page you manage and posting to a group.

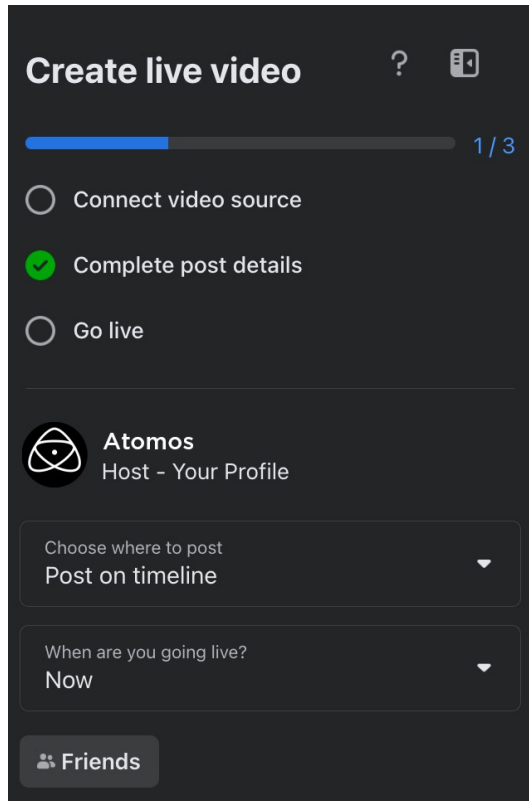

5. Click on the drop-down arrow at 'When are you going live?', to select when you want to go live. Select Now to go live when you are finished adjusting the settings. If you select Later, you can enter the date and time that you want to go live.
6. On the right side of the screen, you can add a title and description for the stream. A tick-box also allows you to select whether to add to your story.

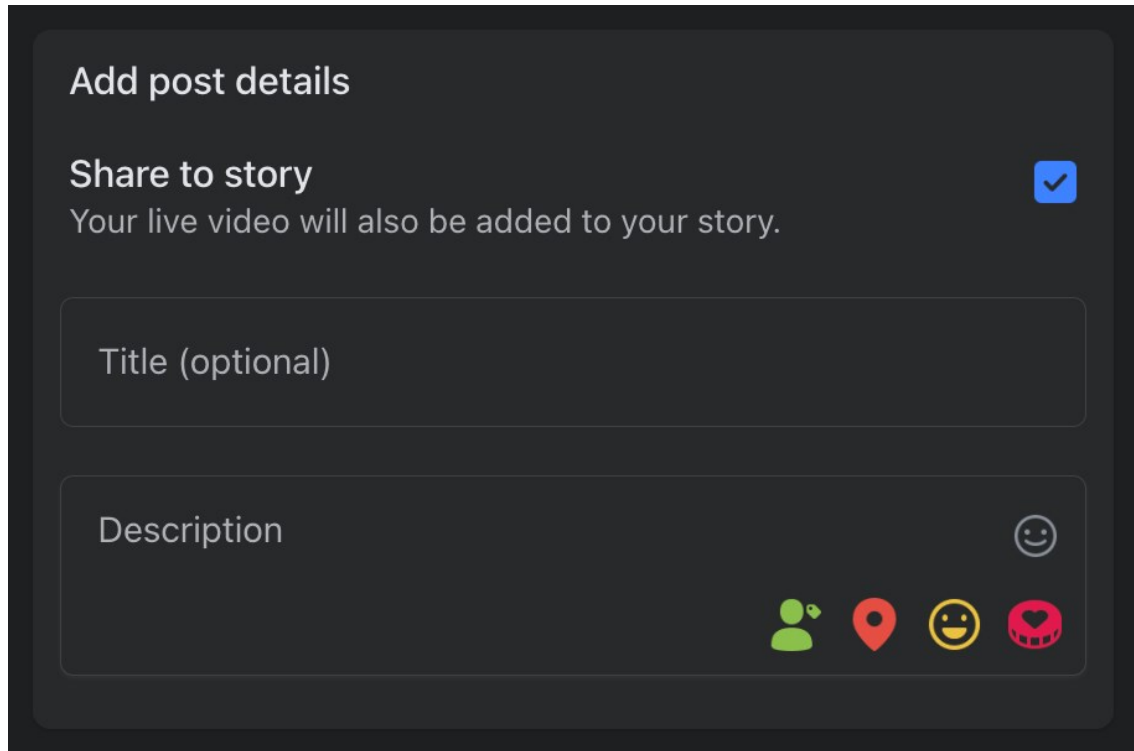

7. At Select a video source, select Streaming Software.

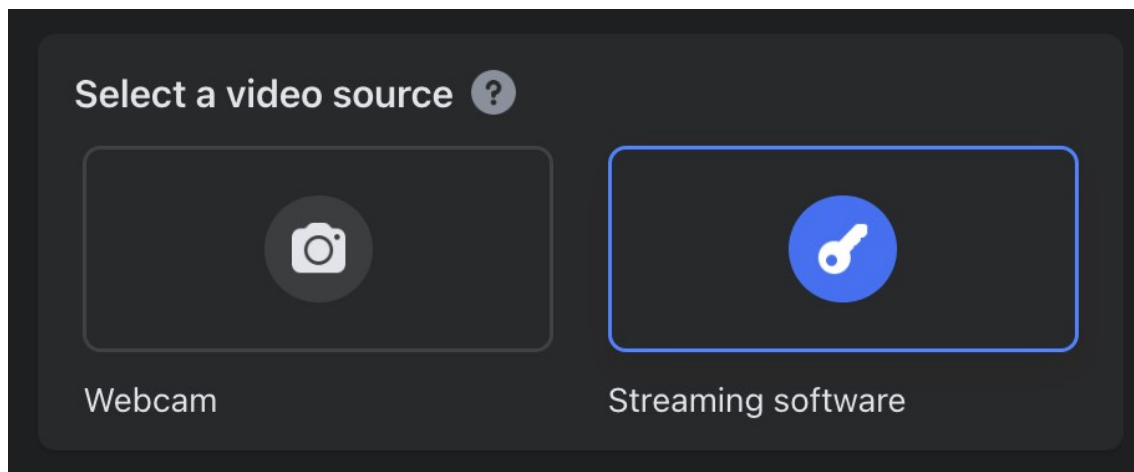

8. Click on the Advanced Settings drop-down menu to view the advanced settings. Toggle the switch at 'Persistent Stream Key' to On, so that you can use this stream key every time you stream to Facebook Live from your NINJA V.

**Advanced Settings** 

---

**Persistent stream key**   
This can be reused every time you go live. You can only broadcast one live video at a time with your persistent stream key.

**Backup stream**   
Once a backup stream is added to your live video, it cannot be removed. It will not affect your stream if you choose not to use it.

**Server URL**

`rtmps://live-api-s.facebook.com:443/rtmp/` 

This may be referred to as "URL" or "Address" in your streaming software.

9. Click the Copy button next to the Stream Key to copy it.



## Streaming software setup

Copy and paste the stream key into your streaming software.

### Stream key

FB-165265567557647-O-AbyurewKgdF

Copy

Reset

Once you start to preview the broadcast you have up to 5 hours to go live.

10. In your browser, log into [atomos.cloud](https://atomos.cloud) and click on the '+' symbol at Add Destination for the NINJA V device you want to stream from.

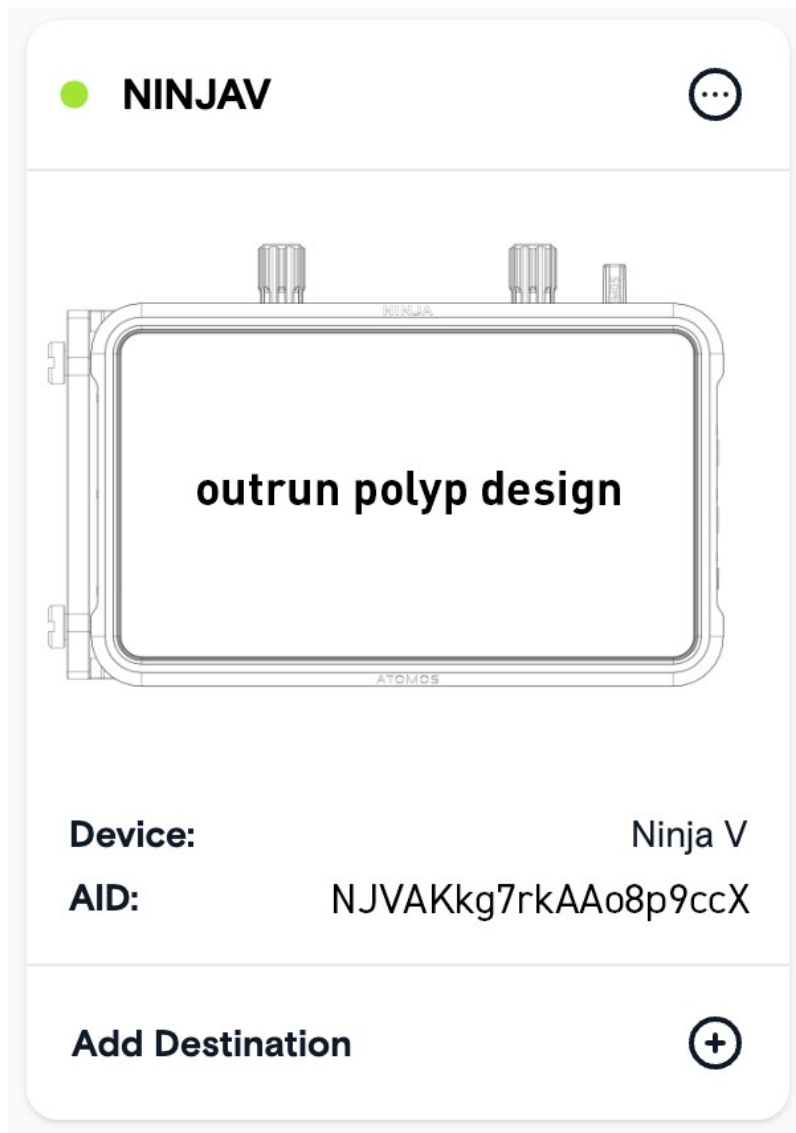

11. Select Facebook Live in the popup box that appears.

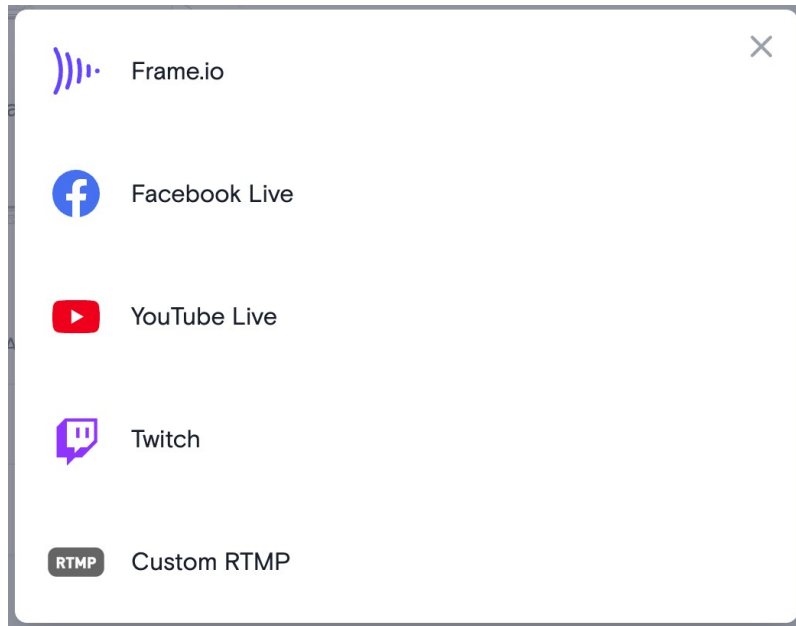

12. In the next popup box, add a description for the stream. Right click in the Streaming Key field and select Paste, to paste the Facebook Live streaming key that you copied. Click on Done to save the destination settings.

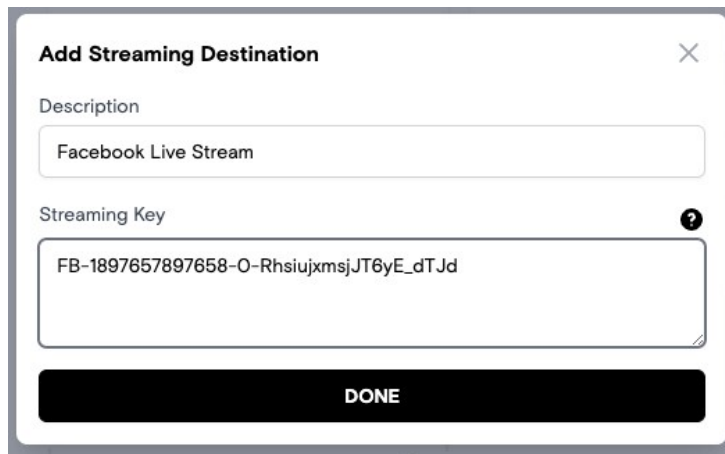

13. Facebook Live will now appear as a destination at the bottom of the device box in Atomos Cloud. Toggle the switch at Facebook Live to On.

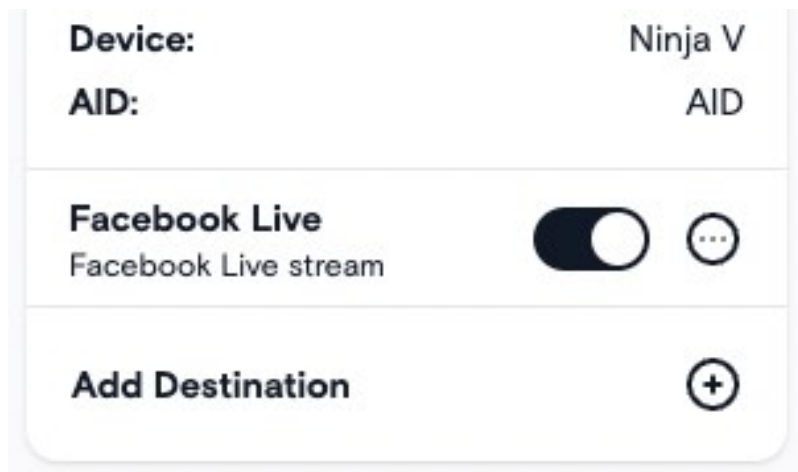

14. Tap on the LIVE icon in the top left corner of your NINJA V display to start streaming from your device.



15. You will be asked if you are ready to start live streaming. Tap on Confirm to proceed.

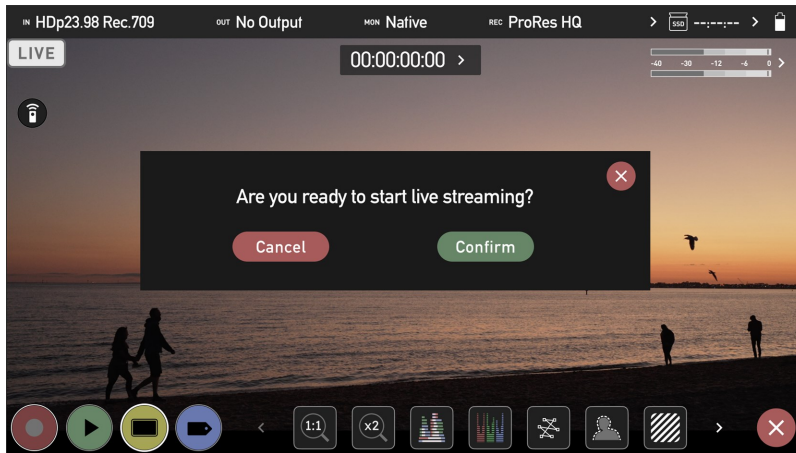

16. The LIVE icon will turn yellow to indicate that your device has begun to connect.

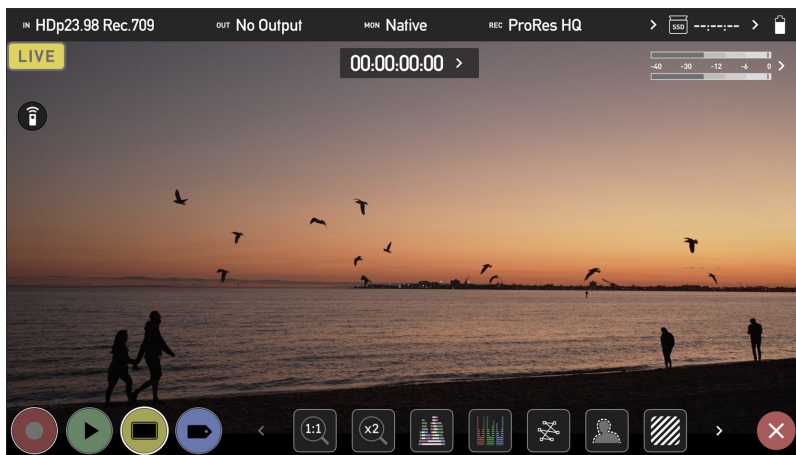

17. The LIVE icon will turn red once the stream has been acknowledged by the server. This indicates that you are currently live streaming.

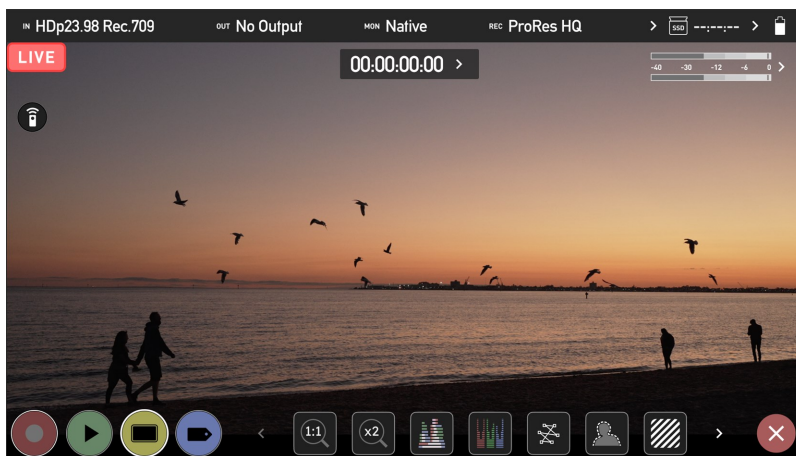

18. A preview screen will appear on the Facebook settings page with the image from your camera

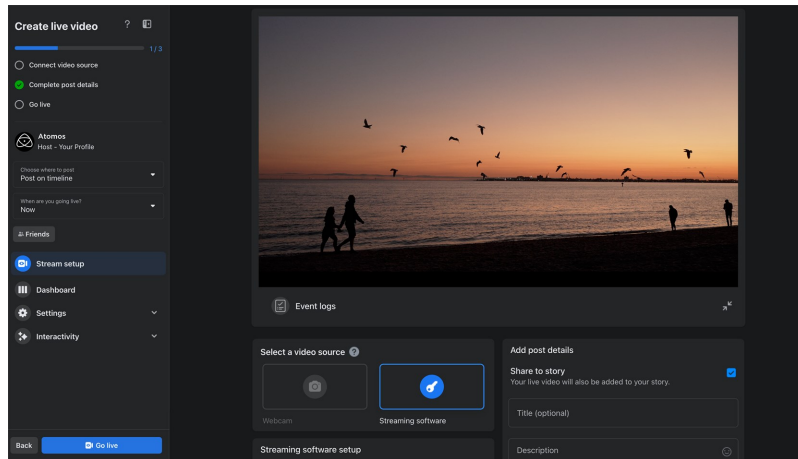

19. Click on the Go Live button, to start streaming to Facebook Live.

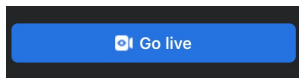

20. Tap the red LIVE button on your NINJA V display when you want to stop live streaming to Facebook. You will be asked to confirm your decision. Tap Confirm to proceed.

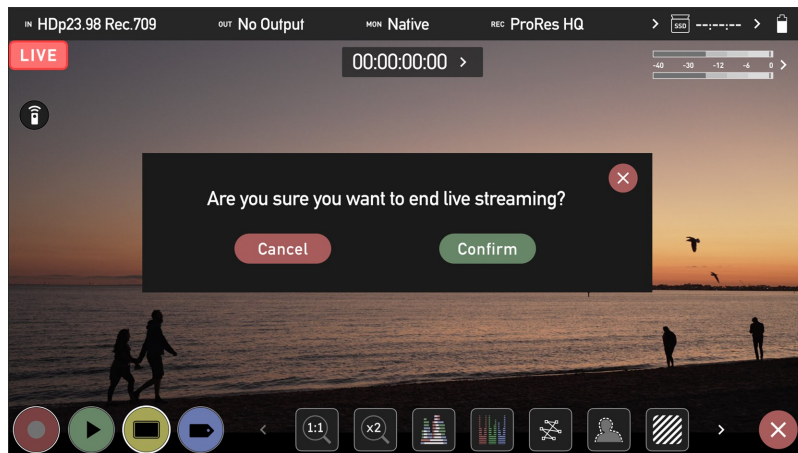

21. Your device will stop streaming, and the LIVE button will turn white to indicate that you are no longer streaming.

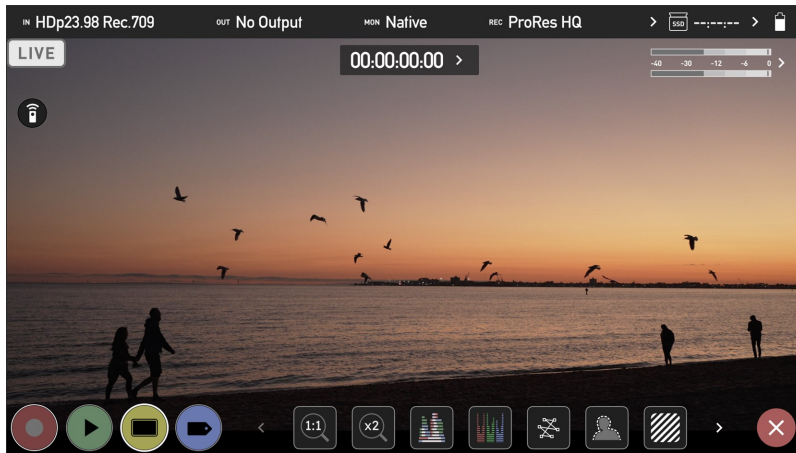

For more information and details on creating a Facebook Live stream, refer to

[facebook.com/help/587160588142067](https://facebook.com/help/587160588142067)

## Streaming to YouTube Live

When using your NINJA V with ATOMOS CONNECT to stream to YouTube Live, your CONNECT is viewed as an encoder, and must be set up in YouTube as such.

### How to create a YouTube live stream with ATOMOS CONNECT

1. Navigate to [youtube.com](https://youtube.com) and sign in to your YouTube account. Create an account if you do not already have one.

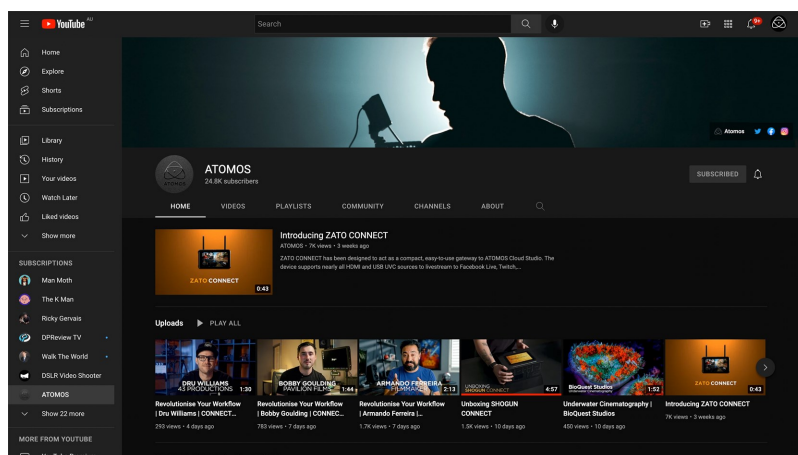

2. Click on the Create icon in the top right corner and select Go Live from the drop-down to open the YouTube Live Control Room.

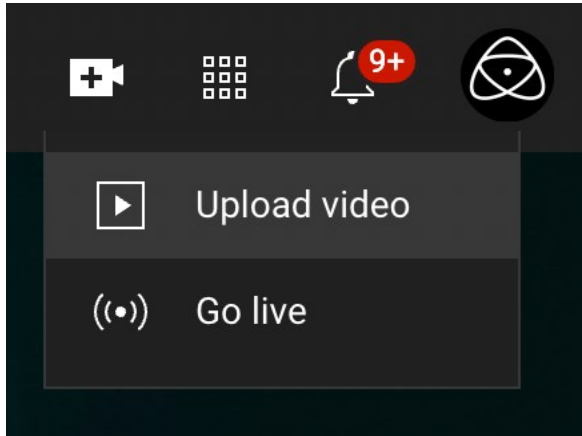

3. If you have not yet verified your YouTube channel, you will need to verify your channel before proceeding

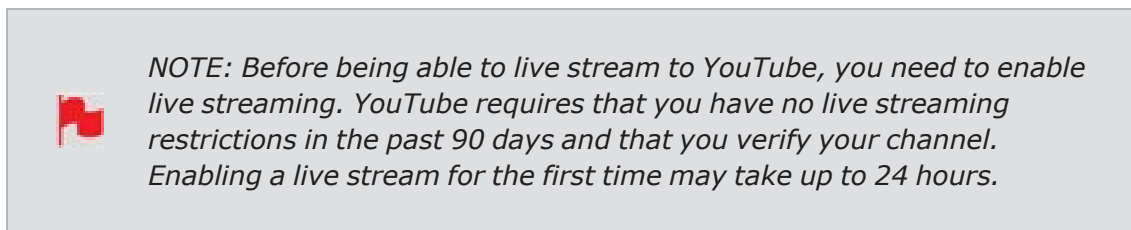

4. A pop-up may appear, asking you to choose when to go live. Options are Right Now and at a Later Date. Click the Start icon in one of the boxes to proceed. If you select Right Now, you will then need to select Streaming Software as the type of stream from the next pop-up screen. The YouTube studio will open.

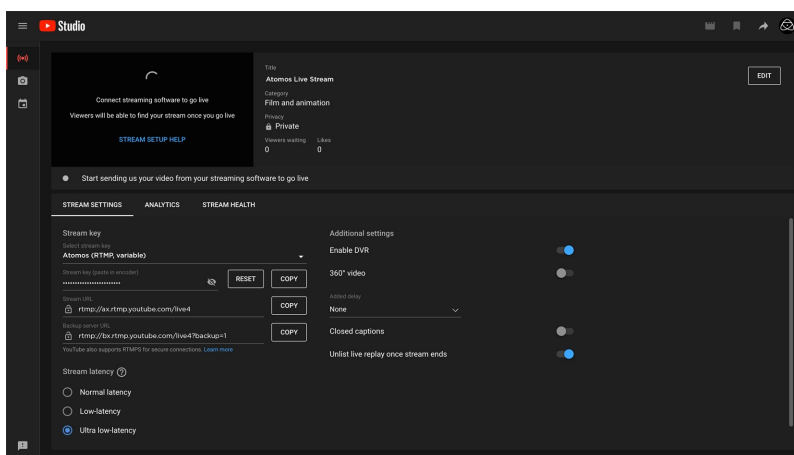



5. Click the Copy button next to the Stream Key to copy it.

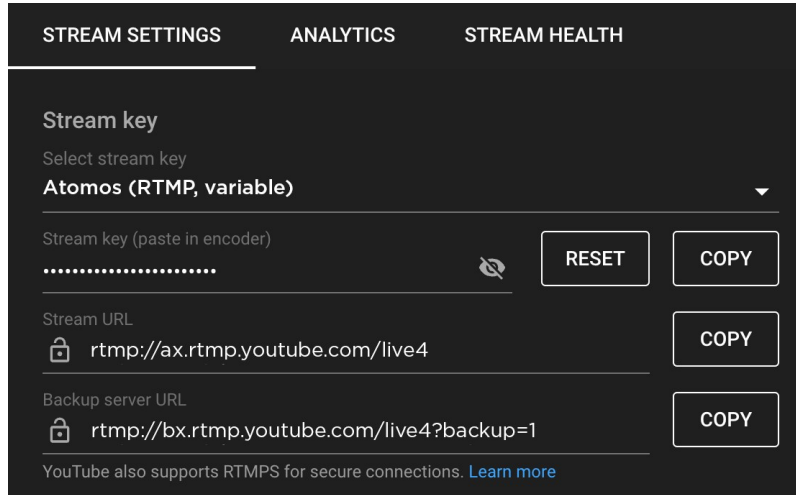

6. In your browser, log into atomos.cloud and click on the '+' symbol at Add Destination for the NINJA V device you want to stream from.

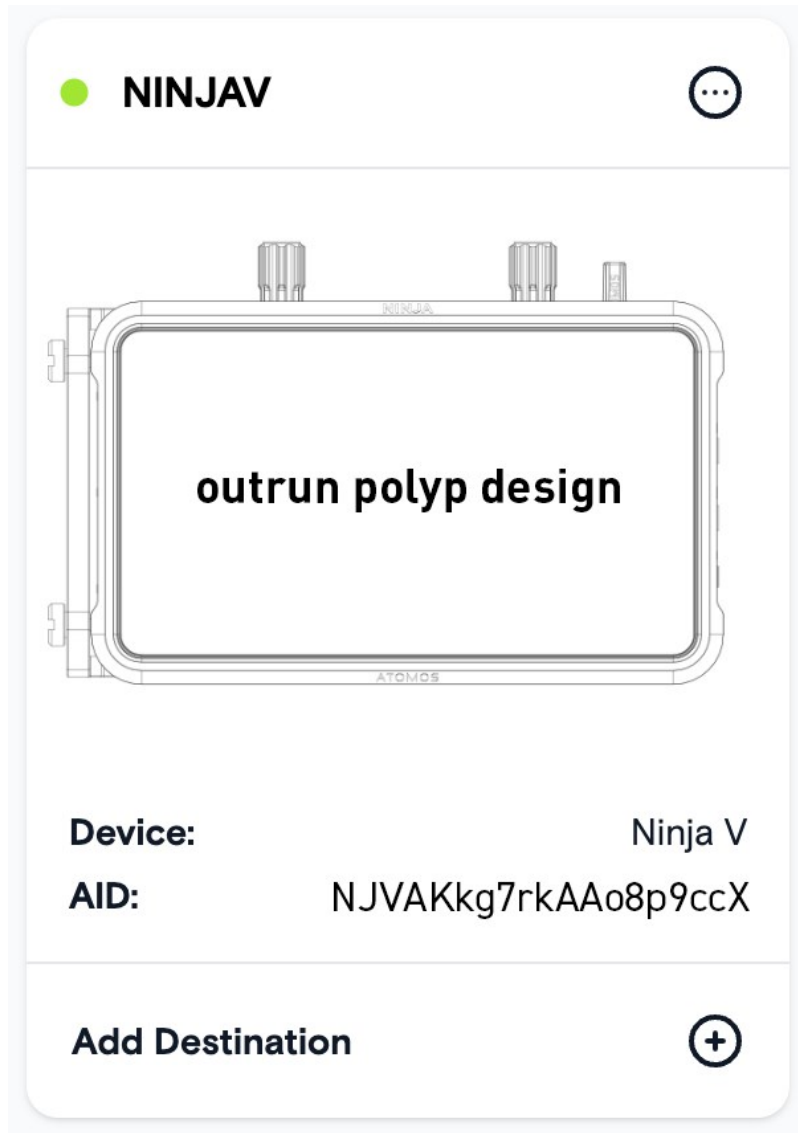

7. Select YouTube Live.

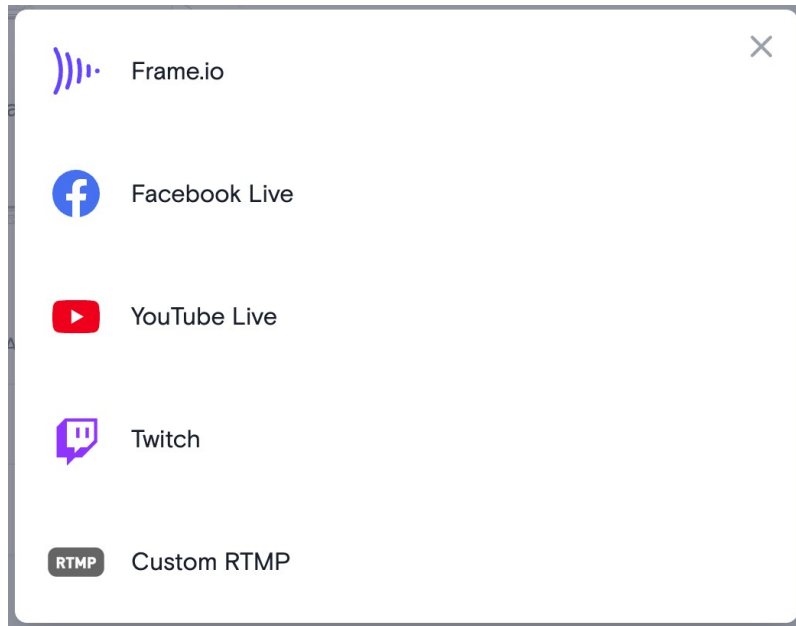

8. In the popup box that appears, add a description for the stream and click on the drop-down arrow at Server to select a server to use. Right click in the Streaming Key field and select Paste, to paste the YouTube Live streaming key that you copied. Click on Done to save the destination settings.

A white rectangular form titled "Add Streaming Destination" with a close button (X) in the top right corner. It contains four input fields and a button at the bottom:

- Name:** A text input field.
- Server:** A dropdown menu currently showing "Primary" with a downward arrow. Below it is the URL "rtmps://a.rtmps.youtube.com/live2".
- Streaming Key:** A text input field with a question mark icon to its right.
- Quality:** A dropdown menu currently showing "High" with a downward arrow.

At the bottom of the form is a dark grey button labeled "Done".

9. YouTube will now appear as a destination at the bottom of the device box in Atomos Cloud. Toggle the switch at YouTube Live to On.



10. Tap on the LIVE icon on your NINJA V display.



11. You will be asked if you are ready to start live streaming. Tap on Confirm to proceed.

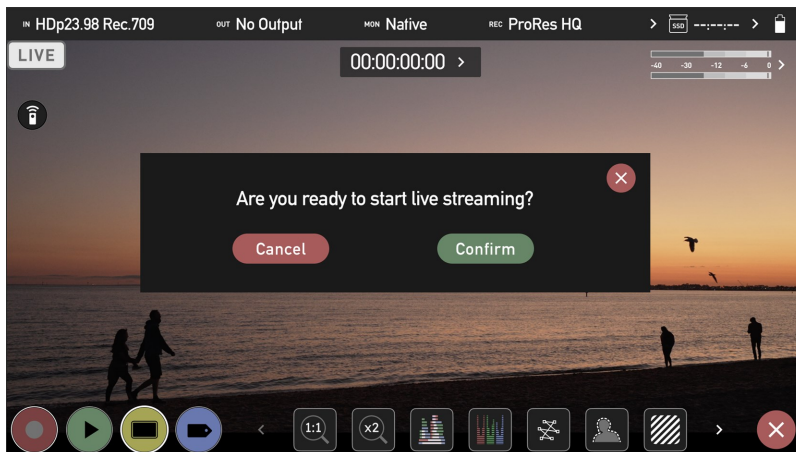

12. The LIVE icon will turn yellow to indicate that your device has begun to connect.

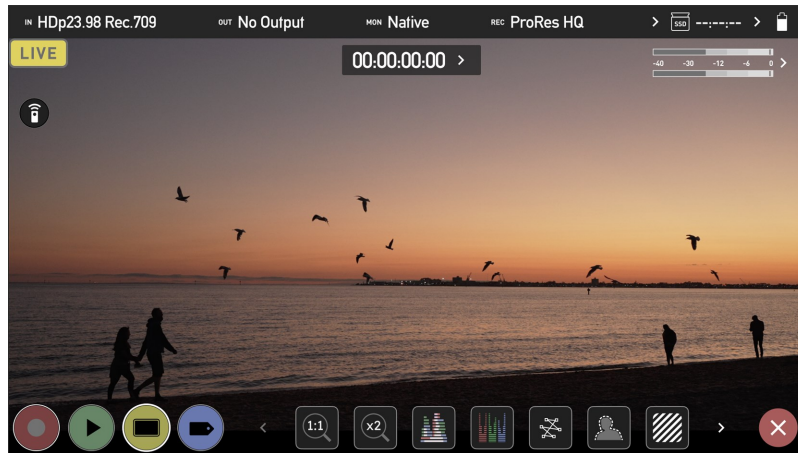

13. The LIVE icon will turn red once the stream has been acknowledged by the server. This indicates that you are currently live streaming.

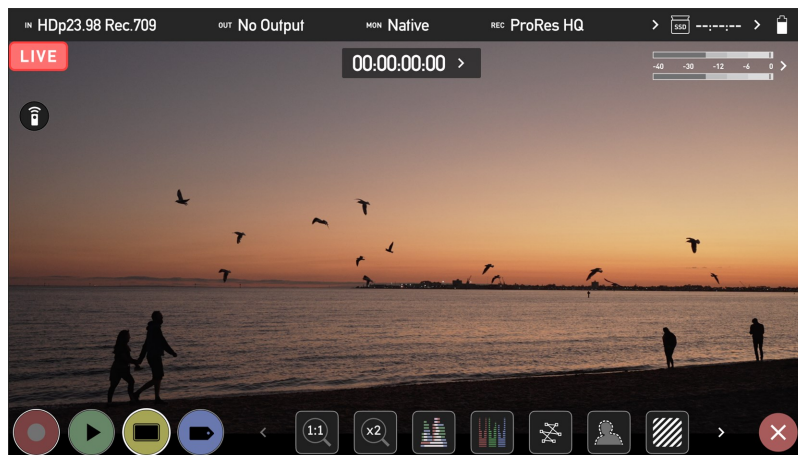

14. A preview screen at the top of the YouTube Studio settings page will display the image from your camera. The words LIVE and the elapsed time of the stream will be displayed whilst you are live streaming to YouTube.



15. The Stream Settings tab below the preview screen allows you to adjust the stream latency and other settings for the stream.

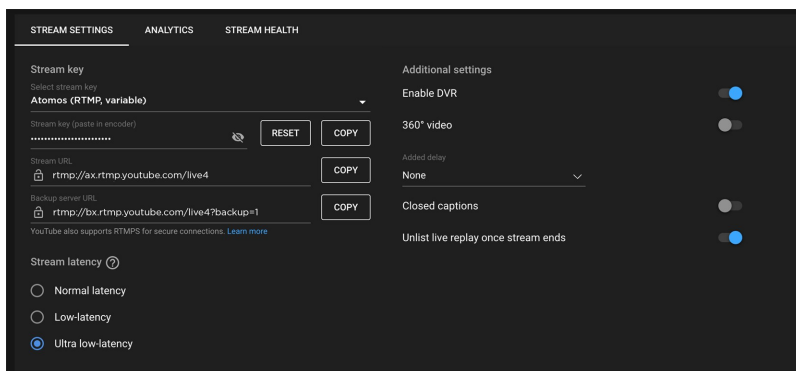

16. Tap the red LIVE icon on your NINJA V display to stop live streaming. You will be asked to confirm your decision. Tap Confirm to proceed.

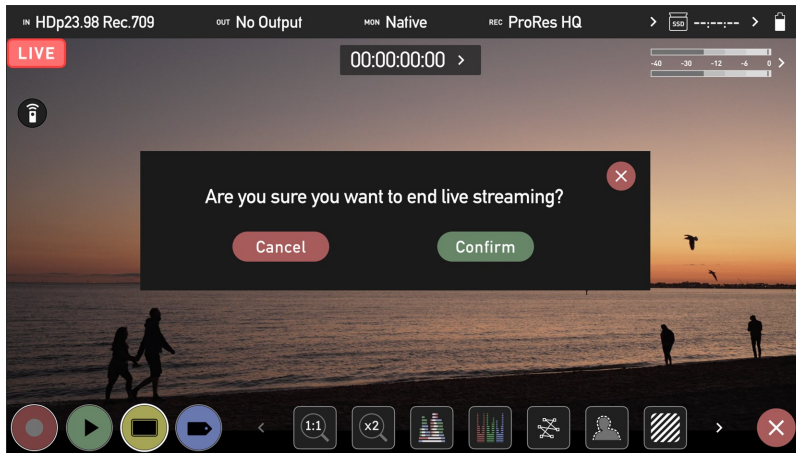

17. Your device will stop streaming, and the LIVE button will turn white to indicate that you are no longer streaming.

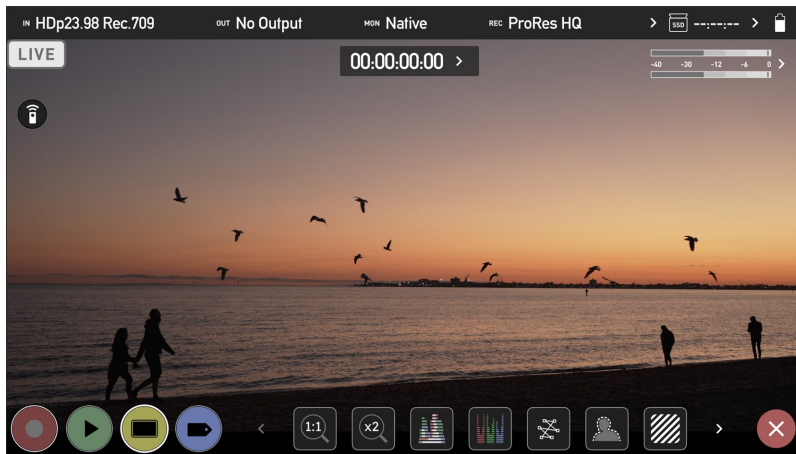

18. To end the live stream from within YouTube, click on End Stream in the top right hand corner of the screen.

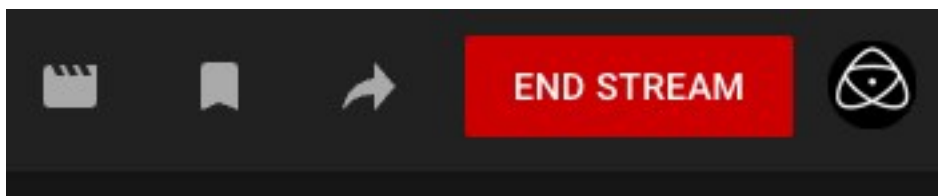

For more information and details on creating a YouTube live stream, refer to [support.google.com/youtube/answer/2907883?hl=en](https://support.google.com/youtube/answer/2907883?hl=en)

## Streaming to Twitch

1. Create a Twitch account at twitch.tv or log into your existing Twitch account.

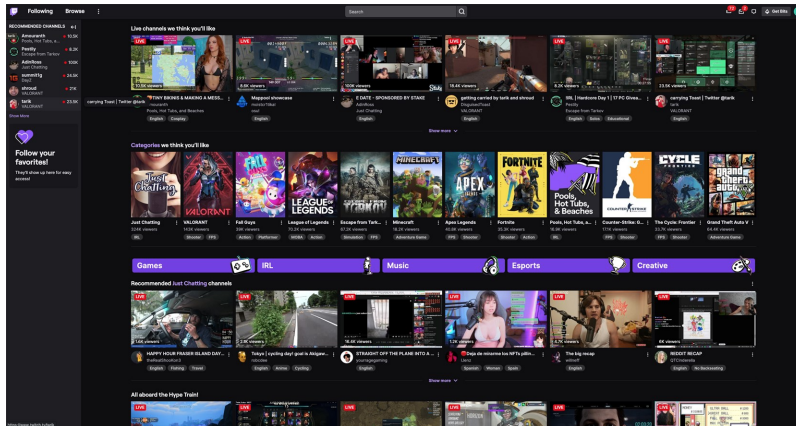

2. Click on your profile picture icon in the top right corner of the screen and select Video Producer.

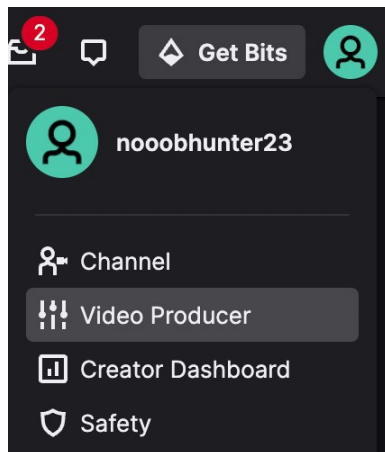

3. The Video Producer interface will open.



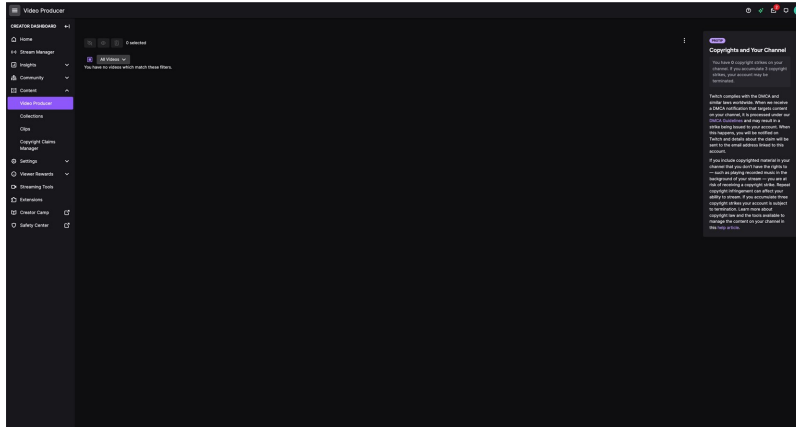

4. Click on Settings in the pane on the left side of the screen, then click on stream from the drop-down menu.

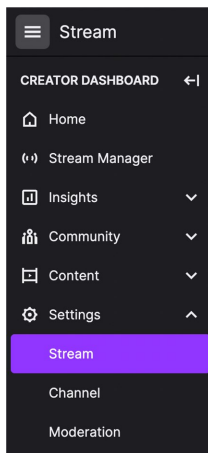

5. The Stream Key and Preferences window will open. Click on the copy button to copy the stream key. Note that this window provides latency and other settings for that can be adjusted.

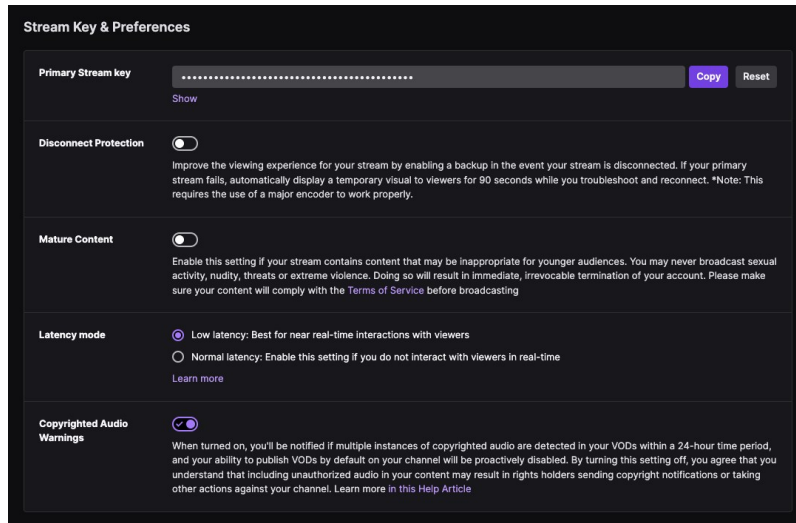

6. In your browser, log into atomos.cloud and click on the '+' symbol at Add Destination for the NINJA V device you want to stream from.

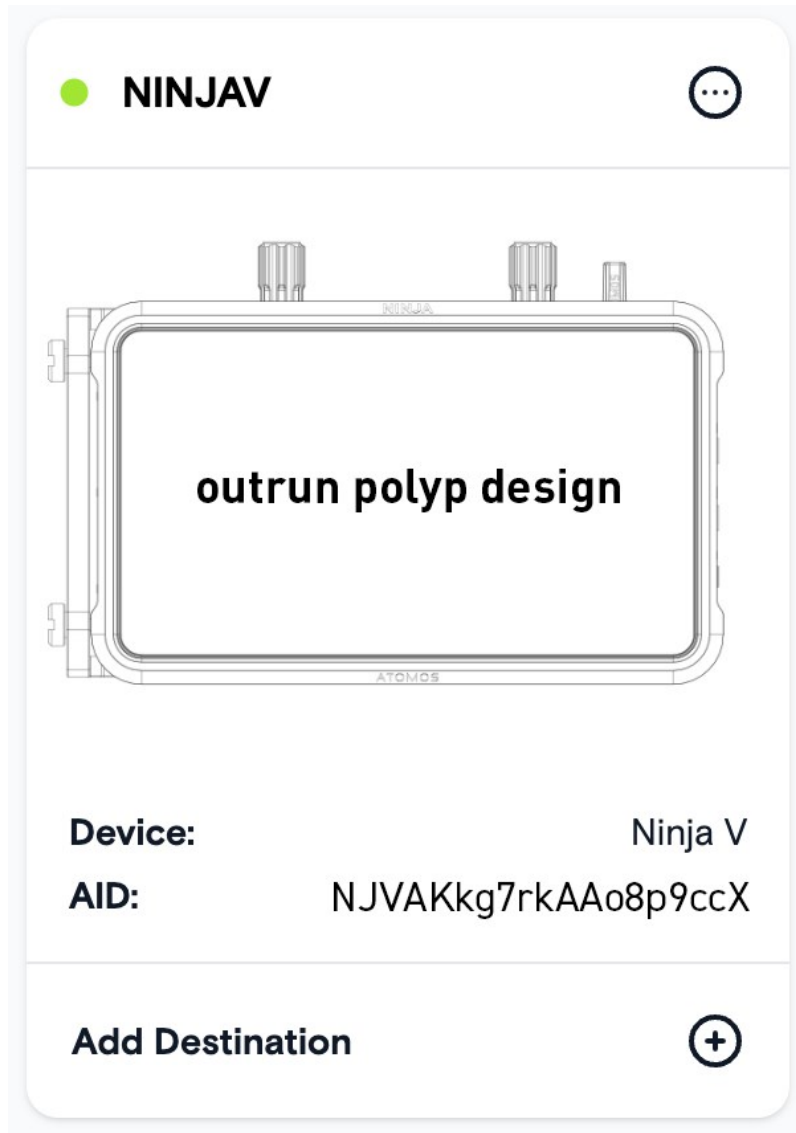

7. Select Twitch.

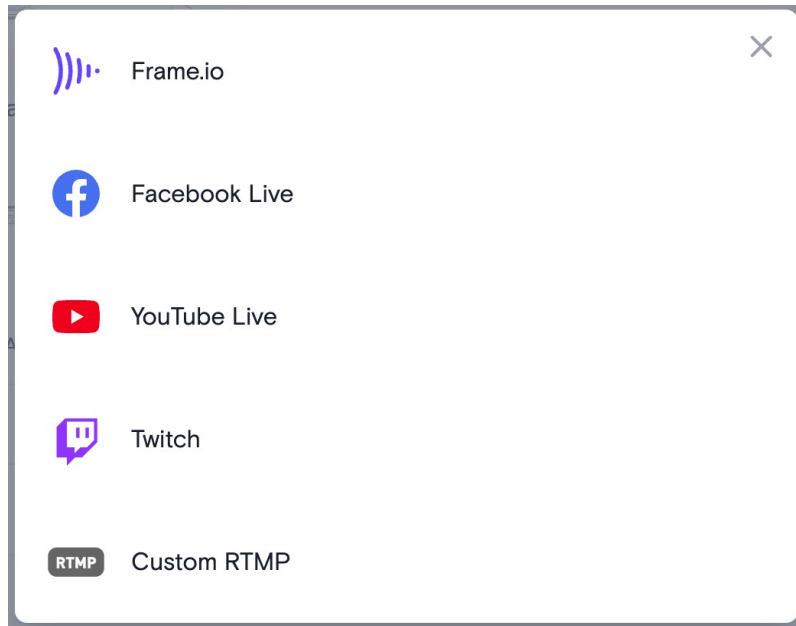

8. In the popup box that appears, add a description for the stream and click on the drop-down arrow at Server to select a server to use. Right click in the Streaming Key field and select Paste, to paste the Twitch streaming key that you copied. Click on Done to save the destination settings.

9. Twitch will now appear as a destination at the bottom of the device box in Atomos Cloud. Toggle the switch for the Twitch destination to On.

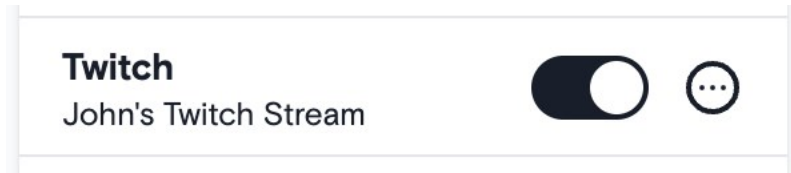

10. Tap on the LIVE icon in the top left corner of your NINJA V display.

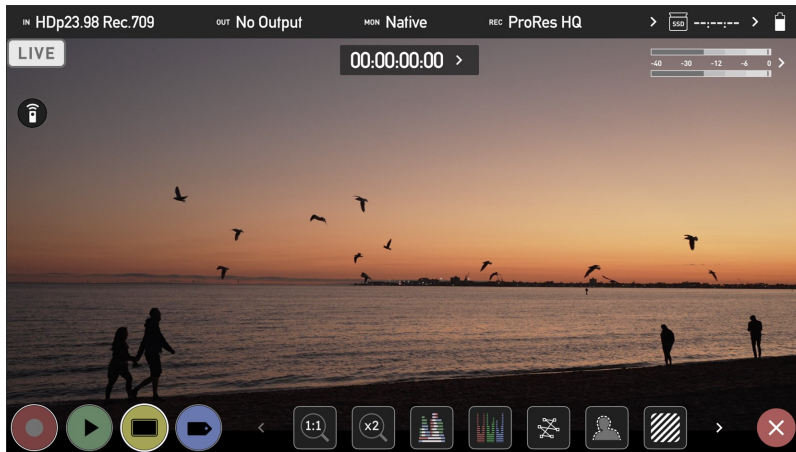

11. You will be asked if you are ready to start live streaming. Tap on Confirm to proceed.

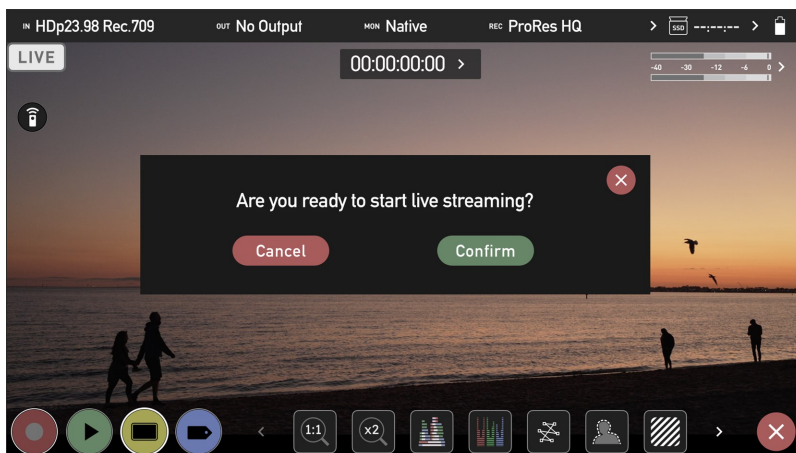

12. The LIVE icon will turn yellow to indicate that your device has begun to connect.



13. The LIVE icon will turn red once the stream has been acknowledged by the server. This indicates that you are currently live streaming.

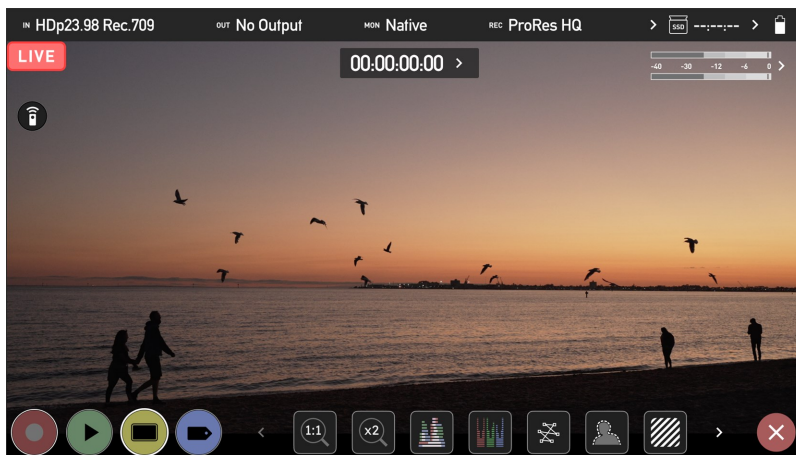

14. Click on Stream Manager in the side pane.

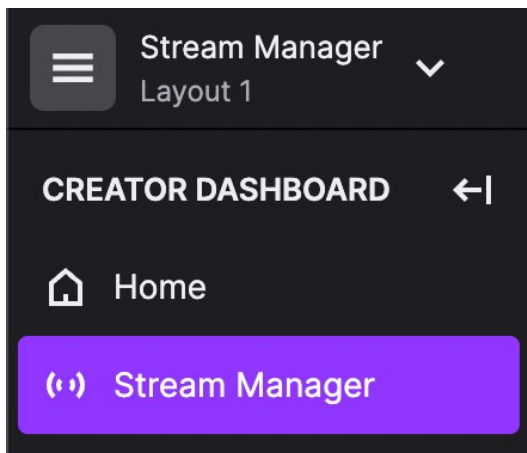

15. The Stream Manager page will open, and the image from your device will be shown on-screen.

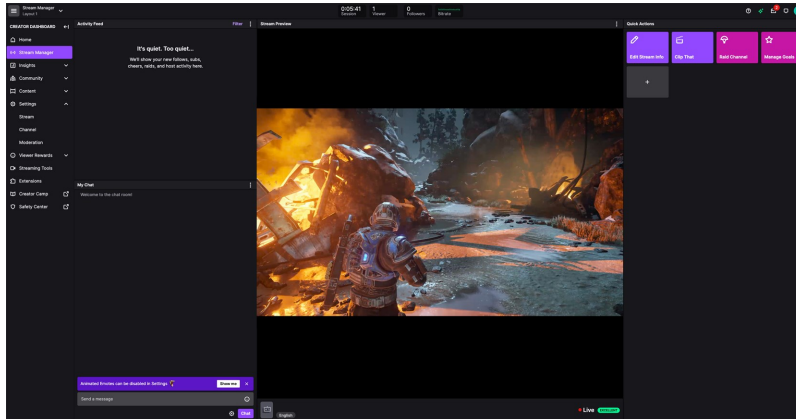

16. Below the image, a red dot and the word LIVE will be displayed when you are live. The status/stability of the stream will also be indicated by a colored icon. The green box with the word 'Excellent' is an example of this.

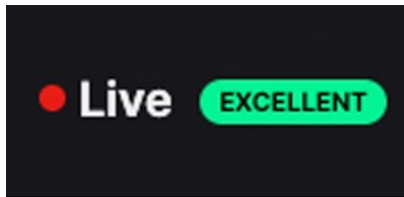

17. Hovering over the image will bring up some additional settings that can be adjusted.



18. Tap the LIVE icon on your NINJA V display to stop live streaming. You will be asked to confirm your decision. Tap Confirm to proceed.

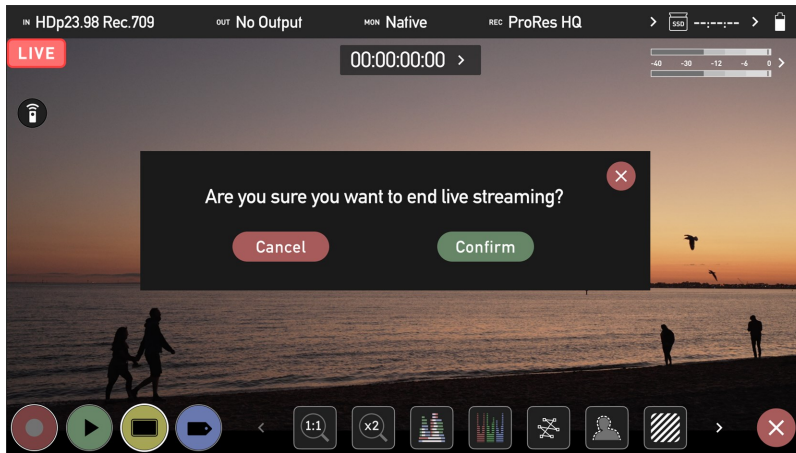

19. Your device will stop streaming, and the LIVE button will turn white to indicate that you are no longer streaming.

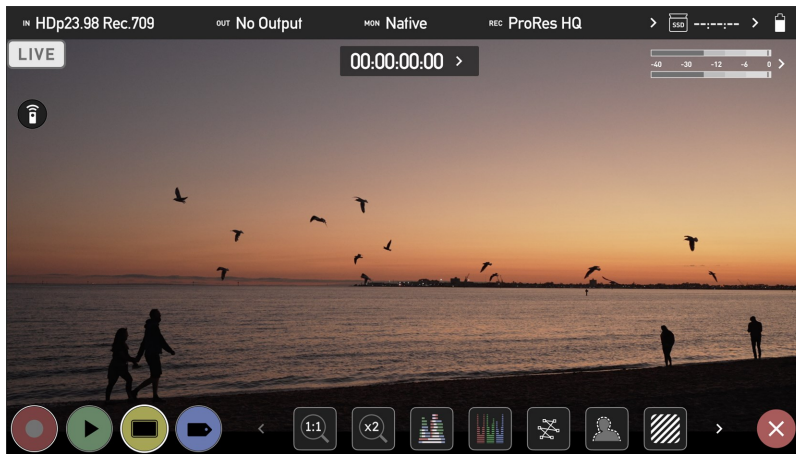

20. The word Offline will be displayed under the image in your browser when you are not live streaming.

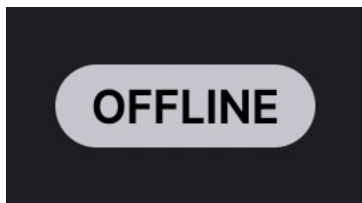

For more information on streaming to Twitch, refer to [help.twitch.tv/s/](https://help.twitch.tv/s/)



# Timelapse Menu

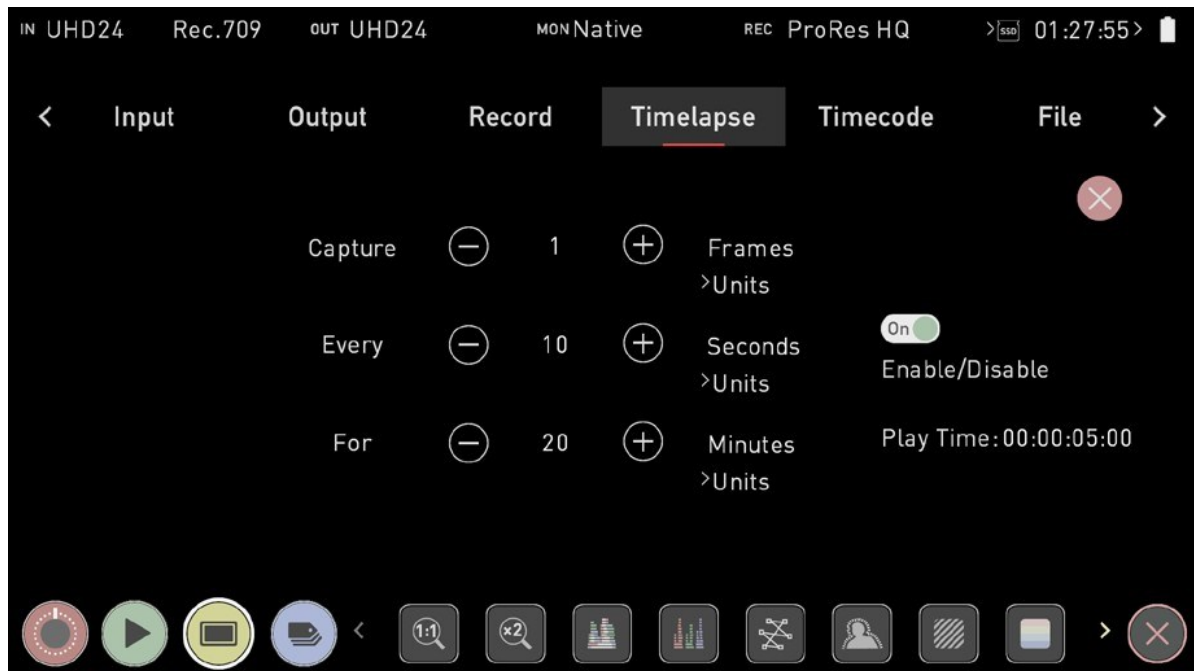

This menu allows you to set up recording of a time-lapse sequence as a single video file in ProRes, DNx or ProRes RAW from an HDMI or SDI source.

Time-lapse sequences are used to create dynamic videos showing changes in light or movement in a scene over time. Images are captured at set intervals like 1 frame every 10 seconds and saved to the video file in sequential order, so when the time-lapse video is played back at a frame rate of 24 frames per second, time is compressed and the changes in the scene appear more pronounced. Examples of this are time-lapse recordings of a sunset or sunrise, or the construction of a building.

The options in this menu allow you to specify the settings for a time-lapse recording. An example of common time-lapse settings might be as follows: capture 1 frame every 10 seconds for 20 minutes.



*Note that if you select multiple frames/seconds to be captured in the first setting in the example above, these frames/seconds will be captured sequentially. So if you select 15 frames here, it will capture 15 frames as a block every 10 seconds for a duration of 20 minutes.*

## Capture

The capture setting allows you to specify the number of frames/seconds to capture at each interval.

Eg. **Capture X frames/seconds.**

+ / -:

Use these icons to adjust the numerical setting

### Units:

Tap to cycle between the following options to be used as a unit:

- Frames
- Seconds



## Every

This setting allows you to specify the intervals at which the capture should occur.

Eg. **Every X seconds / minutes / hours.**

+ / -:

Use these icons to adjust the numerical setting.

### Units:

Tap to cycle between the following options to be used as a unit:

- Seconds
- Minutes
- Hours

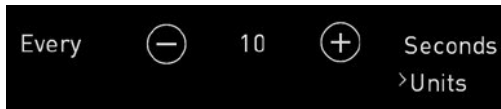

## For

This setting allows you to specify the duration that the capture should continue for.

Eg. **For X frames / seconds / minutes / hours**

+ / -:

Use these icons to adjust the numerical setting

## Units:

Tap to cycle between the following options to be used as a unit:

- Frames
- Seconds
- Minutes
- Hours

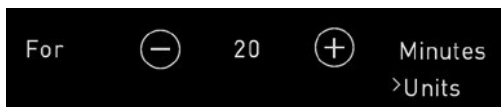

## Enable/Disable (On/Off)

When you are ready to begin your time-lapse recording, tap on the Enable/Disable toggle to select the On setting.

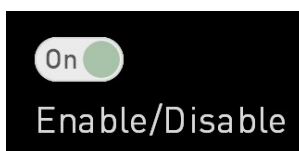

When time-lapse recording is enabled and you have an input connected and media inserted, the REC button will change to the time-lapse REC button. This allows you to see at a glance whether you are in the standard record mode or time-lapse record mode.

Tap on the time-lapse REC button to begin recording. Your NINJA V will record the time-lapse sequence as a single video file, using the codec and compression settings selected on the Record page.

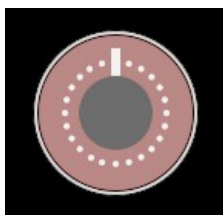

The following icon will also appear in the top right corner of your screen to indicate that a time-lapse is being recorded.



During a time-lapse recording, the length of time that you have been recording will be displayed in the upper right corner of the screen. The timecode will display the actual number of frames captured.



## Play Time

As you adjust the time-lapse settings, the Play Time in the bottom right updates to let you know the duration of the final video based on the selected settings.



*Note that the pre-roll feature is not supported when using time-lapse.*



*When you have finished using the time-lapse feature, make sure that you use the Enable/Disable toggle to disable the time-lapse recording feature to return to regular video capture mode.*



*If you want to stop the time-lapse recording before the set duration finishes, simply tap on the stop button.*

# Timecode Menu



**Timecode Display:** Displays the current timecode. The position of the timecode display will depend on the screen mode you are using. In monitoring mode it appears in the center top, below the info bar. In home screen mode the timecode display sits on the bottom near the REC PLAY MON EDIT icons. Touching the Timecode display will take you to this Timecode menu screen.

00:00:15:00

The timecode modes that are supported:

- HDMI (Embedded)
- Record Run
- Time of Day
- Auto Restart
- AtomX Sync
- Atomos CONNECT

## Hour / Minute / Second / Frame

These settings will be enabled when using the Auto Restart mode, and allow you to define a timecode that will be used for all clips whenever you press record. Use the - and + icons above each unit to adjust the numerical values for the hour, minute and seconds sections. Refer to Auto Restart mode below for more information.

## Source

Tap to cycle through the timecode modes:

## HDMI

### HDMI/SDI embedded Timecode:

With this setting, the HDMI/SDI input will use the Timecode embedded in the input signal. The controls to adjust Timecode values are disabled in this menu as you will need to adjust these on the camera. Note that not all HDMI/SDI sources embed Timecode.

### Trigger from HDMI Timecode:

If HDMI timecode is selected and the camera is in REC RUN mode, the user has the choice to start and stop recording remotely from the source camera timecode.

To enable rolling Timecode Start/Stop functions, simply set the HDMI Timecode switch to on. When enabled, pressing the camera Record Stop/ Start button will make the NINJA V start and stop recording simultaneously as the timecode starts and stops.



*When using the camera in Free Run timecode, the rolling timecode trigger might not work as expected.*



*Note that whilst camera triggers are also looped out on HDMI not all wireless systems carry the trigger on to other devices so it's worth testing your system before a shoot if you plan to use it in this way to record proxies.*

## Time of Day

With this setting, each new clip that is created will contain embedded Timecode starting with the time of day when the recording is started. Please check that NINJA V clock has been set correctly. This can be set in the "Date Menu" on page 220



*If recording is stopped and then restarted while in this mode, there will be a time gap between the last clip and the next one, equal to the length of time the NINJA V has been out of record.*



*In Time of Day mode, the controls on the Timecode Setup Screen for adjusting the start-point of the Ninja's Timecode are not available, as the Timecode is set by the Ninja's internal clock.*

### **Record Run**

With this setting you set the starting timecode for the first clip. The following clips will start at the frame immediately after the out point of the preceding clip. This will continue for all clips that follow. This is also known as continuous Timecode.

### **Auto Restart**

With this setting, the Timecode will reset to the timecode you have defined whenever you press record. All your clips start with this same timecode. Use the - and + icons above each unit to adjust the numerical values for the hour, minute and seconds sections.

### **AtomX SYNC**

This setting will be available when you have an AtomX SYNC module connected to your NINJA V. For more information refer to the AtomX SYNC Expansion Module section.

### **Atomos CONNECT**

This setting will be available when you have an Atomos CONNECT attached to your NINJA V. For more information refer to the "ATOMOS CONNECT" on page 57 section.

## **Use Drop Frame**

Allows you to use drop frame timecode type.

## **HDMI Out Timecode**

Allows you to output the timecode chosen here on the HDMI Output of the Ninja.





*Additional settings will appear when you have an AtomX SYNC module connected to your NINJA V. For more information refer to the AtomX SYNC Expansion Module section.*

## Timecode Menu - Wireless Timecode & Sync

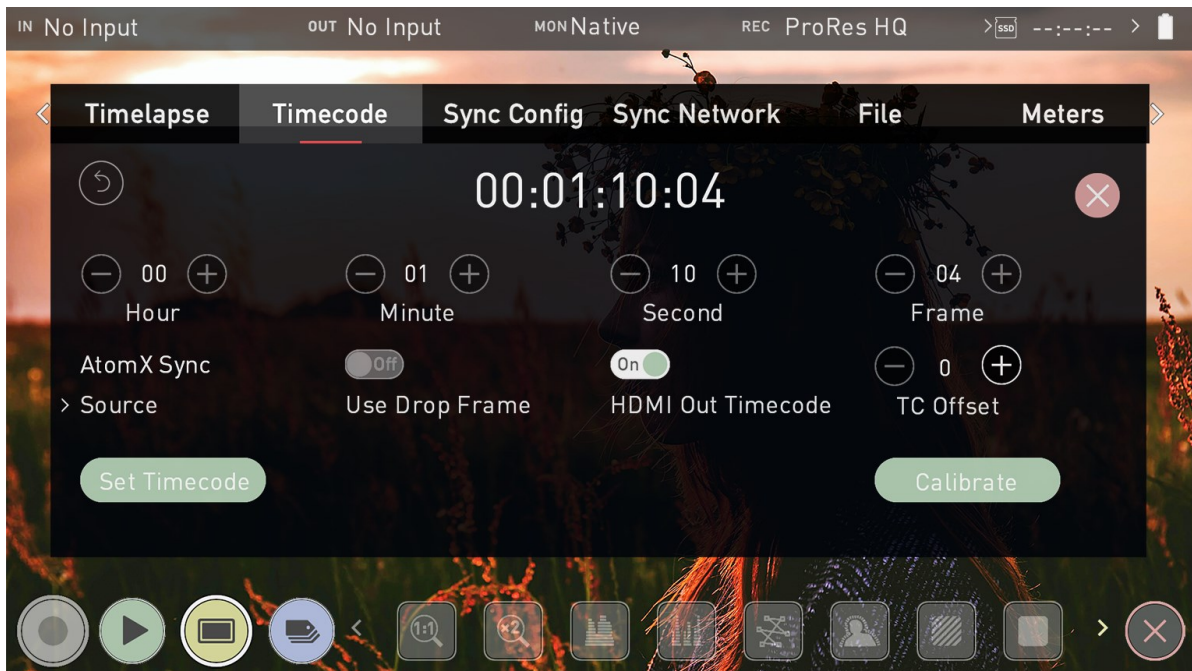

By attaching an optional AtomX SYNC module or Atomos CONNECT to your NINJA V, you can take advantage of ATOMOS AirGlu™ wireless sync technology to simplify your multi-camera productions. These accessories allow for wireless timecode synchronization with other Atomos devices, cameras, audio recorders and timecode systems on set.



*To use the ATOMOS CONNECT with your NINJA V, ensure you have AtomOS firmware version 10.8 installed. Visit [atomos.com/support](https://atomos.com/support) to download firmware for your device.*

The AtomX SYNC module also has a small battery inside it which acts as a hot swap continuous power battery extender, allowing you to keep your NINJA V running for approximately 5 minutes while you change the main battery. For more information refer to the AtomX SYNC Expansion Module section.



*To use the AtomX SYNC Module with your NINJA V, firmware version 10.4 or later needs to be installed.*

## Region Selection

The first time you power on your NINJA V with an AtomX SYNC module or Atomos CONNECT attached, you will be prompted to select a region. It is important to select the correct geographical region here as these accessories adhere to strict guidelines for each region.

## TC Offset

Allows you to set a timecode offset value to account for audio delay when using the AtomX SYNC module or Atomos CONNECT. Use the - and + icons to manually adjust the amount of frames to delay. Where the Calibrate function has been used, the frame delay will be displayed here. For more information refer to the AtomX SYNC Expansion Module section.

## Set Timecode

When AtomX SYNC or or Atomos CONNECT is selected as the source, Press the Set Timecode button to open the Sync Network Timecode page. In this menu you can use the Set From setting to select the timecode to use as the clock for the Server unit.

### Set From

Tap to cycle through the options:

**Time of Day:** Each new clip that is created will contain embedded Timecode starting with the time of day when the recording is started. Please check that NINJA V clock has been set correctly. This can be set in the "Date Menu" on page 220

**Manual:** With this setting, the Timecode will reset to the timecode you have defined whenever you press record. All your clips start with this same Timecode. Use the - and + icons above each unit to adjust the numerical values for the hour, minute and seconds sections. TBC

## Calibrate

Before using the AtomX SYNC module or Atomos CONNECT, it is important to use the calibration feature. HDMI cameras deliver their video and audio to your NINJA V with a small delay, so calibration is necessary to identify the amount of delay that your camera has and take that into account. This will ensure that your video, audio and timecode are in sync, especially if you plan to use SYNC expansion modules or or Atomos CONNECT accessories with multiple NINJA V's on a multicamera shoot.

## How to sync your video, audio and timecode

Follow these steps to sync your video, audio and timecode - and repeat for each NINJA and SYNC module that is connected to a camera.

1. Navigate to the Timecode menu on your NINJA V.
2. Select AtomX Sync or or Atomos CONNECT as the timecode source. The following screen will appear.

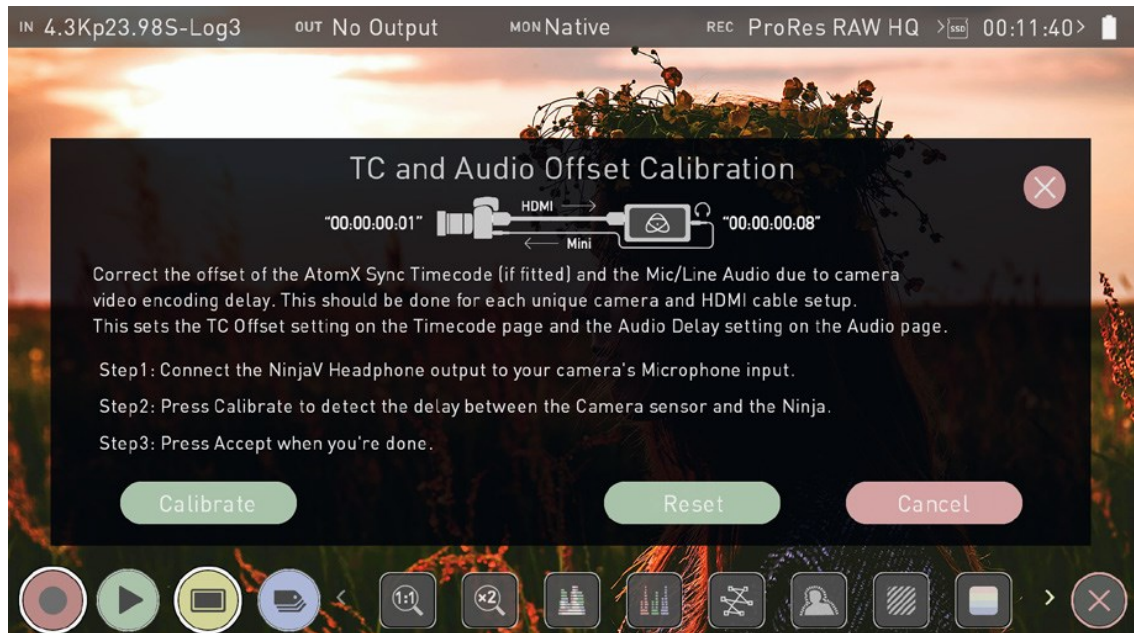

3. Using an HDMI cable, connect the HDMI output of your camera to the HDMI in connector on your NINJA V.
4. Using an AUX cable, connect the headphone Out of your NINJA V to the mic/line in connector on the camera and press Calibrate.

Your NINJA V calculates frame delays & displays it as shown below.

Tap ACCEPT to select the calibrated frame delay. The frame delay will be listed at TC Offset on the Timecode menu page.

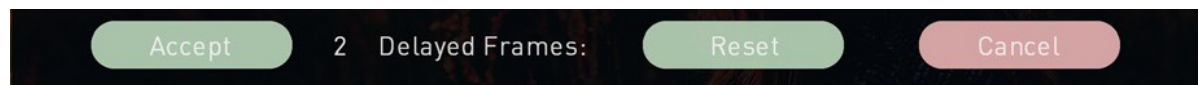



*If you see 'No Audio Detected' on your NINJA V, check the audio settings on your camera and tap 'retry'.*



*It's important to recalibrate every time that you change camera type, frame rate or resolution.*

# Sync Config Menu



## TIMECODE SYNC

This page allows you to define a network role for each NINJA on the network as either Server or Client, so that Client units can connect to the timecode network created by the Server unit. It also allows you to add other devices like audio recorders to the network via Bluetooth. The settings that appear on this menu page will vary, depending on the network role of the NINJA V. Some settings will only appear when your NINJA V is set to Server mode, whilst others will only appear when it is set to Client mode. See Network role below for more information.



*The AirGlu RF - SYNC network menu may not display connected AirGlu devices when using the ATOMOS CONNECT, but the client devices will receive Timecode and display a SYNC Network ID.*

## Network Role

Tap to cycle between the options to set the network role for the NINJA V as either Server or Client. The 'Server' unit will then provide the timecode source for all 'Client' units on the network. For any other NINJA that you want to sync with, 'Client' should be selected as the Network Role on it's Sync Config page. This allows the Client units to connect to the timecode network created by the Server unit.

## **Start Network**

Once you have finished setting up your Server unit, tap Start Network to toggle the Sync network on and off. Note that on Client units you will have a Join Network switch instead of Start Network.

## **Join Network**

When this setting is 'on', the client unit will connect to the Sync Network created by the Server unit. Tap to toggle on and off.

## **RF Channel**

Use the '-' and '+' to select an RF channel between 1-12. Changing the RF channel can help in situations where you are experiencing interference from other devices. Ensure that the RF channel on any Client units is set to the same RF channel as the Server unit.

## **Record Control**

When this setting is enabled, tapping record on the Server Unit NINJA V will cause any other NINJA V or GoPro on the network to start recording as well.

## **Network FPS**

On Client units, Network FPS will be displayed and the frame rate will match the frame rate of the server unit.

## **Signal**

Provides information on the signal strength.

## **Network ID**

Provides information on the Network.

## **Region**

Tap to cycle through the options until you find your region and tap 'confirm' to accept the new region or 'cancel'.

## Set Timecode

Press the Set Timecode button to open the Sync Network Timecode page.

## Input

Tap to cycle through 'Time of Day', 'Manual' and 'Input'. Select 'INPUT' and tap 'Set Timecode'. TBC

## Set Device Name

Tap to change the name of your NINJA V unit. For more information refer to Unit Name in the "Best Practice" on page 19 section.

## BLUETOOTH

You can pair with up to six Bluetooth devices, like an iPhone or a Zoom F6 audio recorder, so that they can connect to the timecode network. By connecting an ATOMOS Ultra Sync Blue to the timecode network, you can pair it with Bluetooth devices that are much further away from the AtomX SYNC module. For more information, see [atomos.com/accessories](https://atomos.com/accessories)



*AirGlu Bluetooth is currently not enabled when using ATOMOS CONNECT, and devices cannot be paired to receive Bluetooth.*

## Pair

Follow the manufacturers instructions for each device to set it up for Bluetooth pairing, then Tap Pair to connect to the device. Once paired, the device will be listed in the "Sync Network Menu" on page 209 page, along with the other connected NINJA V's and other devices. For information on pairing with an iOS device or Mac computer for use with the AtomRemote app, refer to the "Connecting to AtomRemote" on page 236 section.

## Unpair All

Tap to unpair all devices that are connected to the timecode network.



## Free Pairs Available

The numerical figure indicates the number of Free Pairs that are available for Bluetooth pairing.



*For connected Client units, the timecode source should be set to AtomX Sync on the Timecode page when using the AtomX SYNC Module or AirGlu when using the ATOMOS CONNECT module.*



*Multiple NINJA units can be added to the timecode network. Simply repeat this process on each unit.*

# Sync Network Menu



The Sync Network menu page displays all of the devices that you have added to the timecode network. The columns in the table will list the details for each connected device in the sync network.

iOS applications like [UltraSync Blue Slate](#), [Apogee Metarecorder](#), [Mavis Pro Camera](#) and [MovieSlate8Pro](#) that are running on a device that is paired via Bluetooth will also be listed here.

With the use of sync products from Timecode Systems, you can also synchronize with a number of other devices like cameras and audio recorders. For more information, watch the [AtomX SYNC module video](#) on ATOMOS Academy.



*The AirGlu RF - SYNC network menu may not display connected AirGlu devices when using the ATOMOS Connect, but the client devices will receive Timecode and display a SYNC Network ID.*



*AirGlu Bluetooth is currently not enabled when using ATOMOS CONNECT, and devices cannot be paired to receive Bluetooth.*

# File Menu



This menu allows you to change the unit name for your NINJA V. It also gives you the ability to dictate the scene and shot number that will be recorded.

## Unit Name

Creating a unique name for each NINJA V you are using can be very useful when using multiple devices or with multicam shoots.

The unit name serves two main purposes:

- **Drive Naming:** Giving the unit a unique name aids with identification. Once you have given it a name all drives subsequently formatted in the NINJA V will bear this name as a prefix. By default, the unit will be named **NINJAV**
- **File Naming:** The current unit name appears at the start of the recorded clip name: **NINJAV\_S001\_S001\_T001**

< >:

Use the arrow icons to select a letter in the current unit name. The selected letter will appear at the Letter setting.

## Letter

- / +:

Use these icons to move forward or backwards through the letters of the alphabet. Doing so will update the letter you selected with the arrows in the Unit Name setting.

## Scene

Allows you to adjust the Scene number that will form part of the recorded clip filename:  
NINJAV\_**S001**\_S001\_T001

- / +:

Use these icons to increase or decrease the numerical value for the Scene number up to 999. The value you select will be shown in the file name at the top of the screen during recording,

## Shot

Allows you to adjust the Shot number that will form part of the recorded clip filename:  
NINJAV\_S001\_**S001**\_T001

- / +:

Use these icons to increase or decrease the numerical value for the Shot number.

## Take

Takes that form part of the filename are automated: NINJAV\_S001\_S001\_**T001**

## Format

Tap to cycle through the file naming format options:

- **Scene/shot/take:** Allows you to accurately name planned shots as if you were using a conventional slate.
- **Rolling scene/shot/take:** Adds the ability to maintain continuous rolling file naming and take counts after re-formatting a drive.
- **Red/Arri:** Selecting this option will allow your recordings to use the same name as the files recorded in camera.



*Red/ Arri file naming is only supported when the signal is connected via SDI to the AtomX SDI Module or the ATOMOS CONNECT accessory. For more information refer to the "Input via AtomX SDI Expansion Module" on page 91 section and "ATOMOS CONNECT" on page 57 sections.*

# Audio Menu

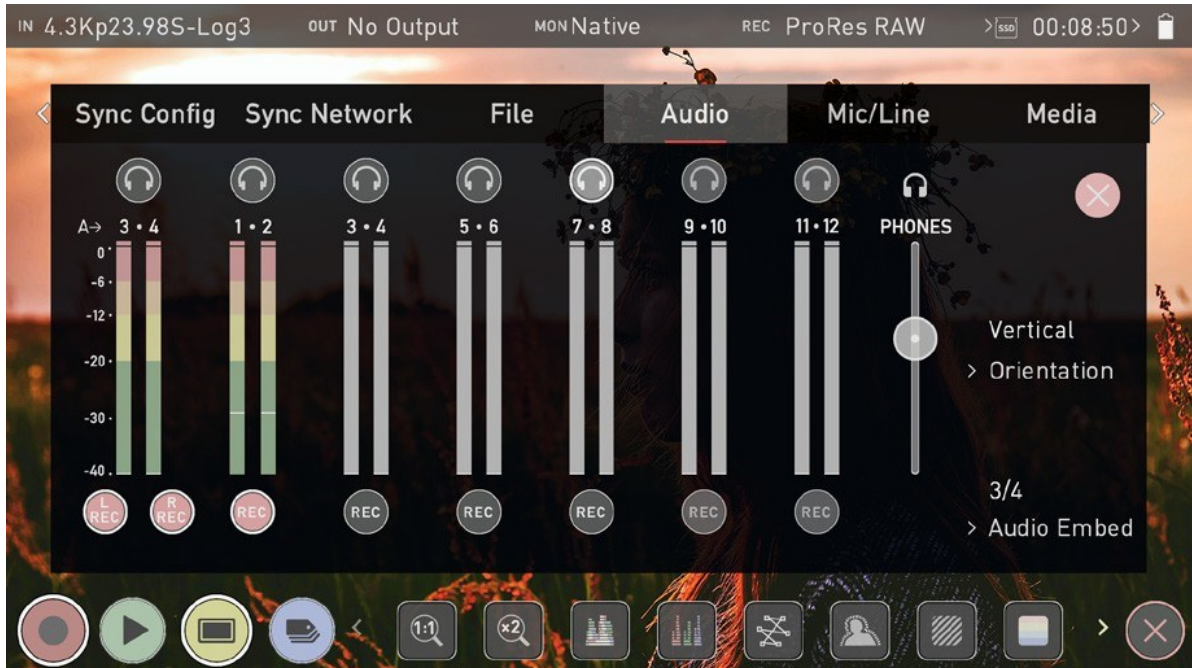

In addition to selecting the Audio tab from the menu tabs across the top of the screen, you can also access the Audio menu by tapping the audio meters (shown below) on the record, monitor and playback home screens.

## Audio Meters

The audio meters display the audio levels for all active audio channels. This allows you to monitor all channels visually.

## Headphone icons



To monitor the audio, tap the headphone icon next to the channel you wish to monitor from the headphone output. Only one channel (stereo pair) may be monitored at any time using headphones connected to the 3.5 mm headphone jack on your NINJA V.



Selecting the Monitor icon does not mean that track is selected to be recorded. You need to select each channel using the record button. Tracks that are selected to be recorded have colored Audio Meters. See image above.

## REC icons

These icons allow you to select the channels of audio to record. Tap the record button for each channel that you want to record and it will turn red to indicate the fact that it is being recorded. You can record multiple channels of audio by tapping multiple REC buttons.

## Orientation

Allows you to select the orientation for audio meters on the NINJA V display. Tap to cycle through the options:

- **Horizontal:** Displays the 2 channels you are actively monitoring.



- **Vertical:** Displays 8 channels + 2 analog Channels.

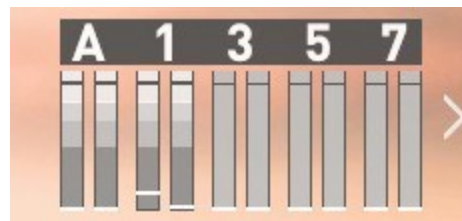

## Audio Embed

Allows you to embed the analog audio channels into the digital signal, so that when you output the video signal over HDMI/SDI this audio is also output as part of the digital signal. The available options will depend on how many channels of audio are coming in. Tap to cycle through the options.



*When using the AtomX SDI Expansion module, your NINJA V can record 12 embedded audio channels, instead of the usual 8 channels of audio when using HDMI.*



*If analog audio is recorded it will be placed as track 1-2 with embedded audio moving to 3-4. Note if analog channels are turned on but no audio is present, in many video players you will not hear silence as they often just play the first stereo pair. In an NLE you can easily access all the recorded tracks.*



# Mic/Line Menu

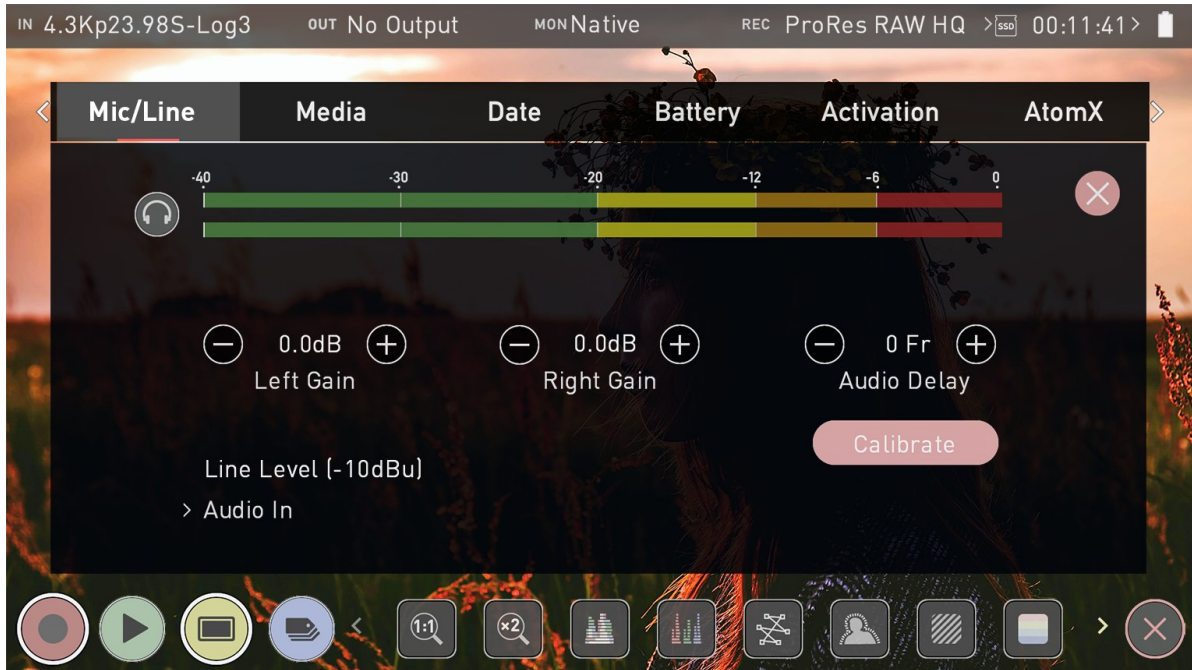

This menu page provides settings for analog audio that is connected

## Analog Audio Meters

These meters display the audio levels for the left and right channels of analog audio.

## Headphone icon

Tap the headphone icon to monitor the analog audio from the 3.5 mm headphone output on your NINJA V. For more information on meters and monitoring, refer to the "Audio Menu" on page 213 section.

## Left Gain / Right Gain

- / +:

Use these icons to adjust the gain applied to the left and right analog audio channels. Once you have selected the input line level that matches your input at Audio In, analog gain can then be tuned by incremental increase or decrease of up to +/- 20dB individually for both left and right channels.

## Audio Delay

- / +:

Use these icons to adjust the audio delay by whole frames. This option allows you to delay the analog audio with respect to the digital audio so that it is in sync with your video source.

## Audio In

Tap on Audio In to select the input line level that matches your input type.

Options available are:

- **Mic Level (-40 dBu):** Sets the analog input channel to Mic Level via the 3.5 mm audio jack. Typically used when connecting microphones.
- **Line Level (-10 dBu):** Sets the analog input channel to Line Level via the 3.5 mm audio jack. Typically used when connecting most other audio devices to your NINJA V.



*It is not possible to vary the gain if the signal input is from the HDMI connection because this is digital and is embedded in the signal. You can usually adjust this from the camera, please see your camera manual for operational details.*



*NINJA V Mic input supports dynamic and powered microphones only. When using these, audio must be set as Mic Level*

## Calibrate

Allows you to measure the HDMI video delay from a camera and delay the analog audio input to sync with the incoming video signal. For more information refer to "Timecode Menu - Wireless Timecode & Sync" on page 201

# Media Menu



## MEDIA INFO

### Brand

Displays the brand and other information like model number for inserted media. Information about compatible media is available at: [atomos.com/compatible-drives](https://atomos.com/compatible-drives)



*If you do not see your media information, there may be a problem with the connection or drive. Try removing the drive and reattaching the drive. Ensure correct alignment of your media.*

### Capacity

Displays the total capacity of inserted media.

## Format

Tap to format the media inserted in your NINJA V. A confirmation screen will ask you to confirm that you want to format the media, and gives you an option to cancel if you pressed the button by mistake. Make sure your drive is correctly inserted and all data from previous shoots has been securely backed-up.



*The NINJA V uses the exFAT file system for broadest compatibility across MacOS and Windows.*



*When you first insert a drive you may be presented with 'Invalid media'. This means that the drive has not yet been formatted and you simply need to format your drive before using it.*

## Secure Erase Format

For drives that carry the ATOMOS Logo such as the G-Technology 4K SSD, Angelbird 4KRAW, AtomX SSDmini by Angelbird and Sony, an option for Secure Erase is presented. This allows for the entire drive including the drive cache to be formatted. This will erase ALL content on the drive meaning nothing can be recovered. The benefit of this is to optimize performance. It will wipe all data off the drive (which may also be useful as an additional security measure) and reset it back as close as possible to factory conditions.

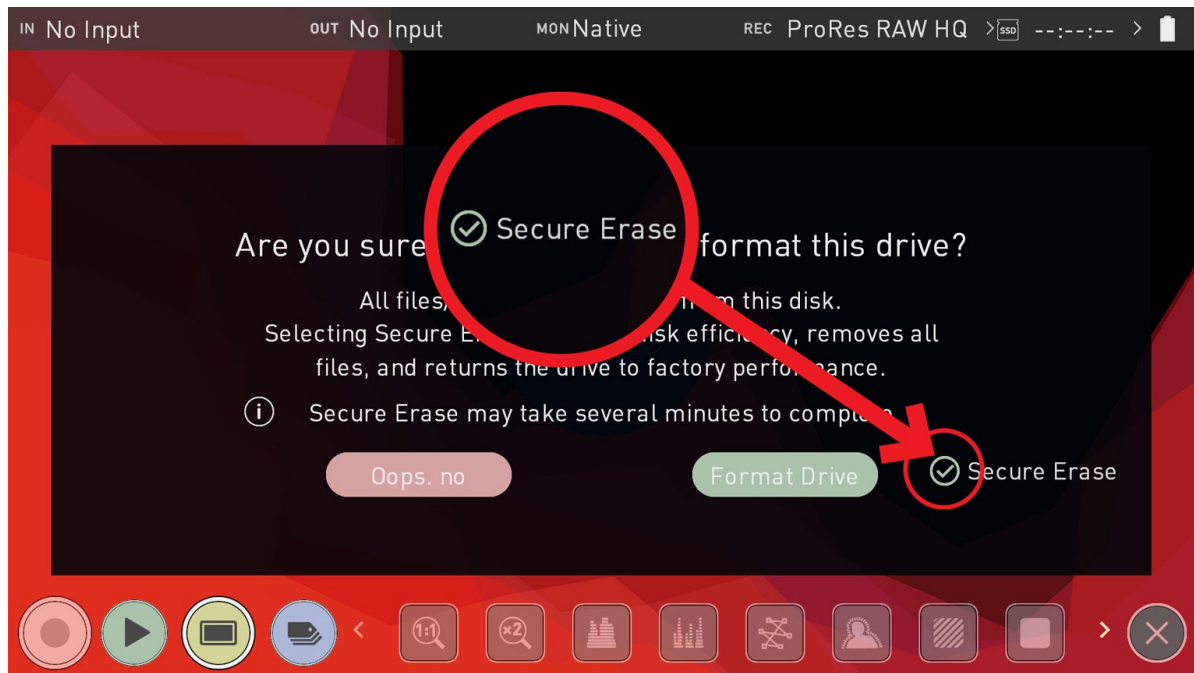

# Date Menu



## TIME

### Time Format

Tap to cycle between 12H and 24H time formats.

### Hour/Minute/Second

- / +:

Use these icons for each setting to set the time used on the NINJA V. This will also change the time of day Timecode.

## DATE

### Month/Day/Year

- / +:

Use these icons for each setting to set the date on the NINJA V.

# Power Menu



## Power Down

On the left of the screen is a power icon. Tap and hold this button for 4 seconds to perform a software shut down of the unit.

## Tap to Lock/Unlock

This image provides information on how to lock and unlock the display of your NINJA V.

## Battery

### Using Batteries

The Battery icon on the right of the Power menu screen indicates the remaining power in the attached battery. The numerical figure above the battery icon will indicate the remaining power in volts whilst the green shading inside the battery icon provides a visual indication of the current power level.

## Using the Battery Eliminator

When using the supplied Battery Eliminator, the remaining power indicator will remain green and show 100% full. The displayed voltage will be determined by the input source.

## Using the AtomX SYNC module

When you have an AtomX SYNC module attached to your NINJA V, a small battery icon with the word 'Sync' will be displayed. This battery icon indicates the remaining power of the module's internal battery.



*When a battery is running low the battery icon in the upper right corner of the screen will flash and warning menus will appear at 25% and 10%.*

## Cooling

These settings provide manual controls for the fan inside your NINJA V. This means that the fan can be set to a low speed, so that it's whisper quiet during a take and then boosted using Turbo mode to cool the system when it is no longer recording.

### Cooling Mode

Allows you to set the cooling mode. Tap to cycle through the options:

- **Low:** Approximately 20% quieter fan during recording, but the record duration may be limited.
- **Medium:** Approximately 10% quieter fan, while maintaining balance between lower fan noise and extended record duration.
- **Auto:** Uses default fan operation. Optimized for uninterrupted recording.



*While the fan modes will allow for quieter operation with shorter run times in ambient temperatures below 25 °C/77 °F, it is advisable that you conduct your own tests for the environmental conditions and rig setup.*

### **Turbo Cool (On/Off)**

Turning this mode on will enable boosted fan operation when the recording is stopped. Using this in combination with Low fan mode helps maintain a good balance with record durations. Tap the switch to toggle the Turbo Cool mode on or off.

### **Dim Display (On/Off)**

Enabling this will dim the display brightness during takes to help with cooling. It also helps maximize record times in Low fan mode. Tap to toggle the Dim Display mode on or off.



*Whilst using the Dim Display setting, the display brightness controller will allow for temporary adjustments in the screen's brightness but will default back to the level set by Dim Display options (approx 30%).*



*When your Ninja gets close to peak operating temperature, record times may be reduced, and fan speeds will increase. Using a combination of Low fan mode with Turbo Fan and Dim Display gives you the best balance of continuous record time and quiet operation.*



# Activation Menu

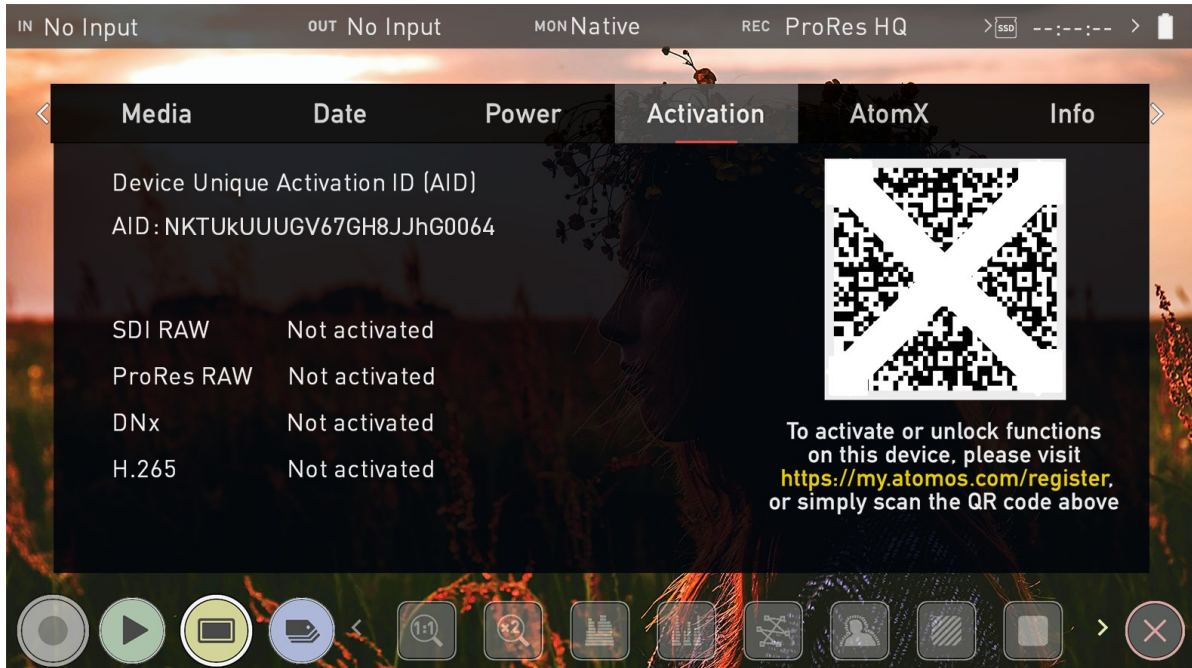

The Activation page allows you to activate the Apple ProRes RAW, Avid DNx and H.265 codecs, and other features like SDI RAW on your NINJA V.



*If you don't see the Activation menu tab, you will need to update your NINJA V to firmware version 10.6 or above.*



*If you have previously activated these codecs, you do NOT need to activate these codecs again.*

## Activating Codecs and Features

To activate codecs or features, use the camera on your smartphone to scan the QR code on the Activation page. Tap on the notification that appears, and you will be taken to [my.atomos.com](https://my.atomos.com) in your browser.

## my.atomos.com

The my.atomos.com site allows you to manage all of your ATOMOS devices in one place. By registering your products, you can then activate codecs and features, download user manuals and firmware updates. Registration also extends your warranty from 1 to 3 years from the date of purchase. For more information on my.atomos.com refer to [atomos.zendesk.com/hc/en-us/articles/5133805061007-Using-my-atomos-com](https://atomos.zendesk.com/hc/en-us/articles/5133805061007-Using-my-atomos-com)

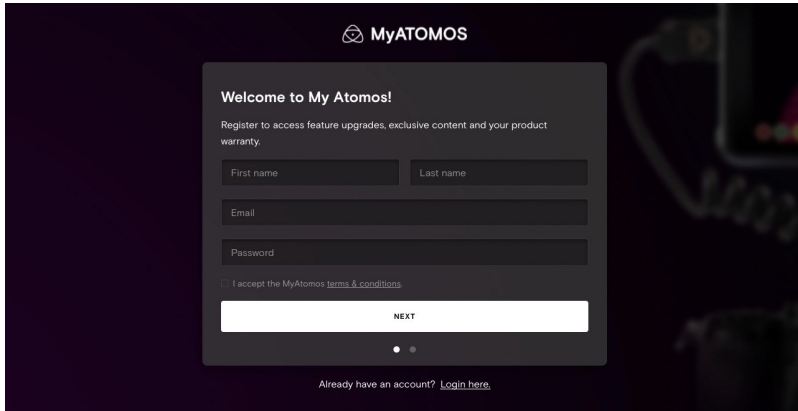

After scanning the QR code, [my.atomos.com](https://my.atomos.com) will open in your browser. You will be prompted to register as a new user, or login if you are an existing user to your [my.atomos.com](https://my.atomos.com) account. Once you have logged into your account, the 'Register a Device' page will open and the following fields will already be pre-filled:

- Product name
- Activation ID (AID) (located in the Activation Menu tab on your NINJA V)
- Device ID (DID) (located in the Info Menu tab on your NINJA V)

Complete the following fields:

- Serial Number (located in the battery slot)



*Enter the serial number exactly as shown, and ensure that all letters and numbers are entered correctly. Take extra care to ensure that 0 (zero) and O (the letter O) are not confused for one another.*

- Purchase Date
- Reseller (where you purchased your NINJA V)

Then tap on Submit to open the 'My Atomos Devices' page.

# My Atomos Devices Page

The My Atomos Devices page lists all of your registered ATOMOS products.

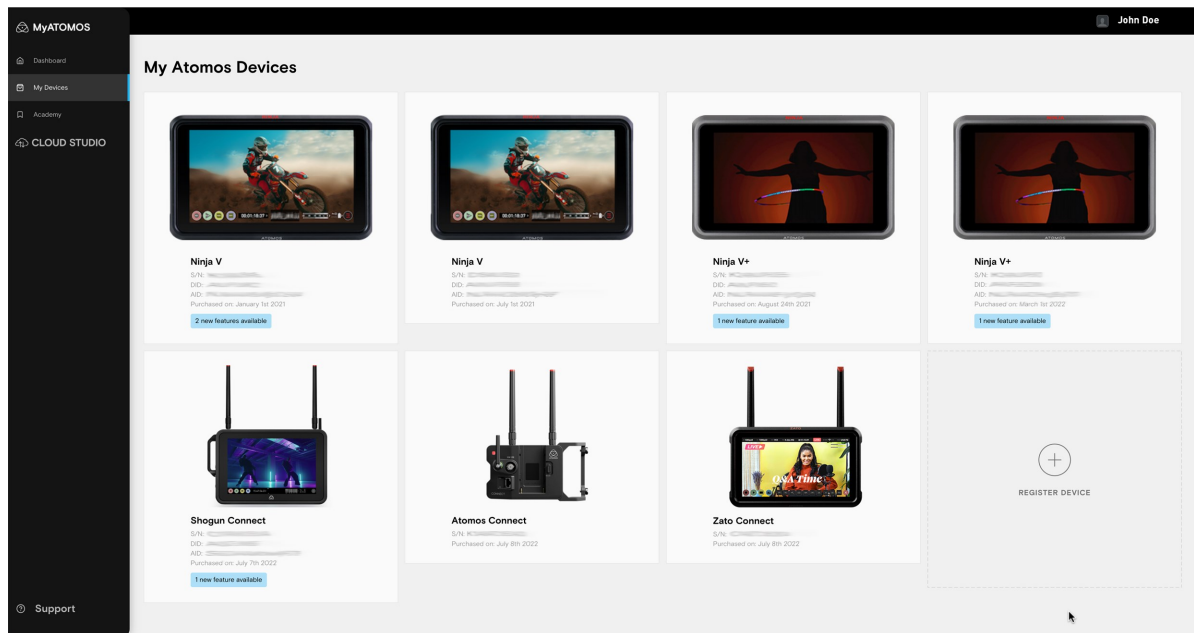

Tap on the NINJA V image to open the device page, where you can view the information and upgrade options for your NINJA V. The Features tab displays the codecs and other features that can be activated for your NINJA V, as well as those that are already activated. The Firmware Updates, Product Manuals and Connect tabs provide additional support that is specific to your device.

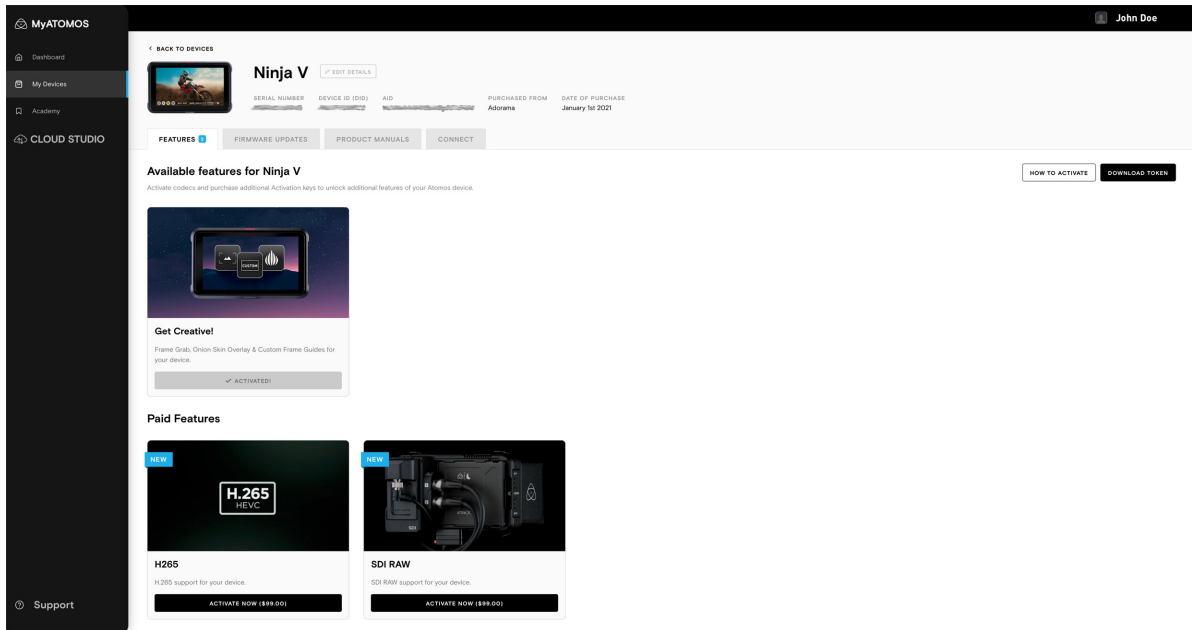

## Activating codecs or features on the Activation Tab

On the Features tab, click to activate your chosen codec/s or features and create an activation token. This can then be downloaded from the [my.atomos.com](https://my.atomos.com) page and will also be emailed to your registered email address.

On the Features tab, click the Activate Now button on the codecs or features you want to activate. Once you have selected all the codecs and features that you want to activate, click on Download Token in the top right corner. A token containing activations for the selected codecs and features will then be downloaded, so that you can load it onto your device. The token will also be emailed to your registered email address.

The token will download as a .zip folder, so you will need to unzip the folder to access the files inside. On a Mac, simply double click on the zip file to unzip it.

Place the activation.bin file on the ROOT of your media and insert the media into your NINJA V. The token file will be detected and automatically open the activation page, allowing you to install the codec/s.



This method allows you to activate both codecs and add other activation keys, which will unlock further features on your device.



*A single activation token will support all functions unlocked on your device via [my.atomos.com](https://my.atomos.com).*



*The activation token will remain in your account on [my.atomos.com](https://my.atomos.com) and also be emailed to your registered address.*

## Manually registering devices and activating codecs and features

If you prefer, you can manually register products and activate codecs at [my.atomos.com](https://my.atomos.com) instead of scanning the QR code.

Navigate to [my.atomos.com](https://my.atomos.com). You will be prompted to register as a new user, or login if you are an existing user to your [my.atomos.com](https://my.atomos.com) account. Then select My Atomos Devices from the left hand navigation pane and click Register Device.

Once the Register a Device screen opens, select NINJA V from the drop-down menu under the Product Name field.

Complete the following fields:

- Serial Number (located in the battery slot)
- Device ID (DID) (located in the Info Menu tab on your NINJA V)
- Purchase Date
- Reseller (where you purchased your NINJA V)

Navigate to the Activation menu page on your NINJA V and use the Activation ID (AID) on that page to complete the Activation field. Tap on Submit to open the 'My Atomos Devices' page.

Once on the 'My Atomos Devices' page, follow the steps listed above at 'Activating codecs or features on the Activation Tab'.

# AtomX Menu

The AtomX menu page indicates the attached AtomX Expansion Modules and their versions. If you have successfully upgraded your firmware and attached an AtomX Expansion Module, you will see a screen similar to the image below. This indicates the fact that your firmware is up to date and that the attached module(s) are ready for use.



## Attaching Modules

### To connect an AtomX Expansion Module to your NINJA V:

1. Line up the rear part of the expansion module with the AtomXpansion port of NINJA V.
2. Gently slide the module into the AtomXpansion port until it clicks into place.



*When a module is mounted, make sure that it clicks into place.*

### To remove an AtomX Expansion Module from your NINJA V:

1. Press the battery release button on the NINJA V
2. Gently slide the module upwards and away from the NINJA V.

## Attaching batteries to an AtomX Expansion Module

Most AtomX Expansion Modules have a battery slot onto which you can connect a compatible NP-F L Series type battery or ATOMOS Battery Eliminator. The battery latch on AtomX Expansion Modules will lock the battery or Battery Eliminator into place.

AtomX CAST does not have a battery slot and can only be powered by the 12V-3A AC power supply that was included with your NINJA V. For more information refer to the "Powering the AtomX CAST" on page 267 section.

### To attach a battery to an AtomX Expansion Module

- Gently slide the battery into the battery slot until it clicks into position

### To remove a battery from an AtomX Expansion Module

Slide the latch away from the battery and slide the battery upwards to remove it.

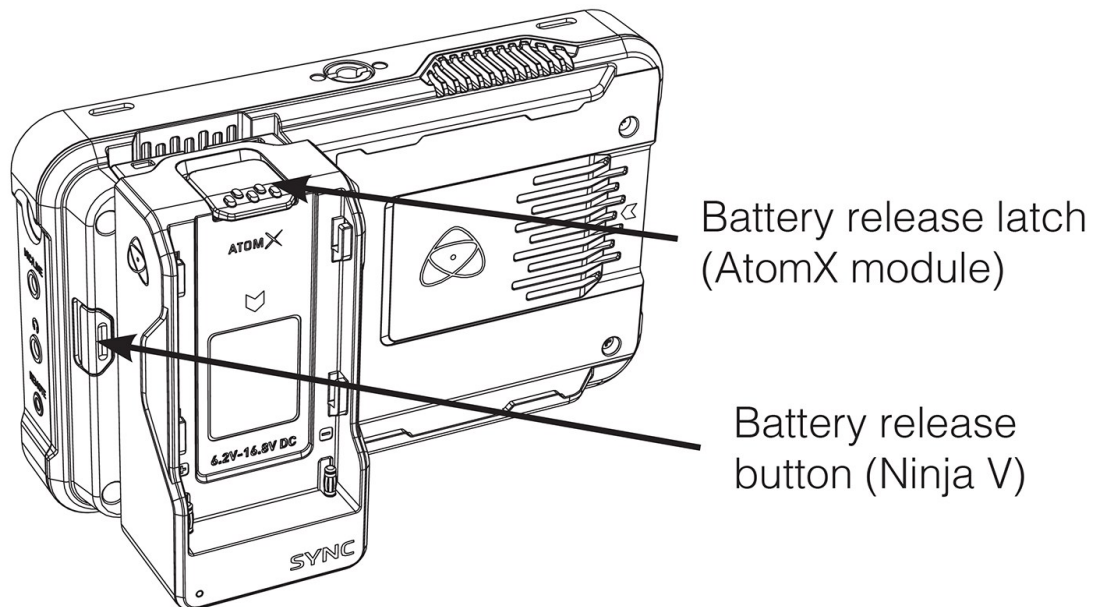

## Stacking Modules

Most AtomX Expansion Modules also allow for stacking on top of one another. This allows you to take advantage of the features of multiple modules at the same time.



The AtomX menu will display the attached modules and the stacking order. Specifically, the modules will be labeled on screen to indicate which one is the Base Module and which is the Top Module.

To update firmware of a module, attach the module directly to the NINJA V and power it up.



*If a module is at the top of a stack, then it will not update.*



*When stacking AtomX modules, ensure that the AtomX SDI module is the BASE MODULE and the AtomX SYNC module is the TOP MODULE. It is not physically possible to stack another module on top of the SYNC module.*



*You cannot have an AtomX SDI Expansion Module stacked on top of another AtomX SDI Expansion Module.*



*Modules cannot be attached to an Atomos CONNECT*

# Info Menu

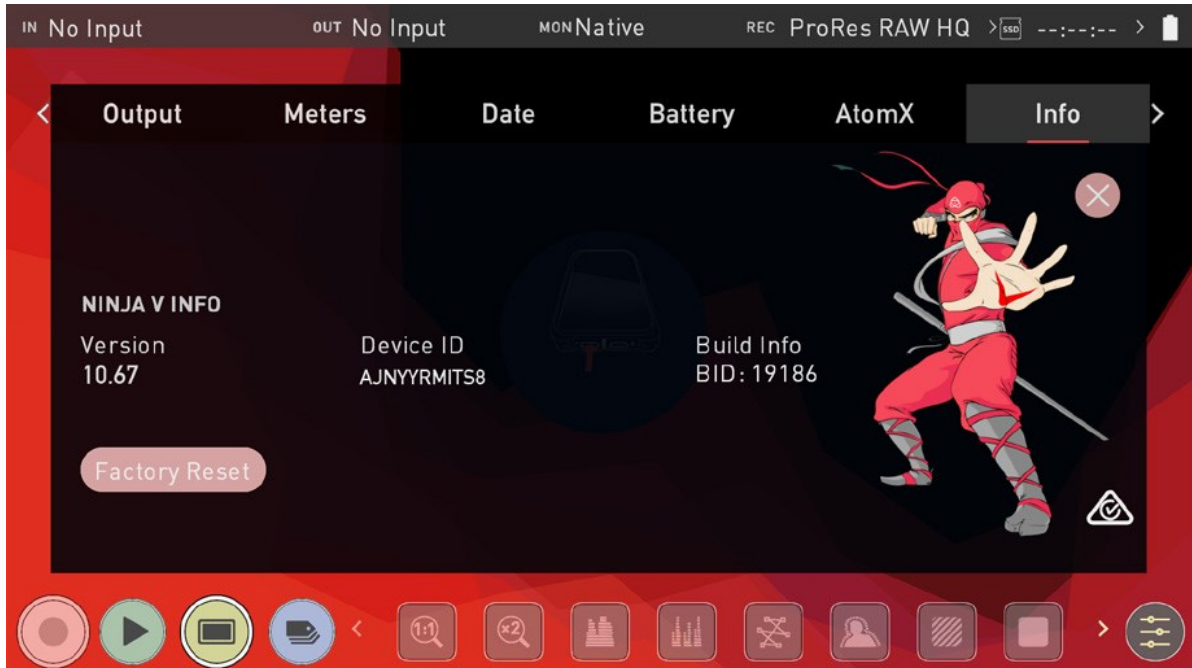

## NINJA V INFO

Shows the software (firmware) version and unique device ID (DID) of your NINJA V device. This will be required to activate additional codecs and features. For more information refer to the "Activation Menu" on page 224 section. You can also check on the ATOMOS website to ensure you are running the latest firmware: [www.atom-os.com/support](http://www.atom-os.com/support)

## Factory Reset

Allows you to revert your NINJA V to it's factory condition. All user settings will be lost.



*Before performing a factory reset, ensure that you have unpaired your device from the cloud*

### **3rd-Party license**

Downloads third party licensing documents for software used on your NINJA V to the attached disk.

## The AtomRemote App

With the AtomX SYNC module attached, you can use the AtomRemote app to wirelessly control your NINJA V over Bluetooth from a compatible iOS device or a Mac.

The AtomRemote app allows you to remotely control recording and playback, and perform a range of configuration tasks and operations wirelessly up to 15 meters via Bluetooth LE. Input options include the ability to define how the device connects to the camera, select Gamma/EOTF and adjust Gamut settings.

For monitoring, AtomRemote can be used to control playback, select monitoring modes and apply custom 3D LUTs. On-screen tools such as focus peaking, 1:1 zoom, frame guides and waveforms can also be activated. Output controls provide options for 4K to HD down scaling, LUT preview and HDR output. You can also view the status of attached batteries and the remaining recording time of inserted media and adjust many other settings.

Remote access is ideal for situations where it is difficult or unsafe to access your camera and NINJA V setup. For example, where the setup is mounted on the ceiling or on a crane, as part of a crash cam setup or on a gimbal or stabilizer, you can adjust settings and start recording from a distance without having to physically touch the unit.



*To control the NINJA V via the AtomRemote app, an AtomX SYNC Module and an Apple iOS device running iOS 12 or later, or a Mac running macOS 10.15 (Catalina) or later is required.*



*AirGlu Bluetooth Remote control via the Atom Remote App is currently not supported when using ATOMOS CONNECT.*

# Connecting to AtomRemote

## Installing the AtomRemote app

The iOS and Mac version of the app can be downloaded for free. You can either search for AtomRemote in the App Store or download the app through this links:

[apps.apple.com/app/atomremote/id1468547361](https://apps.apple.com/app/atomremote/id1468547361)



For a full list of all compatible iOS devices, refer to our [FAQ article](#).



*To control the NINJA V via the AtomRemote app, an AtomX SYNC Module and an Apple iOS device running iOS 12 or later, or a Mac running macOS 10.15 (Catalina) or later is required.*

## Setting up the AtomRemote app:

Before you start, ensure that Bluetooth is enabled on your device. AtomRemote uses Bluetooth LE to connect to the NINJA V, so there's no need to navigate through the Bluetooth menu in iOS. The following steps will get you up and running.

You can also watch the [AtomRemote setup guide](#) on our YouTube channel.



*AirGlu Bluetooth Remote control via the Atom Remote App is currently not supported when using ATOMOS CONNECT. This feature is coming soon.*

1. Attach the AtomX SYNC module to your NINJA V and attach a power source.
2. Power on your NINJA V
3. Open the AtomRemote app and choose Ninja as the device you want to control.



When you open the app for the first time, you need to grant permission for AtomRemote to use Bluetooth to communicate with ATOMOS devices. Tap OK in the pop-up dialog to confirm.

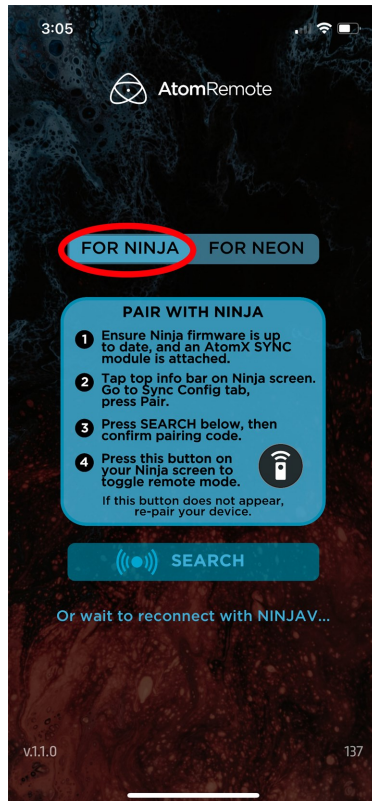

4. On the NINJA V, tap the top info bar and swipe across to the Sync Config menu. Tap on Pair in the Bluetooth section to enter Pairing Mode.



5. Compare the pairing ID on both your NINJA V and the AtomRemote app. If the code matches, tap Accept Code Above on the AtomRemote app to begin pairing.

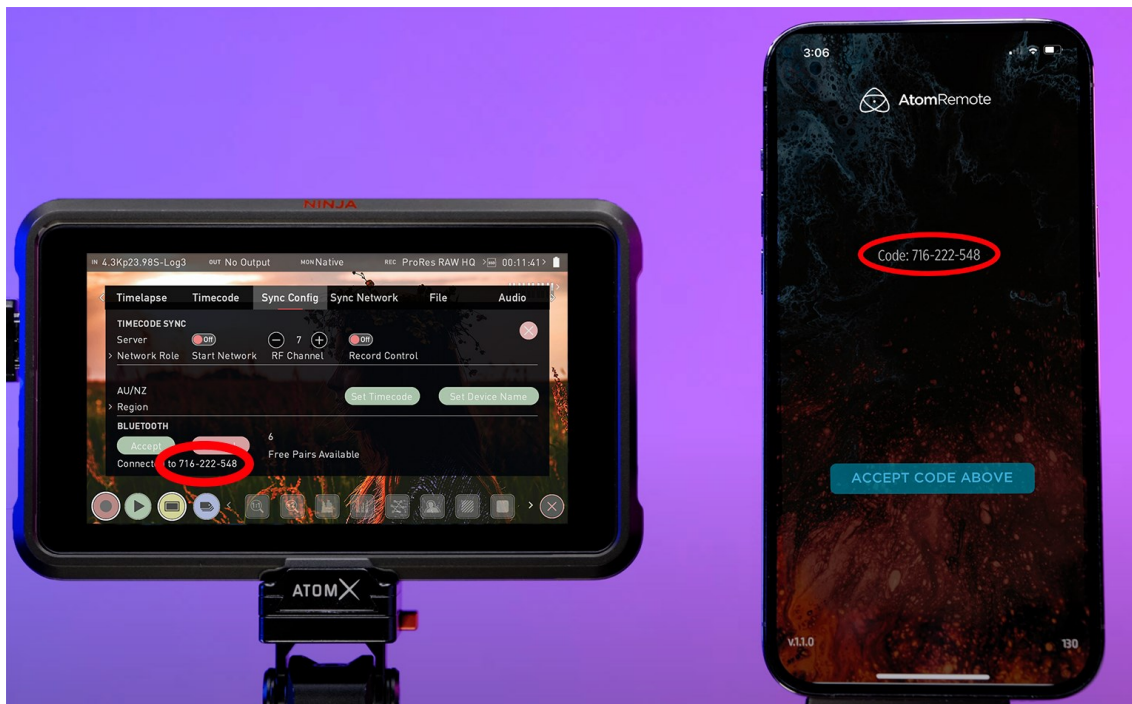

6. After successfully pairing the devices, a white Remote icon will appear on the display. Set the Ninja to Remote mode by tapping this icon. --



*If you don't set the Ninja to Remote mode after completing the pairing process, you may be able to pair the same iOS/macOS device multiple times with your Ninja. This results in the app flashing back and forth to the pairing screen.*



7. The remote icon will turn blue, to indicate the fact that the NINJA V is in remote mode. You can now control your NINJA V from the AtomRemote app. Tap this icon again to return to touchscreen control.





*If you accidentally pair your remote device multiple times with the same Ninja, we recommend using the "Unpair All" option within the Ninja's Sync Config menu. This will reset the Ninja's pairing to the default state and allows you to re-pair your remote device. But please only once this time.*

## AtomRemote Connection Icons on the NINJA V Screen



### **WHITE Remote Icon**

Tap the white Remote icon to enable remote mode so that you can control your NINJA V from the AtomRemote app. Whilst Remote mode is active, you can't operate the Ninja's touchscreen.



### **BLUE Remote Icon**

A blue Remote icon will be displayed when your NINJA V is in remote mode. Tap this icon again to return to touchscreen control.



*Whilst Remote mode is active, you can't operate the Ninja's touchscreen. Exit Remote mode by tapping the blue Remote button to take control of the NINJA V Via the touchscreen again.*

### **AtomRemote App Connection States**

The following connection states will be visible

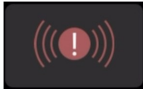

#### **RED (solid)**

No device connected

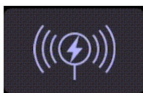

#### **BLUE (solid)**

Device connected and Remote mode active

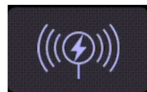
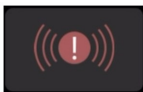

#### **BLUE with flashes of RED (alternating loop between red and blue)**

Device connected in the background, but Remote mode isn't active. Tap on the remote icon on screen to connect and set Remote mode to active.



*Rebooting your device will default to the last mode the Ninja was in before shutting down. If Remote mode was enabled, the Ninja boots into this mode when you power it back on.*

*Some of the features and settings cannot be accessed or adjusted by the AtomRemote app:*



- Adjusting fan control settings*
- Adjusting the AtomX SYNC module's wireless Timecode functionalities*
- Configuring the Time Lapse recording parameters*
- In Playback mode, the Playlist function*

# Using the AtomRemote app

The AtomRemote app can be used to adjust the settings on your NINJA V. It contains the usual menu options and icons from ATOMOS 10, so it will be familiar to ATOMOS users and will be an intuitive experience for anyone using an ATOMOS product for the first time.

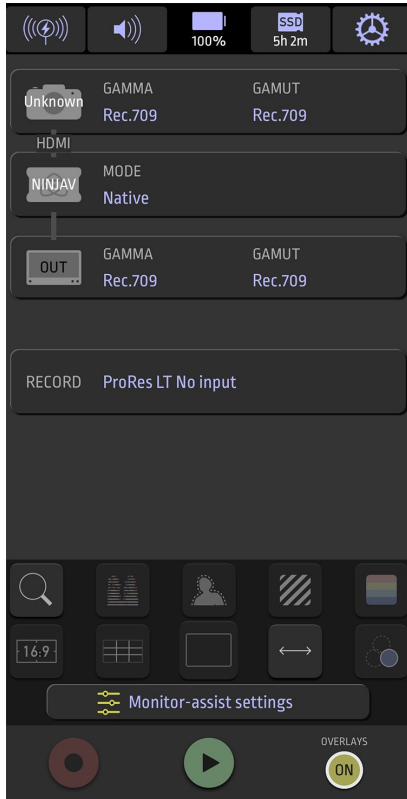

## Menu Tabs

The icons across the top of the app screen provide information and allow you to enter menus.



## Input, Monitor and Output

The central area of the app screen provides an overview of your mode, gamma and gamut settings.

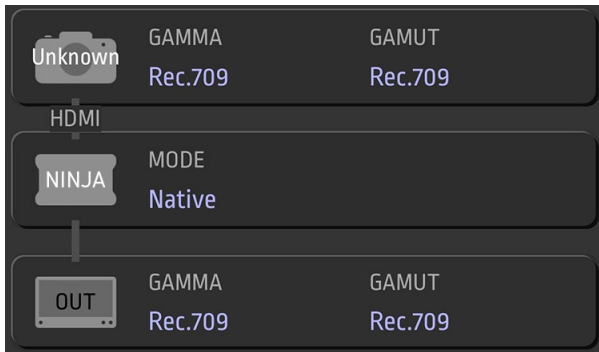

Tap on one of the boxes to open the Input, Monitor or Output Menu.

- Input (Connected camera or other source)
- Monitor (NINJA V) and
- Output (Connected external displays)

You can then swipe left or right on the screen to move between these menu pages.

## Record

The record settings indicate the recording resolution, codec and frame rate. Tap on this box to enter the Record menu to adjust the recording settings. For more information refer to the "AtomRemote - Record menu" on page 261 section.

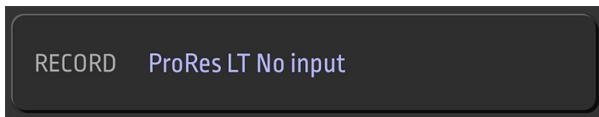

## Monitor Assist Tools

The standard ATOMOS monitoring tools occupy the lower region of the screen, along with the monitor-assist settings.

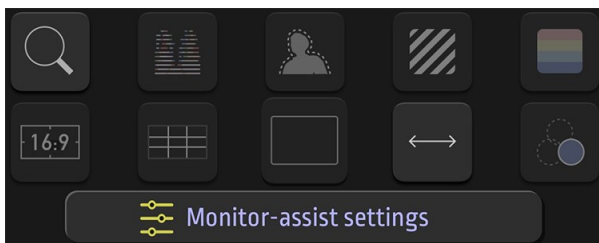

These tools can be toggled on and off simply by tapping the icon on the main screen of the app. When a tool is enabled, the icon will have a solid border around it. Tap the Monitor-assist settings button to access the Monitor Assist Settings page, which provides options and settings for each of the monitoring assist tools. For more information, refer to the "AtomRemote - Monitor Assist Settings" on page 263 section.

## Record, Play, Overlays

Along the bottom of the main screen are the Record, Playback and Overlays buttons. The Record and Playback buttons operate the same way that they do on your NINJA V. Tapping Record or Playback whilst in another mode, will switch NINJA V and the AtomRemote app into the selected mode. For more information refer to the "The Main Screen - Home Screen" on page 74 section.

You can turn off the overlays to view the image by itself, by tapping the Overlays button.

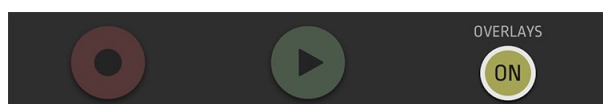

## Menu Tabs

Across the top of the app screen are icons for the following:

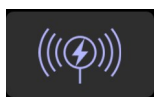

Connection status icon

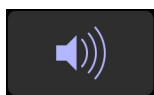

Audio menu

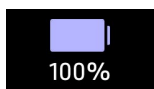

Power icon



Media menu

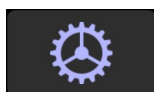

Settings menu

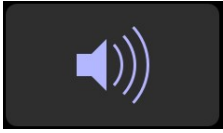

## Connection Status icon

The connection status icon displays the status of the connection between your NINJA V and the AtomRemote app.

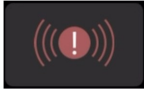

## Disconnected

Before connecting your device, you will see this icon.

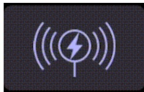

## Connected

After connecting your device, you will see this icon.

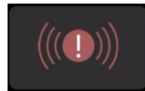
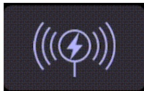

## Alternating loop between connected and disconnected icons

Device is connected in the background, but Remote mode isn't active. To enter remote mode, tap on the remote icon on the screen of your NINJA V.

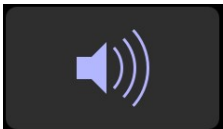

## Audio Menu

Tap the Speaker icon on the home page to open the Audio Menu.

## Audio Tab

The Audio tab provides options for monitoring each channel, changing your headphones volume and embedding your analog channel into the HDMI signal, or SDI signal where you have an SDI Expansion module attached.

These settings are identical to those on the Audio menu page on your NINJA V. Refer to the "Audio Menu" on page 213 section for more information.

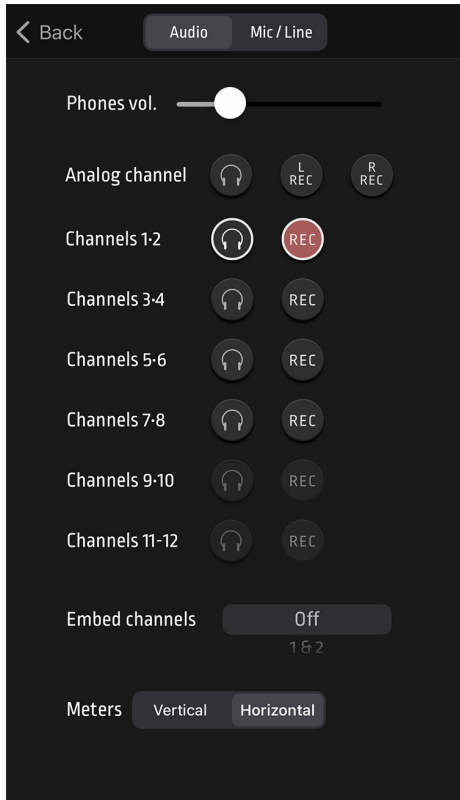

## Mic/Line Tab

This tab provides options for the left and right channels of connected analogue audio. These settings are identical to those on the Mic/Line menu page on your NINJA V. Refer to the "Mic/Line Menu" on page 216 section for more information.



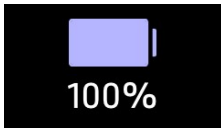
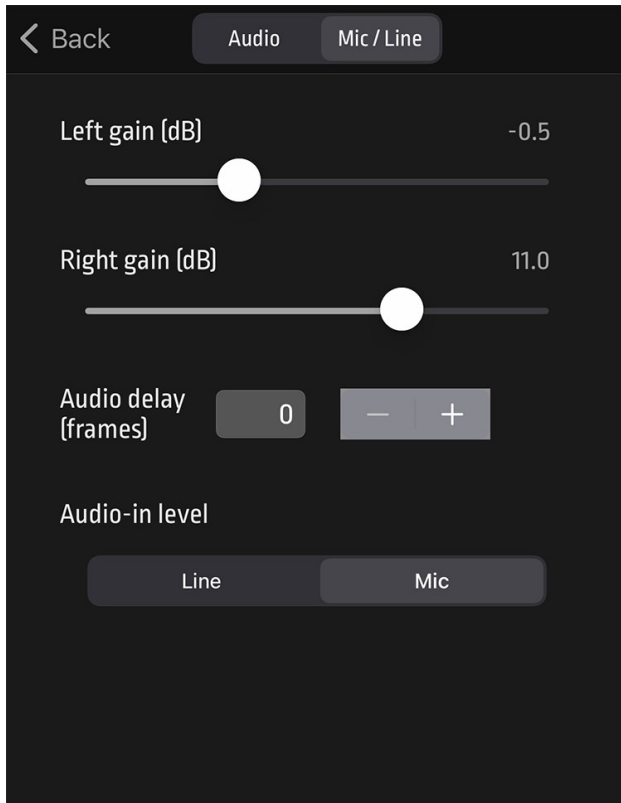

## Power Menu

The battery icon provides status information on the connected power source.

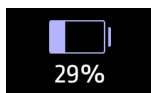

When a battery is connected, the remaining power level is displayed as a percentage.

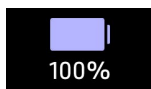

When connected to mains power via a Battery Eliminator, 100% will be displayed.

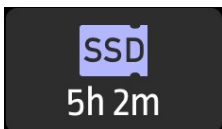

## Media Menu

Tap the SSD icon to open the Media Menu. Displayed under the icon, is the remaining recording time, which is based on the chosen codec and the remaining capacity of the drive. The settings on this page are identical to those on the Media menu page on your NINJA V. Refer to "Media Menu" on page 218 for more information on these settings.

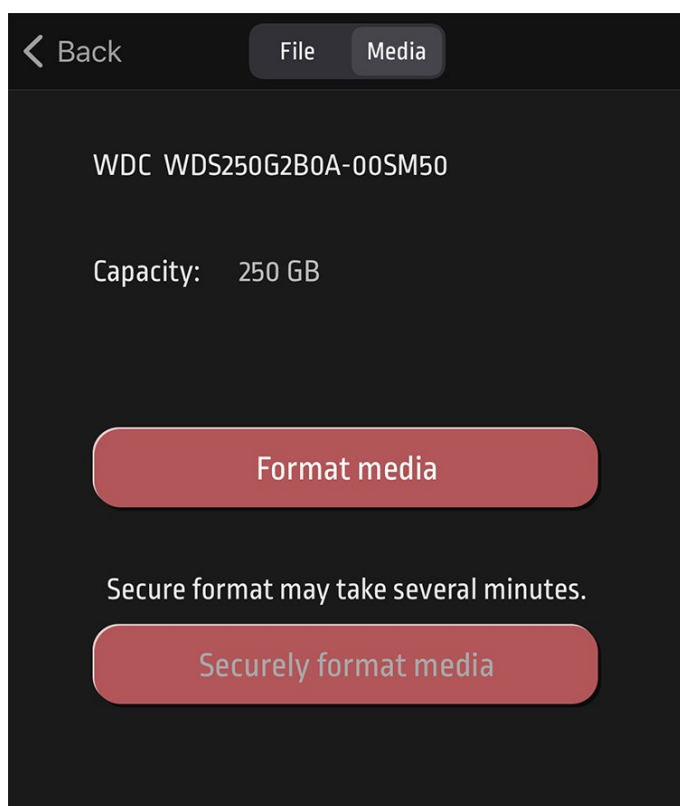

## Settings Menu

Tap the Cog icon to open the Settings Menu. Tap on the Time and Date, Timecode and Info tabs to adjust settings that relate to these elements.

### Time and Date Tab

It is vital you set the correct date and time on your NINJA V to ensure that the metadata for your files is correct. Enter the correct settings and tap on Set Time and Date. Alternatively, tap on Set to Current Time and Date to use the current time and date on your iOS device or Mac. For more information refer to the "Date Menu" on page 220 section.



*To set 12H or 24H time format, this setting needs to be adjusted in the Date menu on your NINJA V.*

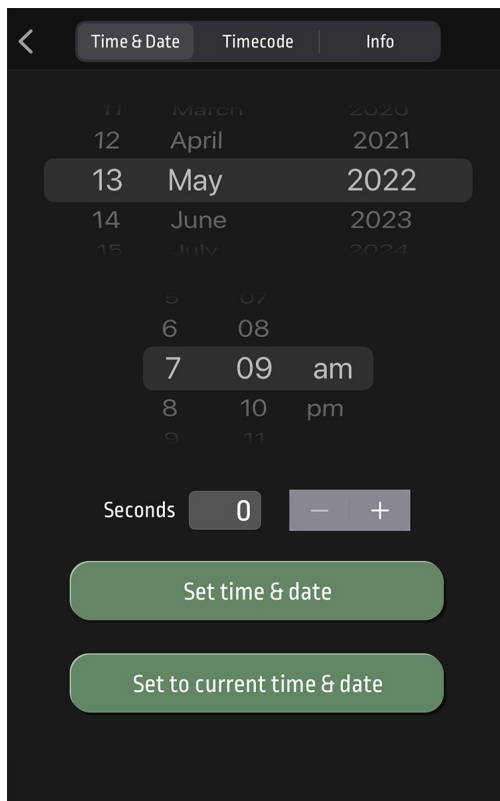

## Timecode Tab

The settings on this page are identical to those in the Timecode menu page on your NINJA V. Refer to the "Timecode Menu" on page 197 section for more information on these settings.



*To enable/disable HDMI Out Timecode, this setting needs to be adjusted in the Timecode menu on your NINJA V.*



*The AtomRemote app does not provide settings to adjust the AtomX SYNC module's wireless Timecode functionalities. These settings need to be adjusted on your NINJA V. For more information, refer to the AtomX SYNC Expansion Module section.*

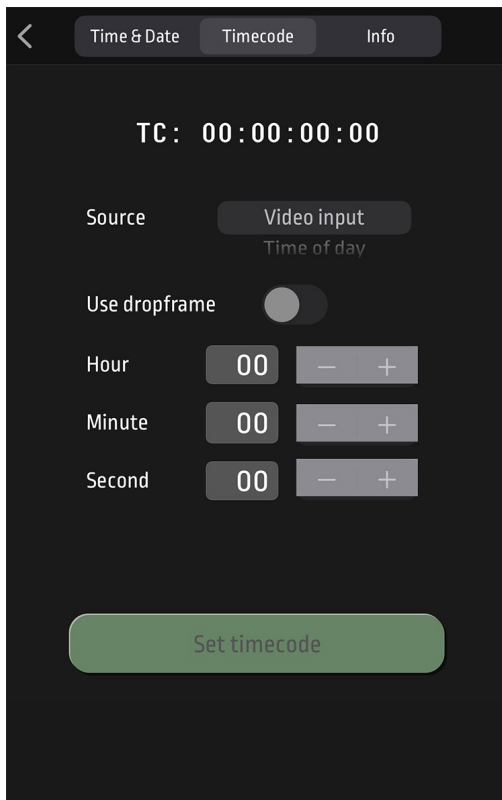

## Info Tab

This tab provides information on the version of the AtomRemote app that is installed and the software (firmware) version and unique device ID (DID) of your NINJA V device. The page also provides information on attached AtomX modules.

The information and settings on this page are identical to those in the Info menu and AtomX menu pages on your NINJA V. Refer to the "Info Menu" on page 233 and "AtomX Menu" on page 230 sections for more information on these settings.

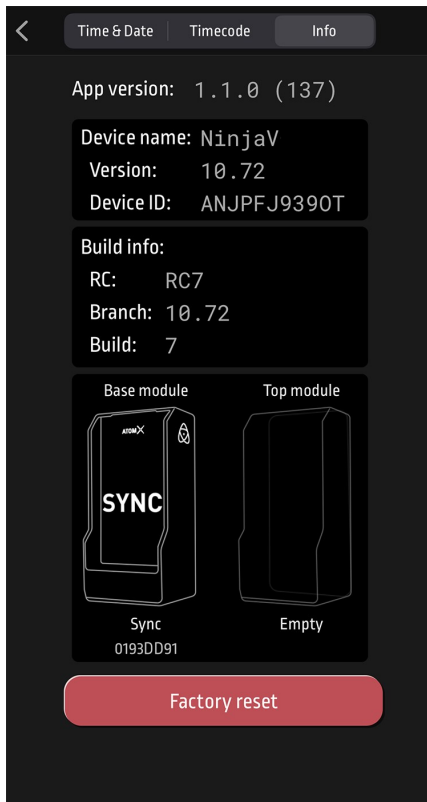

# AtomRemote - Input, Monitor and Output

These pages provide settings for the input, monitor and output. Once you have entered one of these menu pages, you can swipe left or right on the screen to move between the menu pages.

---

## INPUT MENU

This menu provides options for the input signal.



*Some of the Input menu settings cannot be adjusted by the AtomRemote app. These settings should be adjusted from the Input menu on your NINJA V. For more information refer to the Input Menu section.*

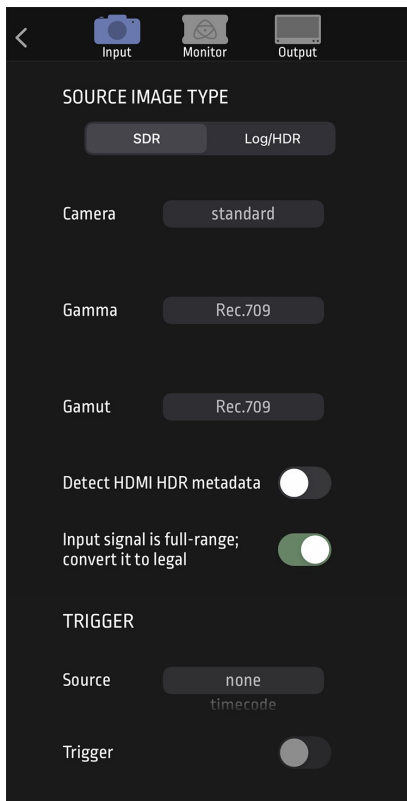

## SOURCE IMAGE TYPE

Allows you to select the source image type as SDR or Log/HDR and set the camera output settings.



*For the best image processing results it is essential to match the NINJA V settings to the camera/input settings.*

The information and settings on this page are identical to those in the Camera Output section in the Input menu on your NINJA V. Refer to the "Camera Output" on page 102 section for more information on these settings.

### **Detect HDMI HDR metadata**

Equivalent to the HDR Auto setting on the Input menu page. Refer to "Camera Output" on page 102 for more information on this setting.

### **The Input Signal is Full Range; Convert it to Legal**

Equivalent to the Legalize setting on the Input menu page. Refer to "Camera Output" on page 102 for more information on this setting.

## TRIGGER

These settings allow the NINJA V to be remotely triggered to record from your camera, and are identical to those in the Input menu on your NINJA V. Refer to the "Trigger" on page 95 section for more information on these settings.

-----

## MONITOR MENU

This menu provides settings for the monitor mode of your NINJA V, and provides settings for LUTs and monitor adjustments.

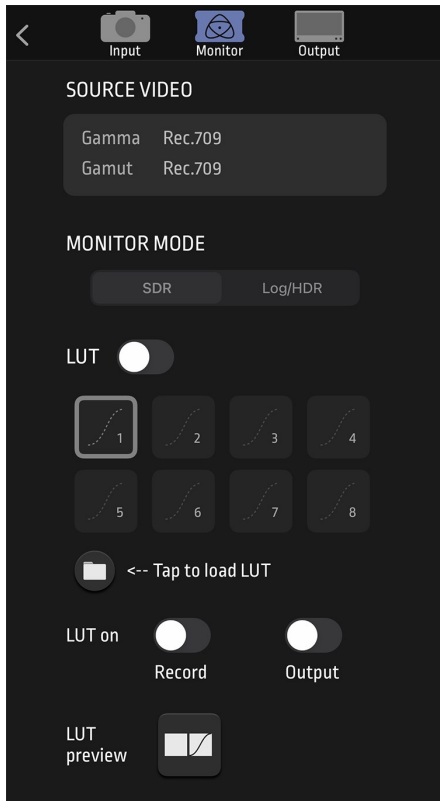

## SOURCE VIDEO

The source input Gamma and Gamut that were set in the input menu are displayed here.

## MONITOR MODE

Select SDR or Log/HDR mode, depending on how you want to monitor the signal on your NINJA V. When the input is set to Log/HDR, the input signal is displayed in its native form, which is usually a flat or washed out image. You can then choose to enable a LUT, which displays the input source with the selected user Custom 3D LUT.

## LUT

Allows you to apply the selected LUT to the image. Tap to toggle between enabled and disabled.



## Loading a LUT

Tap on one of the numbered slots to select it. Slots that already have a LUT loaded will have a curve next to the slot number whilst empty slots will not. Tap on the folder icon to access your media and select a LUT to upload. For more information on loading LUTs refer to the "LUTs tab" on page 321 section.

## LUT On Record

If this option is selected, your NINJA V will bake the LUT look into the recording. When enabled, a CUSTOM LOOK icon will flash in the top corner of the monitor and the LUT cannot be activated during recording to avoid any potential issues with the recorded content.



*Baking a LUT into your recording cannot be undone in post-production, so we advise that you consider your workflow before the use of this option.*



*Baking the LUT into your recording is not supported when recording with the ProRes RAW codec.*

## LUT On Output

OUTPUT LOOK – With this option, the selected LOOK is also applied to the HDMI loop out of the NINJA V. This will allow for instant preview on a larger monitor or to be used with a wireless sender. This function can also be combined with the down convert option that can be found in the input menu.

## LUT Preview

During color management it's likely that you may want to review a number of LOOKs and even compare them to the Native Video Source. Tapping the Compare option will apply a 50/50 vertical screen split that will show both the Natural Source Video and the selected LOOK of the LUT.

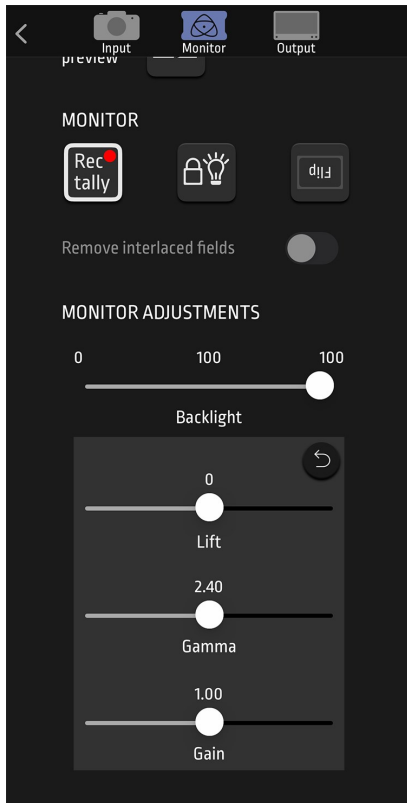

## MONITOR

These settings provide monitor options for your NINJA V, including Tally, Display Off and Flip mode. These icons are identical to those in the Monitor Mode menu on your NINJA V. Refer to the "Monitor tab" on page 327 section for information on these settings.

### Remove interlaced fields

Tap this setting to remove interlaced fields when working an interlaced signal.

### MONITOR ADJUSTMENTS

These settings on this page are identical to those in the Display menu on your NINJA V. Refer to the "Display tab" on page 331 section for information on these settings.

-----

## OUTPUT MENU

This menu provides settings for the signal that is being output from your NINJA V over HDMI and SDI to external displays.

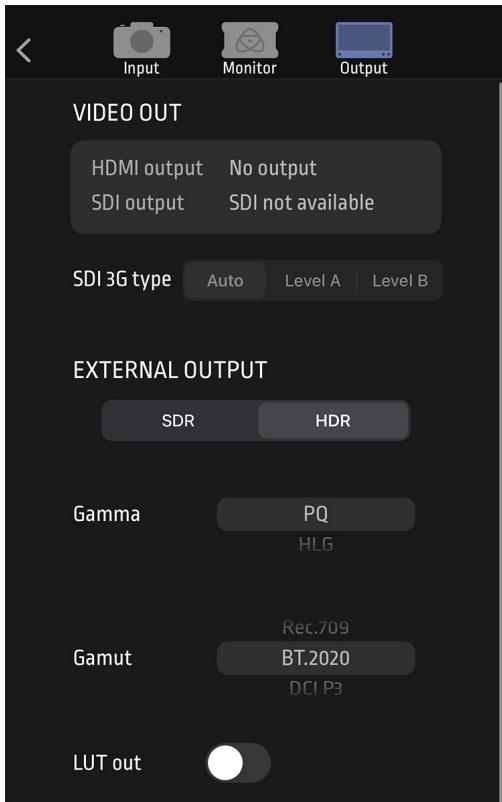

## VIDEO OUT

Displays the active video format being output from HDMI or SDI to an external monitor, as well as the status of any processing options applied. When working in HDR, a signal will be output with the correct HDR flag to activate a compatible HDR display's settings. This can be useful if you wish to monitor log footage in the studio.

### SDI 3G Type

Set the 3G Output type for compatibility with connected equipment that expects a specific type of 3G-SDI video. Tap to select Level A, Level B or Auto.

# EXTERNAL OUTPUT

## SDR/HDR

Tap SDR or HDR to select the signal output type. Selecting HDR will set a LOG to HDR transform.

 *For Log outputs, select HLG and 709 for a normalized SDR image*

## Gamma

Select from PQ, HLG or Dolby for HDR. Select Rec.709 for SDR mode. Tap to scroll through the options.

## Gamut

Select from Rec.709, BT.2020 or DCI P3 in HDR mode. Set at Rec.709 for SDR mode. Tap to scroll through the options. Refer to the "Output Menu" on page 107 section for more information on these settings.

## LUT Out

Allows you to loop out LUTs that are applied to your image, so that they are also applied to the Output signal. Tap to enable/disable.

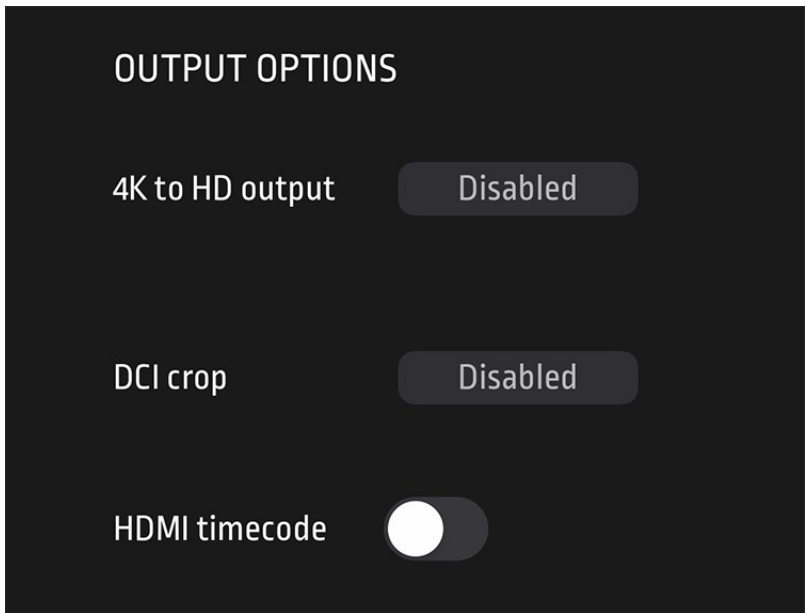

**OUTPUT OPTIONS**

- 4K to HD output  Disabled
- DCI crop  Disabled
- HDMI timecode

## **OUTPUT OPTIONS**

These settings are identical to those in the Output menu on your NINJA V. Refer to the "Output Menu" on page 107 section for more information on these settings.

# AtomRemote - Record menu

This menu allows you to adjust your recording settings, including codec, compression, pulldown. The settings on this page are identical to those on the Record menu page on your NINJA V. Refer to "Record Menu" on page 112 for more information on these settings.

## Time Remaining

Displays the remaining recording time based on the chosen codec and the remaining capacity of the drive.

## Record Format

Displays the current recording resolution and frame rate.

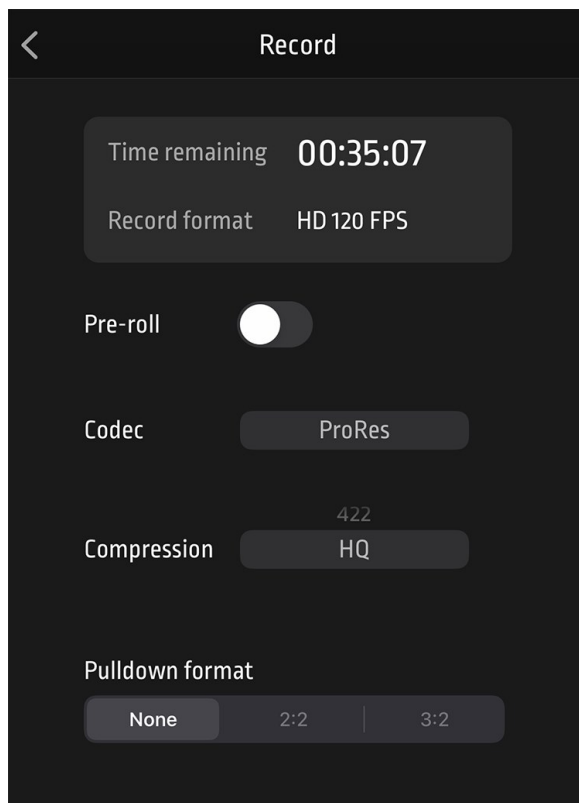

## **Pre-Roll**

Tap to enable/disable the pre-roll function. For more information on pre-roll, refer to the "Record Menu" on page 112 section.

## **Codec**

Tap to scroll through the options to select a codec. For more information on codecs, refer to the "Record Menu" on page 112 section.

## **Compression**

Tap to scroll through the options to select the compression level for the currently selected codec. For more information on compression, refer to the "Record Menu" on page 112 section.

## **Pulldown Format**

Tap to select a pulldown format. For more information on pulldown, refer to the "Pull-down" on page 119 section.

# AtomRemote - Monitor Assist Settings

Tapping on the Monitor-assist settings button opens the Monitor Assist Settings page, which provides options and settings for each of the monitoring assist tools.

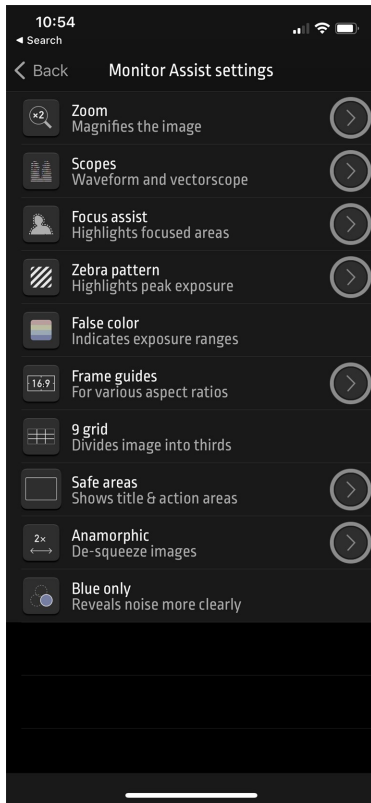

Tap on the arrow to the right of each tool to access its settings. The following screen will appear when you tap on the arrow next to Zoom:



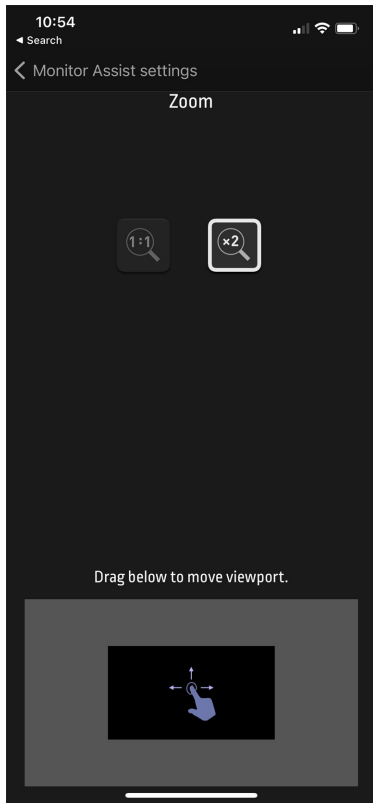

For more information on the options and settings for each of the monitoring assist tools, refer to the Monitoring Features section.

## Using the AtomX CAST

The AtomX CAST is a modular expansion for the NINJA V, that connects to the AtomX expansion port to convert the NINJA V into a fully functional stand-alone video switcher with 4 x 1080i/p HDMI inputs, a multiview monitor and broadcast quality recorder, with graphic overlays, picture in picture functionality and a streaming output.

Any interlaced or progressive video source up to 1080i/p60 can be connected to the HDMI inputs on AtomX CAST. These sources will automatically be conformed in the background to be progressive and also to match the project frame rate.

When using AtomX CAST, the Information Bar at the top of the NINJA V screen displays information and settings for your project rate, outputs, audio settings and more. Touching any of these areas will take you to the relevant menu. For more information on these settings, refer to the "CAST - Main Screen" on page 269 section.

To purchase an AtomX CAST visit [atomos.com/accessories/atomxcast](https://atomos.com/accessories/atomxcast)



*To use AtomX CAST with your NINJA V, firmware version 10.71 or later needs to be installed.*

# Attaching AtomX CAST to your NINJA V

## How to attach AtomX CAST to NINJA V:

1. Place AtomX CAST on a flat surface with buttons facing upwards, and undo the 1/4-20 screw in the center of the unit to release the top bracket. Line up the AtomX expansion port of the NINJA V with the expansion module on the AtomX CAST.
2. Gently slide the AtomX CAST into the AtomX expansion port until it clicks into place.
3. Tighten the 1/4-20 screw on the top bracket to the top mounting point on NINJA V to secure it in place.
4. To remove the AtomX CAST from your NINJA V, undo the 1/4-20 screw on the top bracket and press the NINJA V's battery release button. Gently slide the AtomX CAST away from the NINJA V.

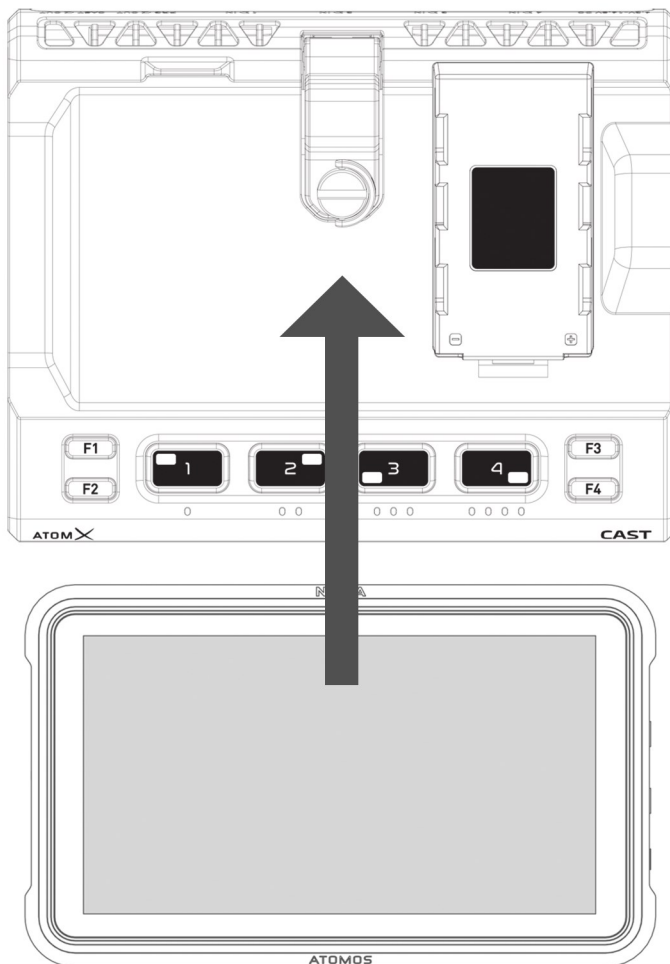

# Powering the AtomX CAST

When you have an AtomX CAST connected to your NINJA V, the 12V-3A AC power supply that was included with your NINJA V supplies power for both NINJA V and AtomX CAST. Connect the DC connector to the DC input on the AtomX CAST to provide power to both devices. For more information on the AtomX CAST connections, refer to "AtomX Expansion Modules" on page 52

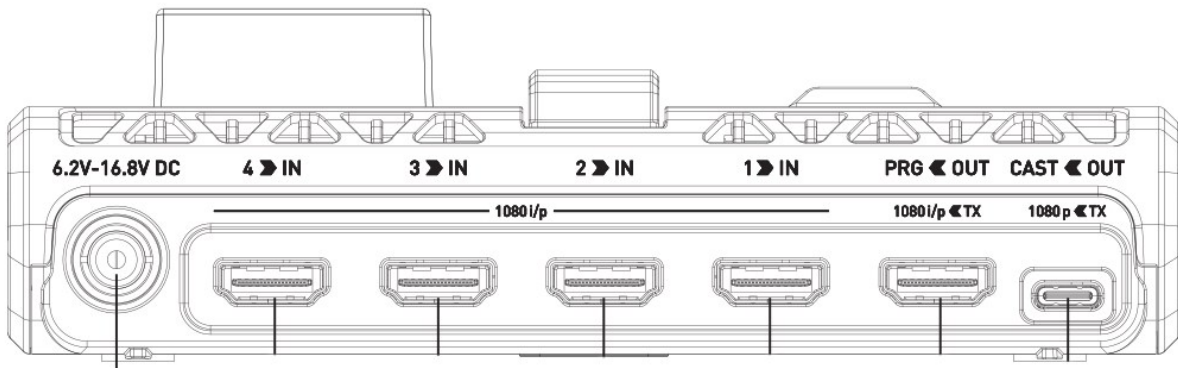

## A. DC Input

# Connecting the AtomX CAST to your Computer

The AtomX CAST connects to your computer via USB-C and appears instantly to the computer as a webcam.



*AtomX CAST must first be connected to your NINJA V before connecting to a computer. For more information refer to the "Attaching AtomX CAST to your NINJA V" on page 266 section.*

## How to connect AtomX CAST to your computer:

1. Connect one end of the supplied USB-C cable to the USB-C port labelled CAST USB-C on AtomX CAST and the other end to a USB-C port on your computer. If your computer only has USB Type-A connectors, a USB-C to USB-A adapter will be required.
2. Once connected to your computer, you will be able to select the AtomX CAST as a camera and audio source within video applications like Zoom, Teams and Skype without the need to install drivers on the computer first.
3. For setup guides on setting up your AtomX CAST to work with specific applications on Mac and Windows, refer to the [Streaming and Switching](#) section on our support page.

# CAST - Main Screen

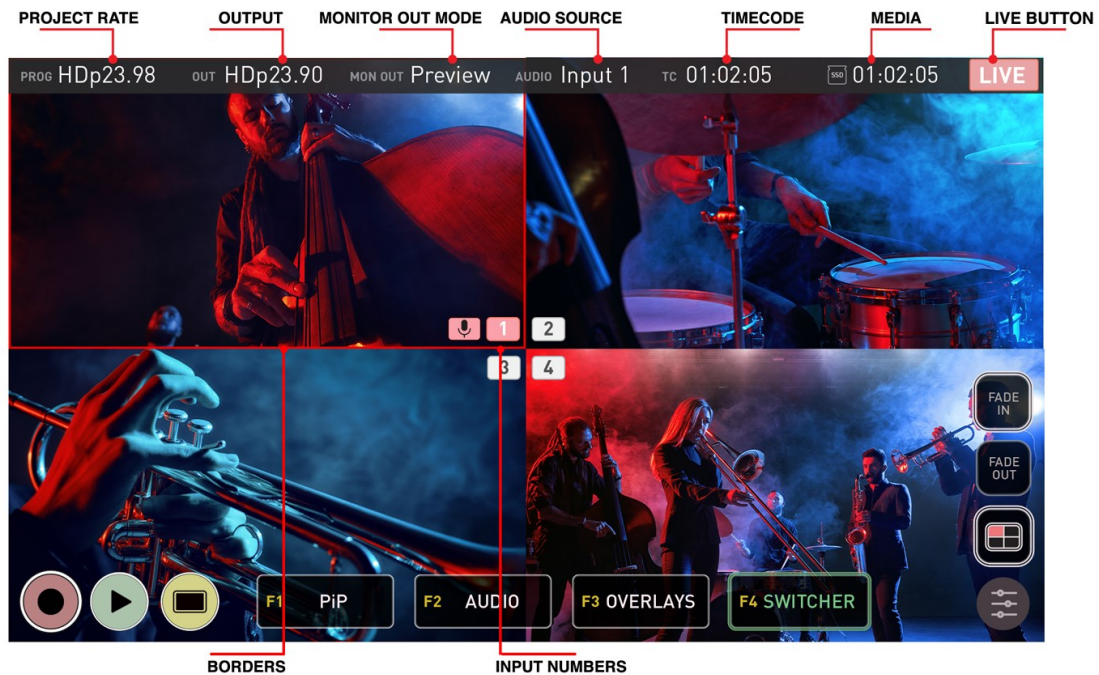

**PROJ:** Displays the Project Rate, which is determined by the resolution and frame rate of the Primary Input.

**OUT:** Displays the active video resolution and frame rate being output from the CAST Out and the CAST USB-C connectors on AtomX CAST.

**MON OUT:** The output mode of the NINJA V HDMI Out connector. This can be selected in the Output and Switcher menu pages, and can be set to:

- Program,
- Preview or
- Multiview

**AUDIO:** Displays the audio source that you selected in the Audio menu page. When HDMI Input is selected, the chosen input will be displayed, eg. Input 1 where Mic/Line has been selected, MIC/LIN will be displayed and AFV will be displayed where Audio Follows Video has been selected.

**TC:** Displays Timecode.

**MEDIA:** Displays the remaining recording time on your media, based on the chosen codec and remaining capacity of the drive.

**LIVE:** The Live button allows you to enable or disable the live stream output. It is important to note that the LIVE button must be pressed to allow your program feed to be output to your streaming software and/or connected Program display via the CAST USB-C and CAST HDMI outputs. A connected display in Program mode can be used to confirm that you are outputting a stream to your audience, as well as what they are seeing. This output will not have an image until you are live. Tapping the button will cycle between red for enabled, and greyed out when disabled.



*If a Primary Input has not been selected, the Live button cannot be enabled.*

**BORDERS:** The borders around the inputs indicate the status of each input. When selected as the program output, the border around that input will be red. A green border indicates that the input is being previewed in Two Touch switching mode.

**INPUT NUMBERS:** The input numbers in the center of the screen indicate the status of each input. They will be white when there is a valid input, and greyed out when there is no input. When selected as the program output, the input number will be red. The input number will be green when the input is being previewed in Two Touch switching mode.

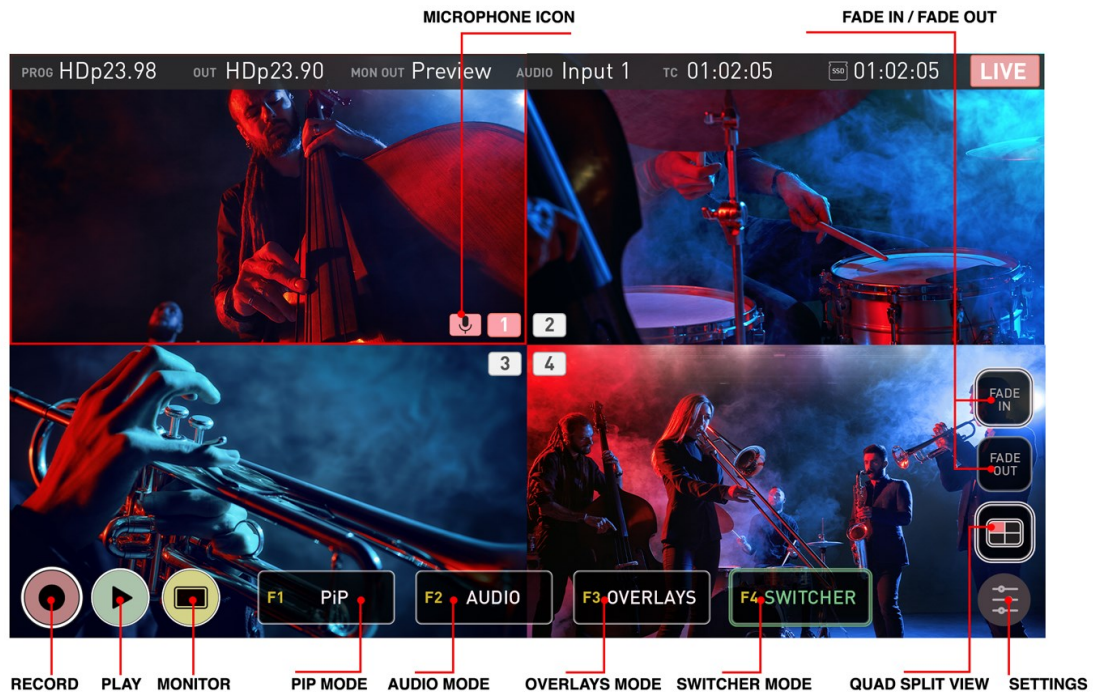

**MICROPHONE ICON:** Where the audio source is set to HDMI Input, a red microphone icon will appear next to the input number in the center of the screen to indicate that the input is the current audio source. If there is no audio coming from the input, a grey

microphone will be displayed instead. In Audio Follows Video (AFV) mode, a blue microphone icon will be displayed next to the input that is the current audio source.



*Where Mic/Line has been selected as the Audio Source, MIC/LIN will appear at Audio at the top of the screen to indicate the mode. No microphone icon is displayed over any of the inputs.*

**FADE IN / FADE OUT:** These buttons can be used to fade in or fade out of your program. You can set the color to fade to/from as White or Black in the Switcher menu. Having dedicated Fade In/Out buttons gives you complete control so that you can fade out from one input, switch to another input and fade back in. Fading In/Out also applies an Audio fade effect.

**QUAD SPLIT VIEW BUTTON:** Tap to toggle between the multiview mode where you can see all four inputs at once for switching, and the single input view which displays one input at a time. The single input view is perfect for checking and adjusting each input full-screen, with the aid of the monitoring tools. Tap the button again to return to the quad split view for switching.

**SETTINGS:** Pressing the settings button will take you to the corresponding menu page for the current mode: PiP, Audio, Overlays and Switcher.

**RECORD:** Press to begin recording the program stream.



*The LIVE button must be pressed to allow your program feed to be output to your streaming software and/or connected Program display via the CAST USB-C and CAST HDMI outputs. The LIVE button must be enabled for either of these outputs to be active.*

**PLAY:** Press to enter playback mode and play back the most recently recorded clip. Tap RECORD to return to the switching/recording mode.



*When you are live, the Playback button will be greyed out and disabled. This ensures that the stream cannot accidentally be played back during a live session.*

**MONITOR:** Tapping Monitor in single input view mode reveals the monitoring tools, so that you can switch between the camera inputs and use the tools to check your shots. You can use scopes like the Waveform to check exposure, Focus Peaking to check focus and Frame Guides to help you frame your content for a specific aspect ratio or for social media. For more information, refer to the Monitoring & Recording section.



## CAST - Function Icons F1- F4

These icons have the same effect as the physical F1-F4 function buttons on AtomX CAST. Tapping the F1-F4 icons or pressing the physical F1-F4 buttons will allow you to use the four physical 1,2,3,4 pad buttons on the unit to switch between options in the selected mode. The following refers to the icons on screen, as well as the physical buttons on the unit.

### F1 PiP (Picture in Picture)

In this mode, the 1-4 buttons act as a PiP switcher. Once F1 has been selected, you can use the pad buttons to select an input to use as a PiP over the Program Out. The currently selected input button on AtomX CAST will be red to indicate it is live. Pressing one of the other input buttons will turn them yellow, and select that source to be displayed as a picture in picture over the current program output. Press one of the other pad buttons to use that input as a picture in picture instead. Pressing the input button whilst it is yellow or pressing the red input button, will turn off the PiP effect on the program out.

When in F1 PiP mode, pressing the settings button will open the PiP menu page. For more settings in relation to the PiP function, refer to the "CAST - Picture in Picture (PiP) menu" on page 282 section.



*You can change the size, position and opacity of the PiP whilst it is live, by using the PiP menu page.*

### F2 AUDIO

In this mode, the 1-4 pad buttons act as an audio switcher. Once F2 has been selected, you can then use the input selection pads 1-4 to switch between the audio from the 4 x HDMI inputs connected to AtomX CAST. The selected input button will turn red when pressed. Pressing the pad button whilst it is red, will switch to AFV (Audio Follows Video) mode, and the button will turn blue. Pressing on the selected input button when blue will switch to the audio from the selected input again.

When in F2 Audio mode, pressing the settings button will open the Audio menu page. For more settings in relation to Audio sources, refer to the "CAST - Audio menu" on page 287

### F3 OVERLAYS

In this mode, the 1-4 pad buttons act as a graphics switcher. Once F3 has been selected, pressing one of the input selection pads 1-4 will turn the selected pad button green and apply the overlay to the Preview output of the Ninja HDMI output. This allows you to

preview each of the graphical presets over the current input. When you decide on the preset to use, press and hold the green input button to turn the button red and lock that graphical preset to the input.

The preset will appear on the Program feed and be locked to this input so that whenever you switch to that input in switcher mode, the graphics in the selected preset will appear. This is especially useful where you have multiple speakers, as they can all have a lower thirds graphic with their name and details appear whenever you cut to them. You can deactivate an overlay in both program and preview modes, by holding the button until the red light changes to white.

When in F3 Overlays mode, pressing the settings button will open the Overlays menu page. To create or adjust the graphical overlay presets and for more settings, refer to the "CAST - Overlays menu" on page 279 section.

Tapping on another input via the 1-4 pad buttons or on the multiview screen in this mode, will place a green preview border around the chosen input on screen, and the corresponding input selection button on the AtomX CAST will also be green. The selected input will also be displayed on a connected display in Preview mode. If you select another input instead, the selected input will be previewed instead. This allows you to literally preview your inputs before you cut to them in the program feed.

A second tap on the same input on the display or on the input selection button whilst they are green, will turn it red and cut to that input immediately. If you do not want to switch to the input being previewed, tap on the currently selected input again on the NINJA V display or press the input selection button that is red. Selecting the F4 key whilst green will return to One Touch switching mode.

When in F4 Switcher mode, pressing the settings button will open the Switcher menu page. For more information on switching settings, refer to the "CAST - Switcher Menu" on page 284 section.



*If the F2 function is used as described above when Mic/Line is selected in the audio menu page, the Audio Source will switch to HDMI Input mode.*



*If you have selected analog audio input, none of the pads will be illuminated red.*

## **F4 SWITCHER**

In this mode, the 1-4 pad buttons preview and switch between the inputs. When F4 is initially selected, it will turn red and One Touch switching mode will be enabled. Tapping/pressing the F4 key again whilst it is red, will cause the F4 button to become green

and the Two Touch switching mode will be enabled. In this mode, you can preview inputs before actually switching to them.



## Primary Input

A green circle with a 'P' will be visible below the source that is the current Primary Input. The Primary Input will determine the project rate and provide sync for other inputs. By default, the first connected source will be used as the Primary Input. To select another source, tap on the white circle in the Primary Input row, below another input. Other inputs with a different frame rate up to 1080i/p60 will be conformed in the background to match the project rate.



*Ensure that you have selected the project rate before going live, as this cannot be changed when live. If you do change the project rate whilst being LIVE you may lose your USB-C connection, and have to unplug it and reboot the device.*

## Video Mode

Displays the resolution and frame rate for each input. No Input will be displayed where a valid input is not detected.

## Project Rate

The frame rate of the Primary Input will be used as the Project Rate by default, and all other inputs up to 1080i/p60 will be conformed to this frame rate.

## Graphics

Indicates the graphical overlay presets that are applied to each input.

## Audio Pairs

Indicates how many audio pairs are associated with each input. No Input will be displayed where a valid input is not detected.

# CAST - Output menu

The Output menu allows you customize your setup, by choosing what to display on the outputs.

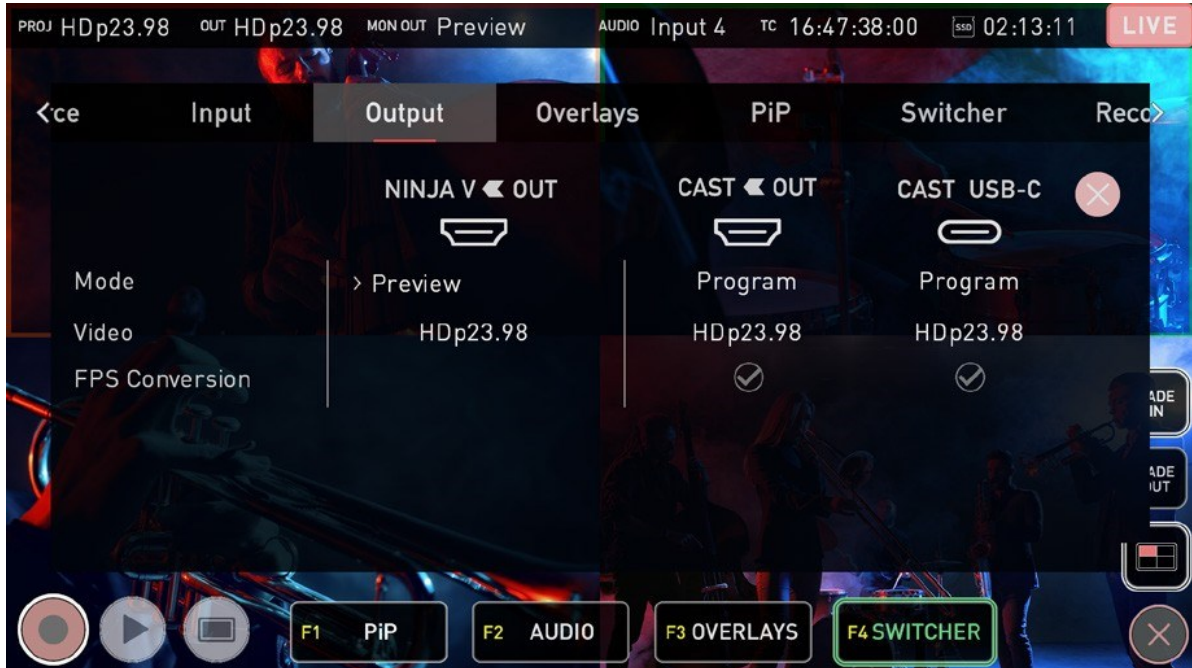

## Mode

Displays the mode that each of the outputs is currently set to. The icons will be faded with an 'x' when not connected.

### NINJA V OUT

Allows you to select the mode for the NINJA V's HDMI Out connector, for displaying on a secondary output. The frame rate will be the same as the project rate. Tap on the currently selected mode to cycle through the following options:

- **Program:** Displays the 'program' that you are streaming to your audience. This mode shows you exactly what they will see.
- **Preview:** Allows you to preview inputs before you cut to them in the program feed, as well as preview graphics.
- **Multiview:** This mode allows you to see all four inputs at once, without Graphic overlays, PiP, Program/Preview and audio channel status

## **CAST OUT / CAST USB-C**

Displays the current mode for the HDMI Program Out and USB-C connectors on AtomX CAST. These outputs are linked and will always display the program feed.

## **FPS Conversion**

Displays conversions of resolution and frame rate. A green circle with a tick will indicate successful FPS conversion to the project rate. A circle with an 'X' will be displayed in the CAST OUT and CAST USB-C columns when FPS conversion is not activated.

CAST USB-C streaming output is limited to a maximum of 1920x1080p30. For projects that have a frame rate of 50p or 60p, FPS conversion will be applied, and both the HDMI and USB-C outputs from the AtomX CAST will output at a half frame rate i.e p50 as p25 and p60 as p30.

HDMI projects can be output as 1920x1080p50 or p60 without FPS conversion but the CAST USB-C streaming output will not be available.



*FPS conversion can only be activated when you are not live.*

## CAST - Overlays menu

The settings in this menu allow you to upload up to 8 custom graphics to the NINJA V's internal memory, and then assign them to the anchor positions within the four layout pre-sets. The presets can then be set to appear on certain inputs whilst switching.

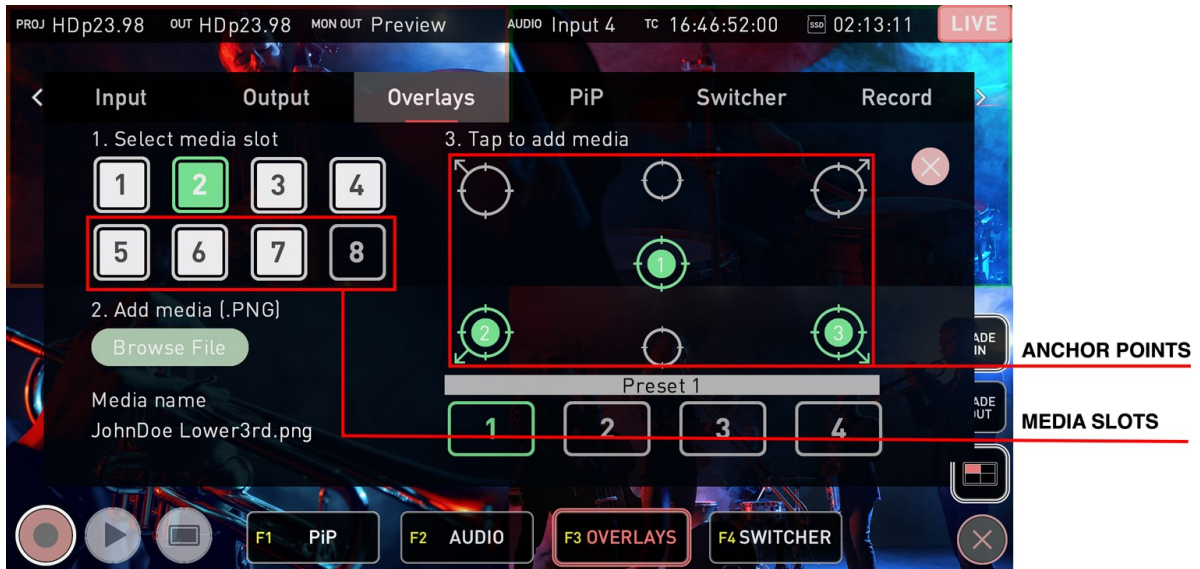

Image creation programs like Adobe Photoshop can be used to create your own custom graphics for a logo, masthead, lower thirds graphic or even a large image that covers the entire screen.

Graphical overlays do not appear on the multiview screen of the NINJA V, but can be previewed on a connected display in Preview mode before being used in the Program. You can also set and lock a graphical preset to an input so that it appears each time that you switch to that input. For more information refer to the "CAST - Function Icons F1- F4" on page 272 section.



*Graphics must be in PNG format, but can be any resolution up to 1920 x 1080. Graphics that contain alpha channels/ transparency are also supported.*



*If using an image creation program like Adobe Photoshop to create graphics, ensure that you save them in .PNG format.*



*Graphics can be up to 1MB in file size.*



## Presets 1-4

Select one of the four presets along the bottom marked 1-4 to select a preset to create/edit. When this preset is selected during switching, the graphics will appear on screen in the position(s) you have selected.

## Media Slots 1-8

Each of these numbered media slots can store a .PNG graphic in the NINJA V's internal memory. Tap on one of the numbered media slots to select one of the slots. If all slots are full and you want to add a new graphic, select one of the slots and tap Browse File. You will be prompted to overwrite the graphic that is currently saved in this slot.

## Browse File

Tap on Browse File to browse the media inserted in your NINJA V for PNG media. Tap on a .PNG file to select it and tap on it again to load it into the selected media slot. The file-name of the selected media will be displayed below Browse File.



*You can use a graphic in multiple presets, but you can only have one instance of each graphic in each of the presets.*

## Anchor Points

Each of these circular positions is an anchor point, which anchors the graphic to the chosen position. If you select the top left anchor point, the top left corner of the graphic will be anchored to the top left corner of the frame. If you select the bottom left anchor point, the bottom left corner of the graphic will be anchored to the bottom left corner of the frame. For the three center anchor points, the centre of the image will be anchored to the chosen anchor point.

After selecting one of the media slots, tap on an anchor point to add the graphic to the chosen anchor point location on screen. A green circle with the media slot number will appear in this position. To relocate the graphic, tap the location anchor and the green icon will disappear, removing the graphic from the location. Tap on another anchor point to relocate the graphic to that anchor point instead.



*In order to clear graphics from assigned positions, tap on each graphic in each preset to disable them individually.*



*If your graphic is not in the correct file format or within the 1MB size limit, an error message will advise that the image is not in the correct format.*

## CAST - Picture in Picture (PiP) menu

This menu allows you to display an input as a scaled input overlay in the corner of the screen over the top of any program output, so that they both appear on screen at the same time. You can use this feature to present to the camera, whilst showing the viewer another angle, a presentation or pre-recorded content at the same time. In order to see the PiP appear over another input, a connected display in Program mode is required.

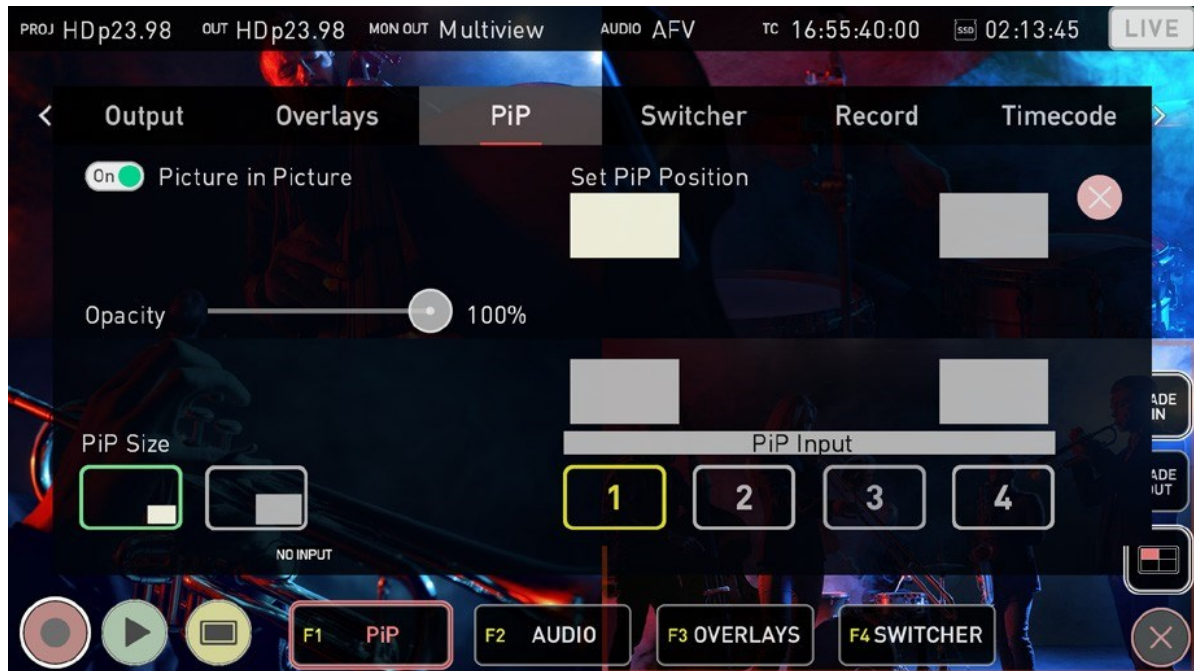

### Picture in Picture On/Off

Enable/Disable the Picture in Picture function by tapping the On/Off switch.

### Opacity

Use the slider to adjust the opacity of the PiP input.

### PiP Size

Select the size of the PiP effect by tapping on the small or large preset.

### Set PiP Position

Adjust the position on screen for the picture in picture effect to be displayed.

## PiP Input

Select the input that will appear as a PiP over the input that is live.



*The system automatically disables PiP when it is not required, such as situations where you would have a PiP image displayed over the same image.*

# CAST - Switcher Menu

This menu allows you to customize your settings for switching.



## Switch With

Allows you to select the style of switching to use whilst in the Switcher mode. Tapping Switch With or the F4 button, cycles between the options:

- **One Touch**

In this mode, a single touch on one of the inputs on the Ninja display when in multiview mode, or on one of the physical 1-4 buttons on the AtomX CAST, will switch to the corresponding input immediately. The input on screen will have a red border around it and the corresponding button on the CAST will turn red when selected, to indicate that it is live. The F4 button will also be red in One Touch mode.

- **Two Touch**

Two touch recording, follows the traditional broadcast preview and program switching style, which allows you to preview an input before actually switching to it.

Whilst in this mode, the program feed on the NINJA V display will have a red border and the corresponding input selection button on the AtomX CAST will also be red. Tapping on another input will place a green preview border around the chosen input on the display, and the corresponding input selection button on the AtomX CAST will also be green. This indicates that the input is being previewed as the next source to cut to. The selected input will also be displayed on a connected display that is in preview mode. A second tap on the same input on the display or on the input selection button whilst they are green, will cut to that input immediately.

If you select another input instead, that will cause that input to be previewed instead. If you do not wish to switch to the input being previewed, tap on the program feed again on the NINJA V display or press the input selection button that is red.

## **Ninja HDMI Output**

This setting allows you to select the mode for the HDMI Output connector on your NINJA V. This will determine what is displayed on a monitor connected to this output. Tap the setting to cycle through the options:

- Program
- Preview
- Multiview.

## **Fade To Color**

Sets the color that your image will fade from/to when using the Fade In / Fade Out buttons. The color selected here is also used for dip to color transitions. Tap the setting to cycle through the color options:

- White
- Black

## **Transitions**

Tap to cycle through transition options:

- **None**

Sets no transition.

- **Dip to Color**

Sets Dip to Color as the transition type that is applied when you switch from one input to another.

## **Transition Duration**

Use the slider to set the duration of Dip to Color transitions between 100ms and 2 seconds.

## **Program Record**

Allows you to select what is recorded onto the media inserted in the NINJA V. Tap to cycle through the options:

- **Clean:**

Records a clean feed of the program output.

- **CAST Program mode:**

In this mode, graphical overlays, the picture in picture (PiP), Dip To transitions and Fades In/Out of the program stream are all recorded onto the media inserted in the NINJA V.

# CAST - Audio menu

This menu allows you to select the audio sources that will be used for the program output.

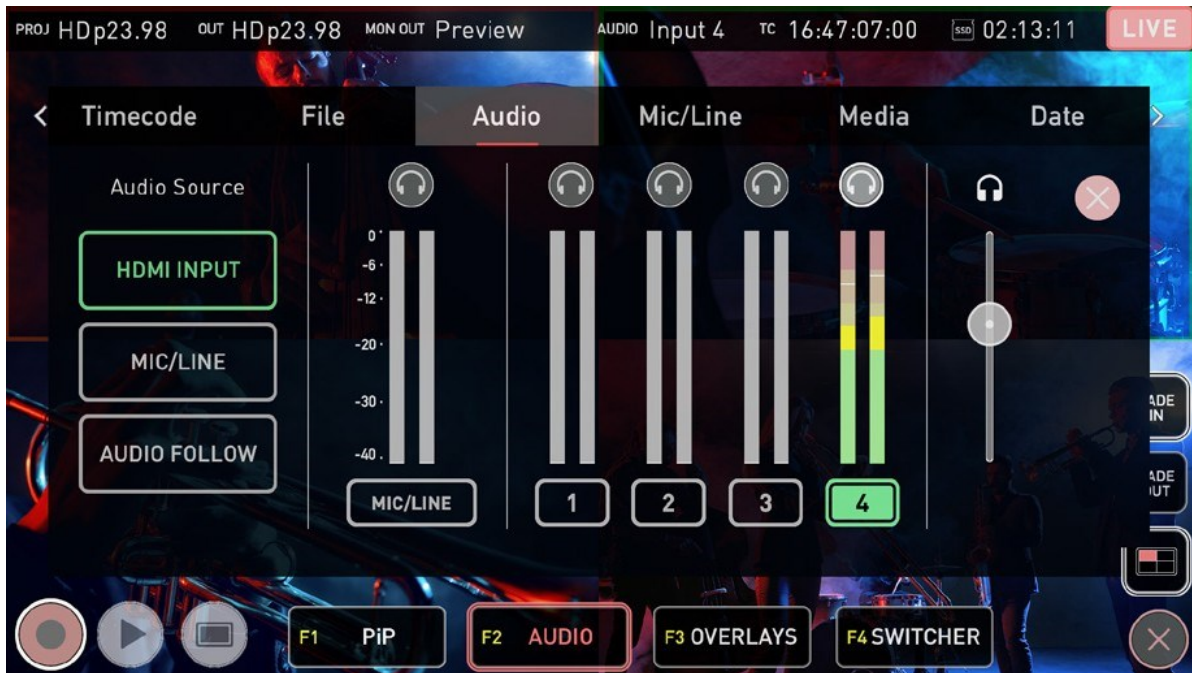

## Audio Source

Tap the buttons to select the audio source:

### HDMI Input:

Allows you to select the audio from one of the inputs connected via HDMI as your audio source. If you have four cameras connected to AtomX CAST, it would allow to use the audio from one of the cameras, which could be scratch audio from the camera's internal microphones, or audio from a microphone connected to the camera. For other types of inputs like pre-recorded videos, the audio could be coming directly from the source. After selecting HDMI Input, tap on the input number to switch to the audio from that input. A red microphone appears in the corner of the input displayed on the NINJA V when in multiview mode, to indicate the source of the audio.

### Mic/Line

This option allows you to connect an external audio source to the analog 3.5 mm Mic/Line jack on your NINJA V. In Mic mode, a dedicated high quality microphone can be connected directly or via an audio mixer which can dramatically improve your audio quality.



You could also use this input in Line mode, to add music to your production from an external source. The Mic/Line menu page allows you to adjust the settings for Mic/Line inputs.

### **Audio Follow (Audio Follows Video):**

When Audio Follow is selected in the Audio menu page, the audio will follow the video switching, so the audio from the currently selected input will be used. The corresponding physical pad button will also turn blue in this mode. Previous selected audio turns red.

## **Headphone icons**

The program audio can be monitored by connecting headphones to the 3.5 mm headphone/audio out jack on your NINJA V. Whilst in CAST mode, only the program out can be monitored. If you switch between audio sources or AFV, the headphone monitoring will automatically switch to allow constant monitoring of the program audio. Levels for other inputs can only be monitored on the meters visually.

## **Audio Meters**

Displays audio levels from the embedded audio of the four HDMI inputs/cameras.

## **Headphone Volume Slider**

This slider allows you to adjust the monitoring volume of the selected audio input.



*The headphone slider volume has no impact on the actual audio levels for each connected source, so if it is too loud you will need to adjust the audio levels on the connected camera or source.*



*You can select either the audio pair coming from the analog in (Mic/Line connection), OR the audio pair from the selected camera. There is no support multi channel audio.*



*To ensure that analog audio is synced correctly with the audio from your HDMI sources, connect analog audio sources to one of the HDMI cameras/*



*sources and select the audio from this input as your audio source. This will ensure that the audio will always be in sync with the video.*

## Setting up for recording

As soon as you connect a supported signal to the NINJA V input and have inserted a formatted drive the following will happen:

- The REC icon will be illuminated (red)
- The input source & format will be shown in the top left corner of the information bar (in monitor mode)
- Audio input meters will be responding to the source.

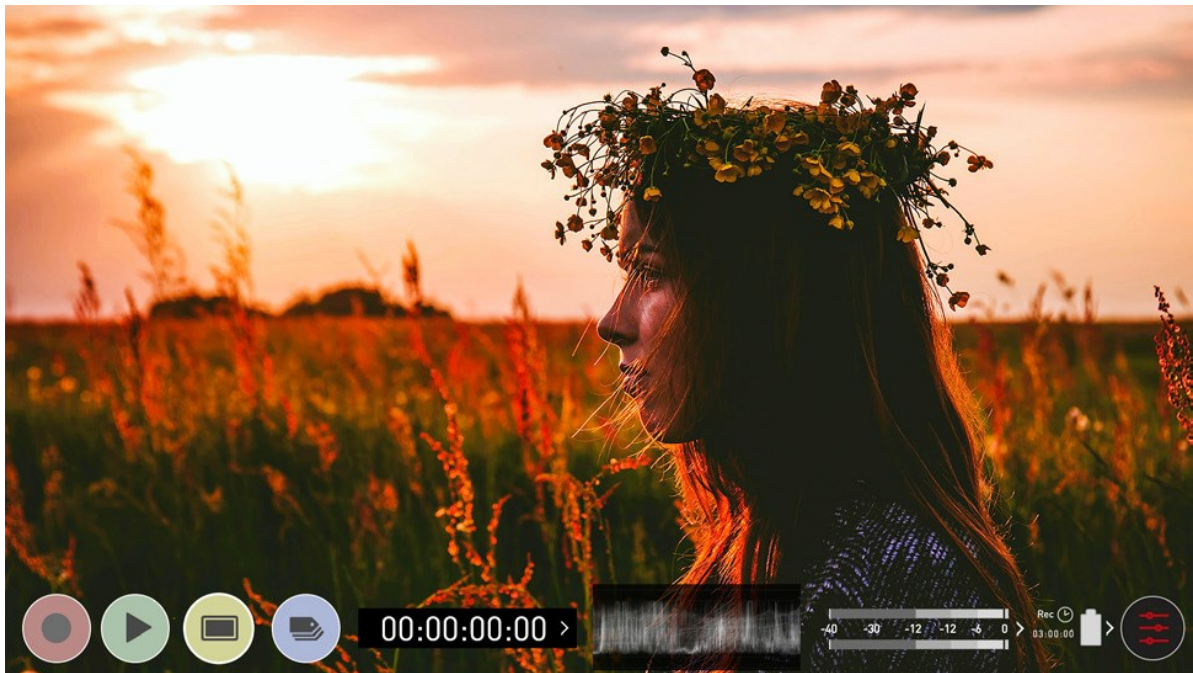

Ready to Record (monitor mode/home)



Ready to Record (monitor mode/features)

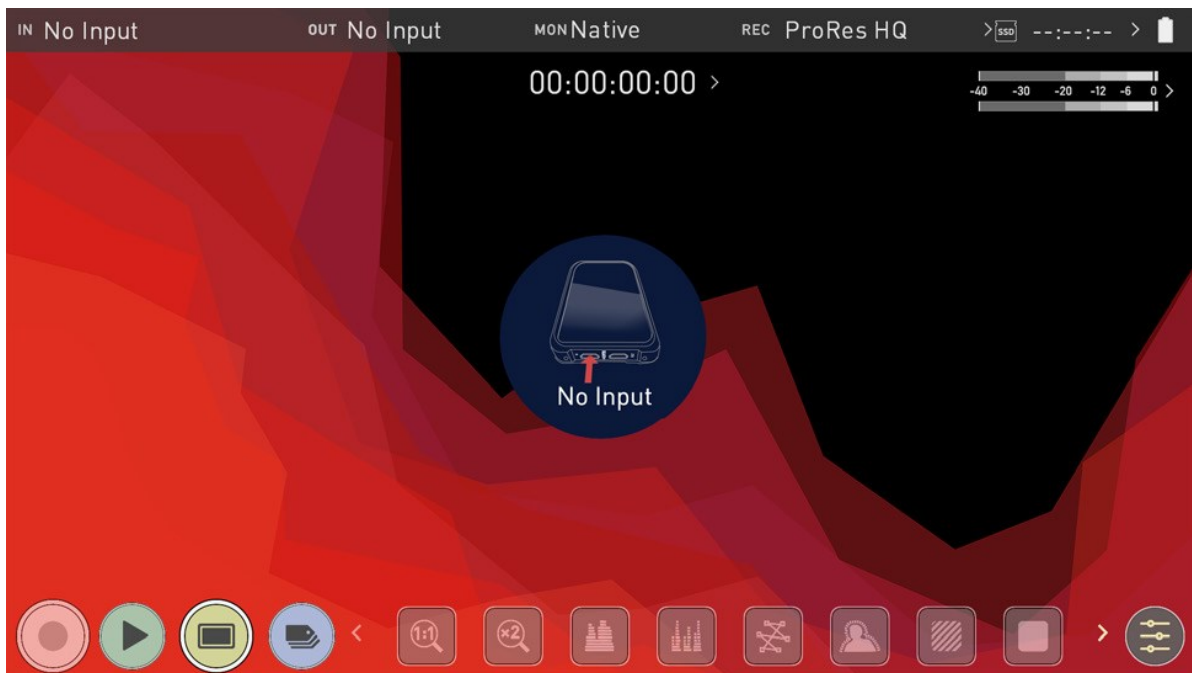

No Input / No Disk / No Disk Formatted

# SmartControl

SmartControl is a versatile set of functions used to control the starting and stopping of recording by automatic or external means. This section outlines the different methods to start and stop recording.

NINJA V Start and Stop record control can be triggered by the following methods:

1. Home Page Touch Screen
2. HDMI Rolling Timecode trigger
3. HDMI Camera trigger
4. Via LANC for Sony and Canon Cameras
5. Via LANC serial port



*Some cameras perform optimally when triggering from the camera and not the recorder.*

## Home page Touch Screen

NINJA V Start and Stop record control can be triggered by pressing REC (Record)



and STOP to end recording



## HDMI Rolling Timecode Trigger Record

If the camera is in Record Run mode, recording can be stopped or started by a moving Timecode via HDMI. When enabled the camera and the NINJA V will start and stop recording simultaneously.



Rolling Timecode trigger is for use in older cameras with TC only and no trigger. If your camera is set to FREE RUN this trigger will start recording immediately. Please be aware that not all cameras have Start/Stop flags for triggering record, especially older cameras. In such cases rolling trigger in REC RUN will need to be used to trigger recording automatically at the same time as the camera starts recording.

## HDMI Camera Trigger Record

The HDMI Camera trigger is available for supported cameras. There is a flag within the digital signal that lets the NINJA V know the start/stop record has been pressed on the camera; in turn this will trigger the NINJA V to start/stop recording at the same time as the camera.



# Understanding HDR and Log

The first step in HDR is to recognize you have a HDR scene. Look for a good range of contrast across the brightest and darkest parts of your image and also across the color and tonal range as each color also contains its own brightness or luminance information.

Secondly ensure you are sending a Log signal into the NINJA V so that you are recording the HDR Log information. For more information refer to the "Camera Output" on page 102 section.



Now you are ready to capture Log and simultaneously use ATOMOS 10 image processing to preview the final HDR result in the field, rather than dealing with the washed out look of Log for critical exposure decisions.



The main impact of HDR is apparent in the specular highlights and bright areas. The areas that would have previously been 'blown out' will now contain visible detail and information to enhance your content. HDR provides more headroom allowing you to show more detail. Experimentation with increased exposures is encouraged.

ATOMOS 10 HDR uses an in depth understanding of each Log curve and combines it with the control of the panel processing and backlight in order to apply an increased brightness to the highlight areas of the scene.



*Alongside the physical light in the scene, the faster your lens the greater the level of brightness you'll have to play with. Choosing a Cine-style lens or those with a de-clicked manual aperture can provide increased flexibility over photo lenses that use an electronic control aperture.*

The AtomOS 10 monitoring mode allows the processing engine of the NINJA V to display the High Dynamic Range capabilities of a Log gamma input. HDR monitoring in ATOMOS 10 is the result of the research and development by ATOMOS that allows control of all aspects of the monitor through image processing to deliver the unclipped beauty of specular highlights through natural, vibrant colors with a result that allows you to simply shoot what you see. When the scene in front of you and the picture displayed on the Ninja look similar, your exposure should be correct but use in conjunction with the waveform monitor to verify.

One of the key elements to understand is that if your camera can shoot in Log then it can already capture more dynamic range than you can display in SDR. Log preserves the high-light information by applying a Logarithmic curve to compress the additional stops of dynamic range to fit in to the Rec.709 standard. The image appears washed out and desaturated as each pixel contains more brightness information than SDR can display, if it were to do this it would be brighter than 100% Rec709 and so be clipped. This is illustrated below:



## Log Curves & Dynamic Range

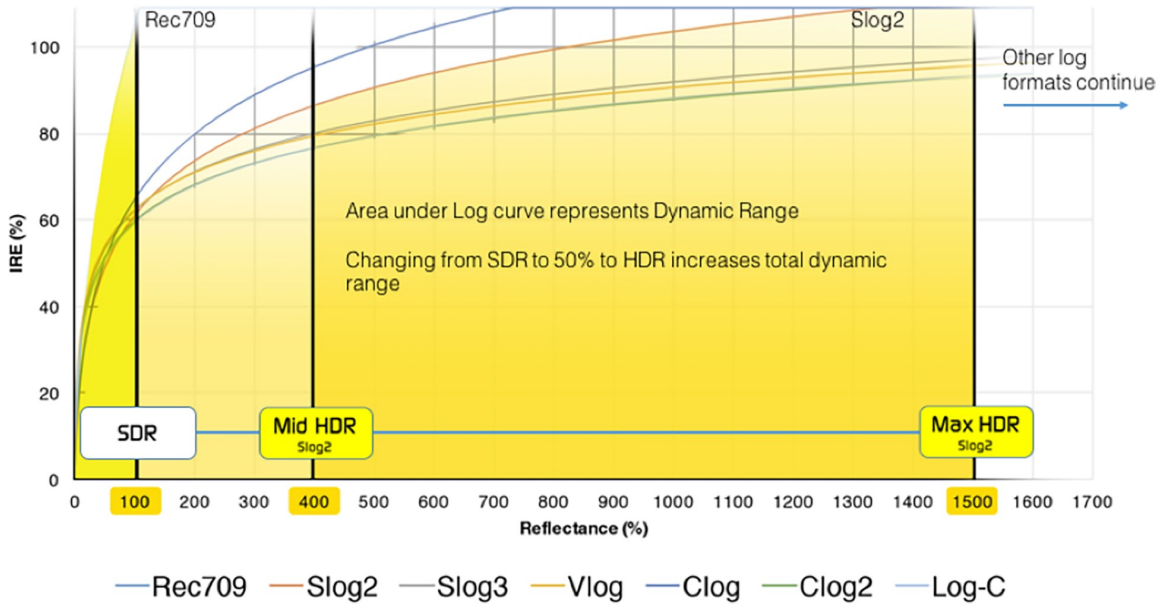

# File Recovery

The NINJA V continuously writes to disk while in recording mode. If the power fails or the drive is removed accidentally all but the last few seconds of the clip can be recovered.

In the event of an interrupted recording, when you restart the NINJA V, or enter playback mode, you will be presented with a menu that gives you the option to recover immediately, or recover it later.

If you select recover later, every time you put the disk in, or start up the NINJA V, the same menu will appear to prompt you to recover the file that did not close properly.



*If the drive is broken, or has become corrupted, then we will not be able to recover the file and we recommend that you try third-party hard disk recovery software.*

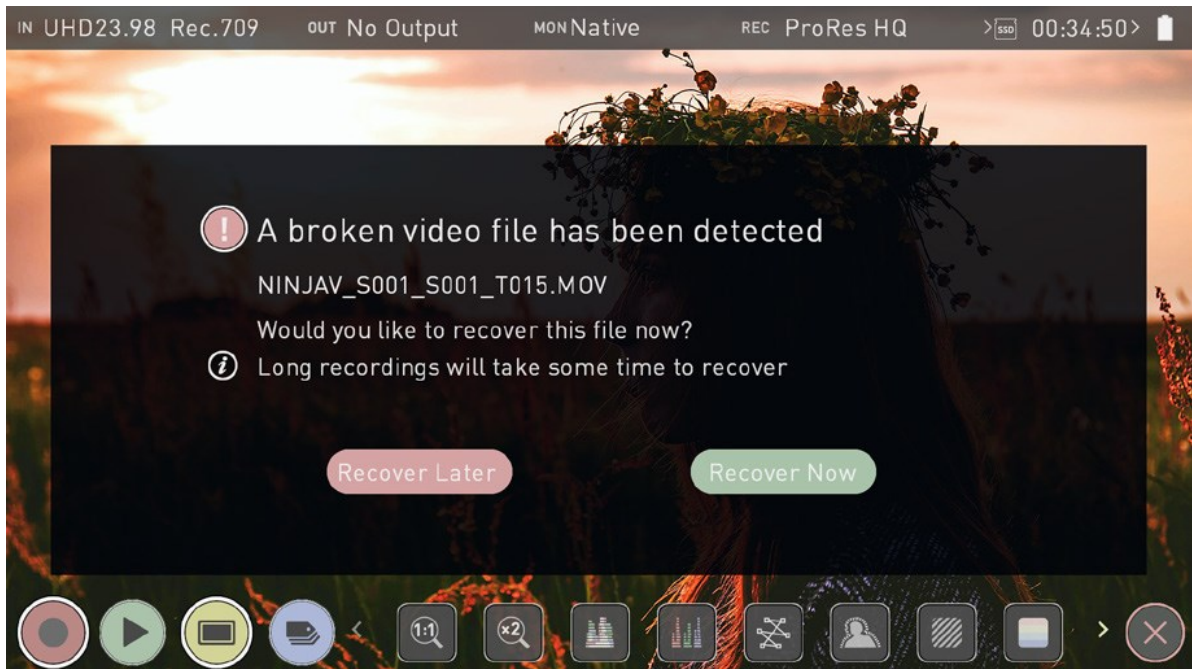

# Monitoring Features

ATOMOS 10 features a new and improved layout of monitoring tools that are displayed at the bottom of the Monitoring screen. Tapping the yellow MON icon will display or hide the monitoring tools. To reveal all Monitoring features, swipe the monitoring icons to the left. They will behave in a carousel like manner, where you can swipe left and right to access any of the features.

Some of the monitoring tools help you to assess the exposure and focus of your image. Other tools include frame guides, safe areas, anamorphic de-squeeze, frame grab and onion skin.

Tapping on the icons will enable/disable the feature, and in some cases will cycle through the options. Many of the tools can be used simultaneously to assist with focus, exposure, framing and more.



*Monitoring Features do not affect your recorded file and can be turned on and off, or adjusted whilst recording.*

## Monitor Mode / Features



## Monitoring Features Activation Icons



### Luma Waveform:

A great way to visualize the dynamic range of your image.



### RGB Parade:

Monitor the level of red, green and blue from an input source.



### Vectorscope:

This is useful for checking if an image is under or over saturated.



### Focus Peaking:

Ensure your recordings are always in focus.



### Zebra Pattern:

Use Zebra to check exposure and set exposure levels.



### False Color:

A visualization exposure across the image



### Blue Only Exposure:

Observe the noise content of a video image



### Zoom 1:1:

Punch in and check critical focus



### Zoom 2:1:

Toggle 2:1 to magnify the screen.



### Frame Guides

Cine, TV and Social frame guides



### 9 Grid

Overlays a 9 grid over the image to assist with composition according to the rule of thirds.



### Safe Areas

Action area and title safe areas displayed.



### Anamorphic Desqueeze

Allows you to see a correctly squeezed image when using anamorphic lenses



### Frame Grab

Allows you to capture lossless PNG frame grabs during recording and playback.



### Onion Skin

Allows you to layer frame grabs and other images on top of the video feed whilst in the Record and Playback modes.



### Settings

Press to access settings for monitoring tools



*The Monitor Features will only be illuminated and available if there is an input signal detected.*

# Zoom

Zoom mode enables you to punch in and check critical focus



1:1 Toggle to display 1:1 pixel mapping. The indicator box shows the location of the screen you are viewing. 4K 1:1 shows 1/4 of the 4K UHD image.



2:1 Toggle to magnify the screen. The indicator box shows the location of the screen you are viewing, and you can move the zoomed location by dragging across the screen or selecting a portion of the indicator box. 4K 2:1 shows 1/16 of the 4K UHD image.

# Waveform (WFM) and Vectorscope

These traditional scopes provide a visual representation of your image. You can customize the settings for Waveform Monitoring in the "Waveform tab" on page 316 of the settings menu.

## Luma Waveform

The Luma or Luminance Waveform is a great way to visualize the dynamic range of your image, allowing you to protect exposure of both your highlights and shadow detail. It's particularly useful when shooting with a low contrast LOG curve and works in perfect partnership with HDR to illustrate and highlight the clipping point to allow you to correctly expose your image.

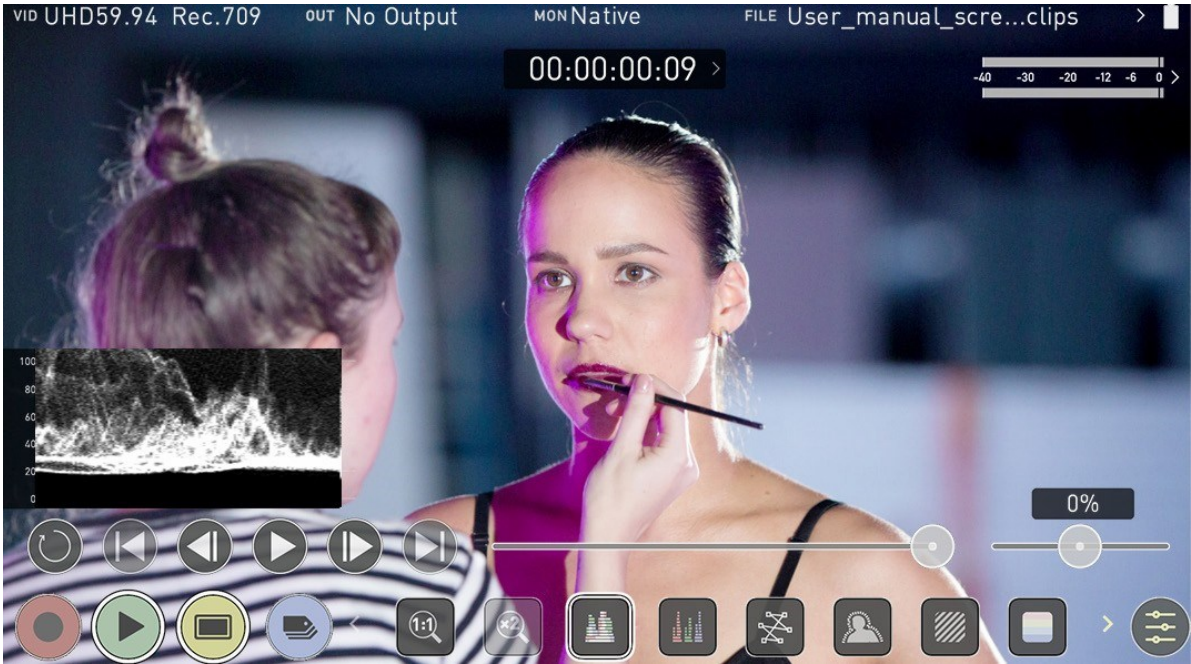

## RGB Waveform

RGB Waveform will monitor the level of Red, Green and Blue from an input source. The RGB channels are displayed side by side and each channel color is shown under the corresponding waveform. This can be used to check the white balance. Just point the camera at something white and the Red, Green and Blue levels should match if white balance is setup correctly on the camera.

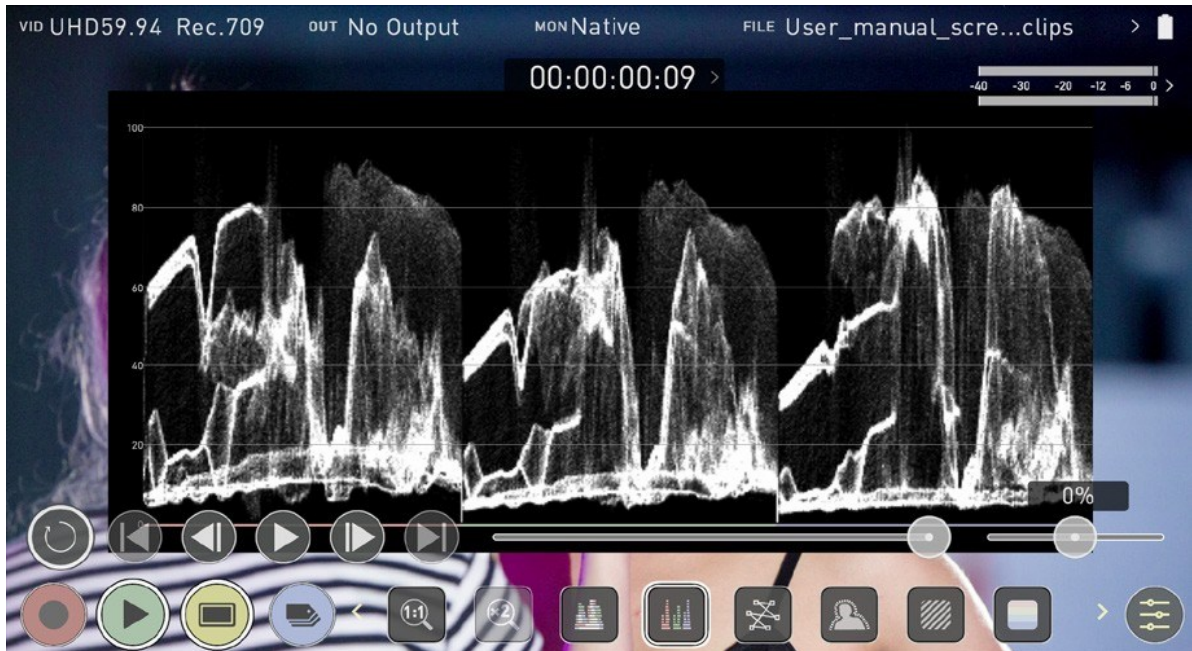

*The Waveform Monitor will remain on screen when hiding the overlays ensuring the focus remains on calibrating your image. If the MON button is pressed the WFM will move in to the bottom icon line up.*

## Vectorscope

The Vectorscope display shows color information of hue (shown as a phase vector), and saturation (measured by outward distance from the center). This is useful for checking if an image is under or over saturated and for calibrating multiple cameras to ensure greater consistency between shots.



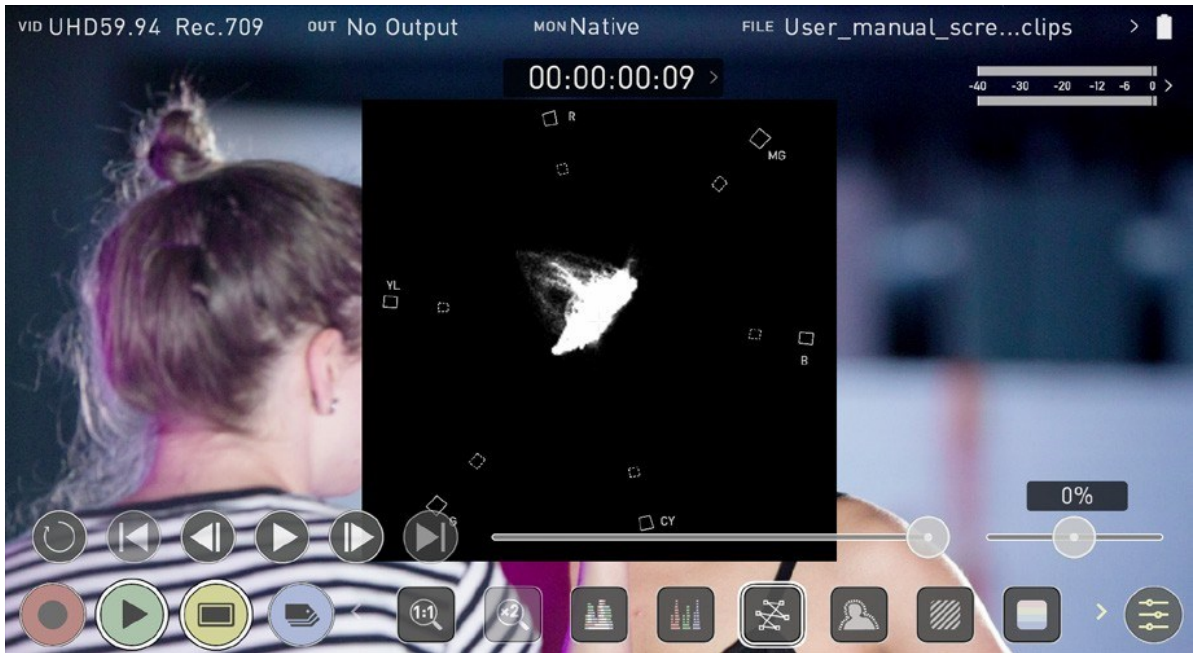

# Focus Peaking, Zebra and False Color

ATOMOS 10 features monitoring tools that help with making your shot picture perfect. Easily access Focus Peaking, Zebra, False Color and Blue Only Exposure to check image is in focus, noise free and correctly exposed. Options for safe area/ title area markers along with aspect ratio markers and anamorphic de-squeeze functions are also available.

## Focus Peaking

The focus peaking feature provides you with visual guides that enhance the areas in your shot that are in focus. The parts of the image that are in focus are highlighted by the selected color. You can customize the settings for focus peaking in the "Focus Peaking tab" on page 317 of the settings menu.

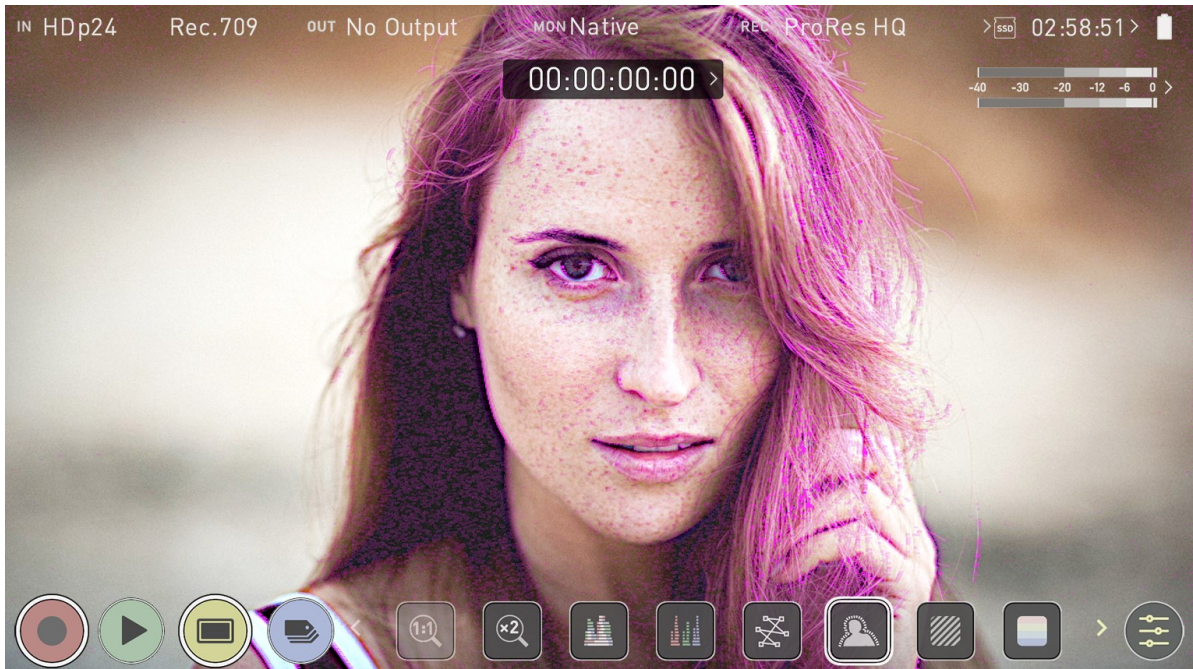

## Zebra

The Zebra feature overlays a diagonal pattern over the parts of the image that are exposed  $\pm 5\%$  of the target level set. This allows you to see at a glance, where parts of the image have reached a certain exposure level. You can customize the settings for the zebra function in the "Zebra tab" on page 320 of the settings menu.



## False Color

The False Color feature allows you to quickly expose your image by seeing an overall representation of brightness grouped into meaningful colors.

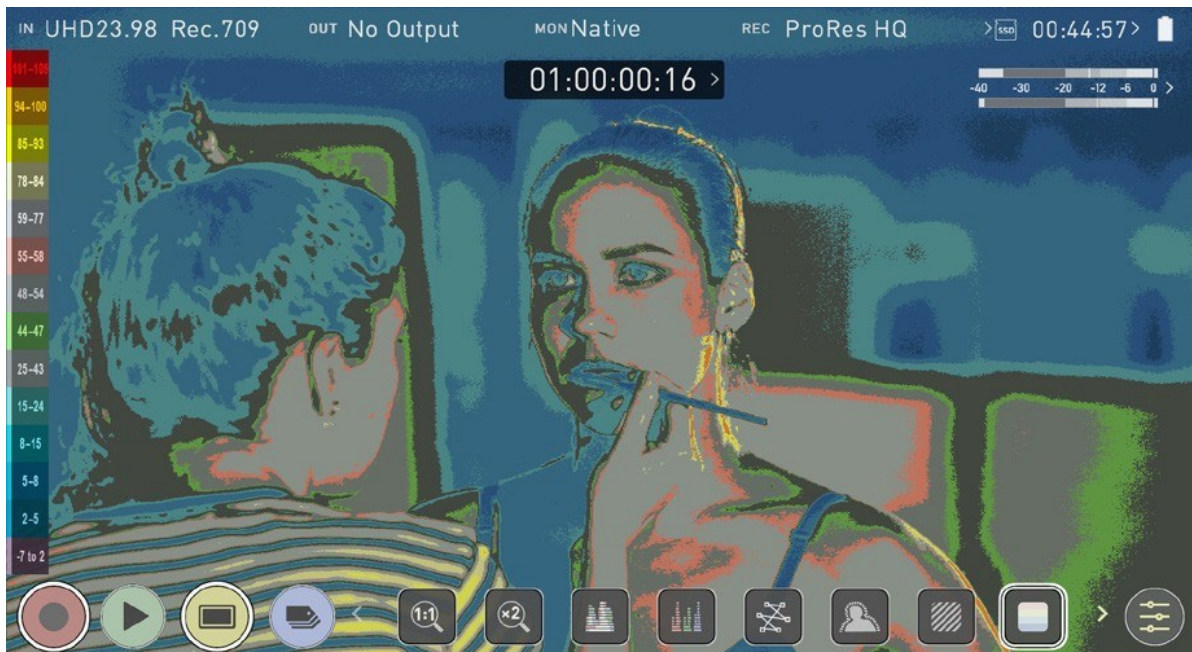

## False Color Scale

The False Color Scale on the left-hand side of the screen is a legend that correlates brightness values in the image with specific colors. The numbers in this scale represent the IRE %. As an example, mid grey is present between 44-47 IRE (green), underexposed footage is -7 to 2 IRE (purple), and overexposed footage is from 96-109 IRE (bright orange).

## Blue Only Exposure

Blue only displays a greyscale image based on the blue channel of the input signal. This is useful to observe the noise content of a video image as sensor noise is most visible in this channel.

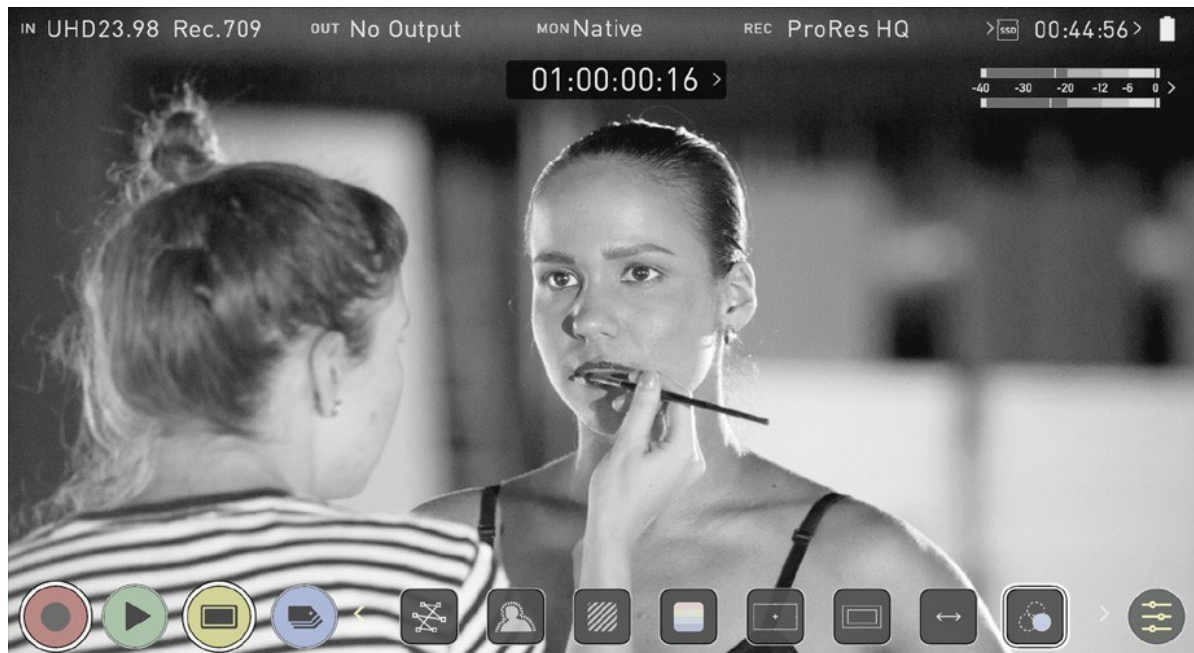

# Frame Guides, Safe Areas & Anamorphic De-Squeeze

ATOMOS 10 has advanced frame guides and safe areas. You can select from common cine, social or TV frame guides or set a custom frame guide. The aspect ratio markers are very useful with the Anamorphic De-Squeeze tool to preview crops that could be made in post.

## Cine and Social Frame Guides



Tap the Frame Guides icon to enable or disable the currently selected frame guide. You can select the frame guide to be used or enter a custom frame guide in the "Frame Guide tab" on page 333 of the settings menu.



## Safe Area Guides



Action safe area and title safe areas are proportional to the selected frame guide based on SMPTE standards. To turn on the safe area markers tap the Safe area icon once for the Action area and again for the title safe area.



*The Safe Area/Grid Lines will still be visible when tapping the center of the screen to hide the overlays.*

## Anamorphic De-Squeeze



Allows you to de-squeeze images when monitoring content filmed with anamorphic lenses. Tap the de-squeeze icon to cycle through the options to select the amount of de-squeeze required, so that the image on your NINJA V is not distorted.

The options include:

- 2x (4:3),
- 2x,
- 1.8x,
- 1.5,
- 1.33x,
- 1.25x



*Scopes are not available when anamorphic de-squeeze is activated.*





# Frame Grab and Onion Skin

## Frame Grab



This feature allows you to capture lossless PNG frame grabs in the NINJA V's native display resolution (1920 x 1080 pixels) during recording and playback.

### To capture a frame grab:

1. Whilst in recording or playback mode, tap the Frame Grab icon in the Monitoring Feature activation icons section at the bottom of the screen.
2. A tick will appear briefly inside the Frame Grab icon to indicate that a frame grab has been captured.



3. The captured PNG file will be saved to a Frame Grab folder on your recording media, which is automatically created when you capture your first frame grab.

## Onion Skin



This feature allows you to layer frame grabs or other images on top of your video feed, whilst in the Record and Playback modes.

### To load a frame grab or image as an onion skin:

1. Tap the Onion Skin icon in the Monitoring Feature activation icons section at the bottom of the screen.

2. The Onion Skin tab in the settings menu will open so that you can select the frame grab/image to be used. For more information on selecting the frame grab/image, refer to the "Onion Skin tab" on page 335 section.
3. The frame grab/image will appear on screen with position and transparency options. Tap on the screen to view the onion skin overlay without the icon box, and tap again to bring the icons back. Tap the arrow at the bottom of the icons to return to the Monitoring screen.

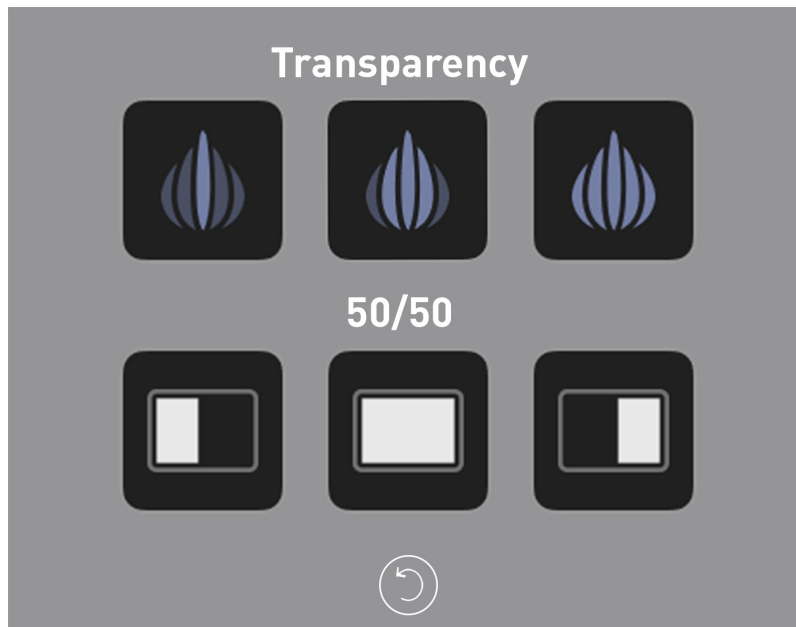

### **Onion Skin position and transparency options**

Tap the following icons to customize the position and transparency of the loaded frame grab/image:



#### **High Transparency**

The loaded image will be highly transparent. The video feed from your source will be highly visible.



#### **Medium Transparency**

A level of transparency that provides a balance between the low and high options.



### **Low Transparency**

The loaded image will be less transparent. The video feed from your source will be less visible.



### **50/50: Left**

Displays only the left half of the loaded frame grab/image over the top of the video feed from your source.



### **Full**

Positions the full width of the frame grab/image over the top of the video feed from your source.



### **50/50: Right**

Displays only the right half of the loaded frame grab/image over the top of the video feed from your source.



### **Return**

Return to the Monitoring screen.

## **Onion Skin Ready**

When a frame grab/image is loaded, the Onion Skin icon in the Monitoring Feature icon section will change to the icon below. Tap this icon to return to the onion skin view, which will display the last frame grab/image you used. Tap the arrow to return to the Monitoring screen.



To load a different frame grab/image, navigate to the "Onion Skin tab" on page 335 in the settings menu and follow the same process as outlined above.

## Settings Menu

This menu allows you to adjust the settings and behaviors of the Monitoring Tools that will be used when each monitoring tool is enabled. It also provides settings for LUTs, the display and monitor modes.

To access these settings, tap on MON in the Information Bar across the top of the screen. Alternatively, tap on the yellow settings icon in monitoring mode and then select the desired tab across the bottom of the page.



## Waveform tab

To access Waveform Monitoring settings simply tap on the Settings icon and select the Waveform Tab.

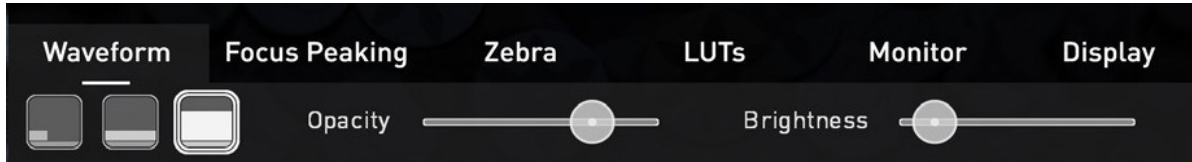

To change the size of the waveform, press on the corner icon, lower screen icon or full Screen icon. The display will update immediately.



*The size settings for the Vectorscope are limited to corner and full Screen.*



*To toggle between Waveform Monitor sizes of 1/4, 1/3 and Full Screen during monitoring, recording and playback, tap on the bottom left corner of the screen. You can also adjust the brightness and opacity of the waveform display whilst recording, monitoring or during playback.*

The Brightness slider directly controls the intensity of the waveform while the opacity slider adjusts the transparency values of the waveform display on screen. Experiment with these controls to achieve your desired monitoring setup.



# Focus Peaking tab

To access the focus peaking settings, simply tap the Settings icon and select the Focus Peaking Tab. These settings allow you to customize how peaking is displayed. There are multiple display modes and you can select the color and width of peaking indicators.

## Mode

Tap on these icons to switch between the focus peaking modes:



## Focus Peaking Color

This option overlays the focus peaking indicators on top of the color video image.

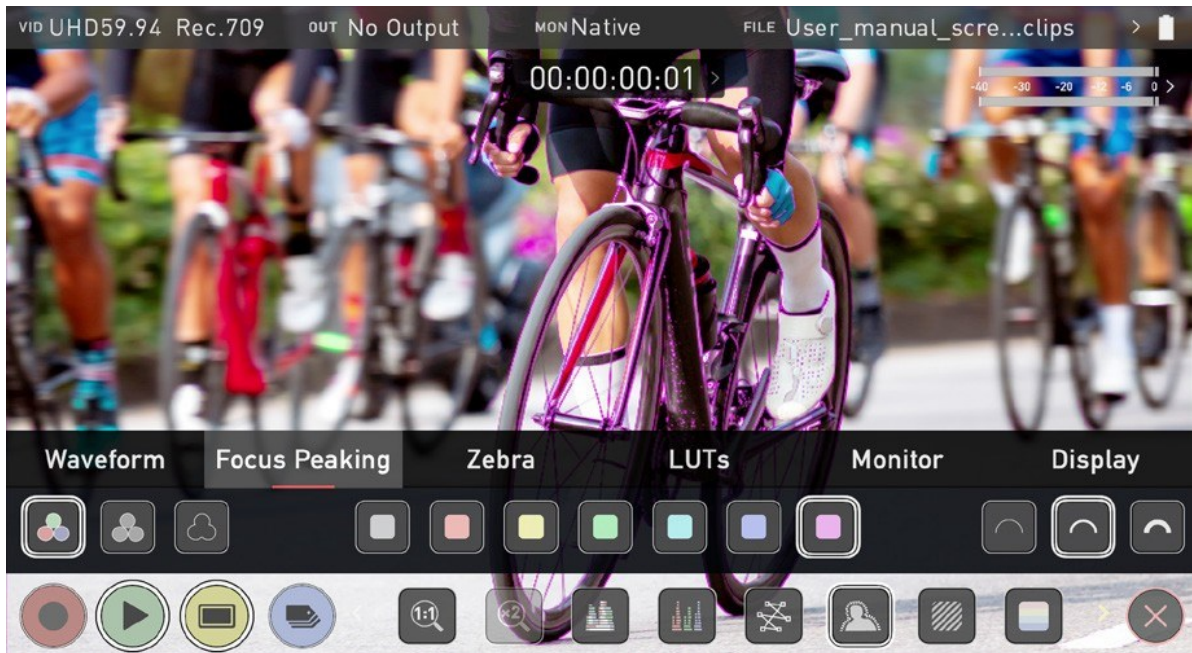



## Focus Peaking Mono

This option overlays the focus peaking indicators on top of a gray-scale image.

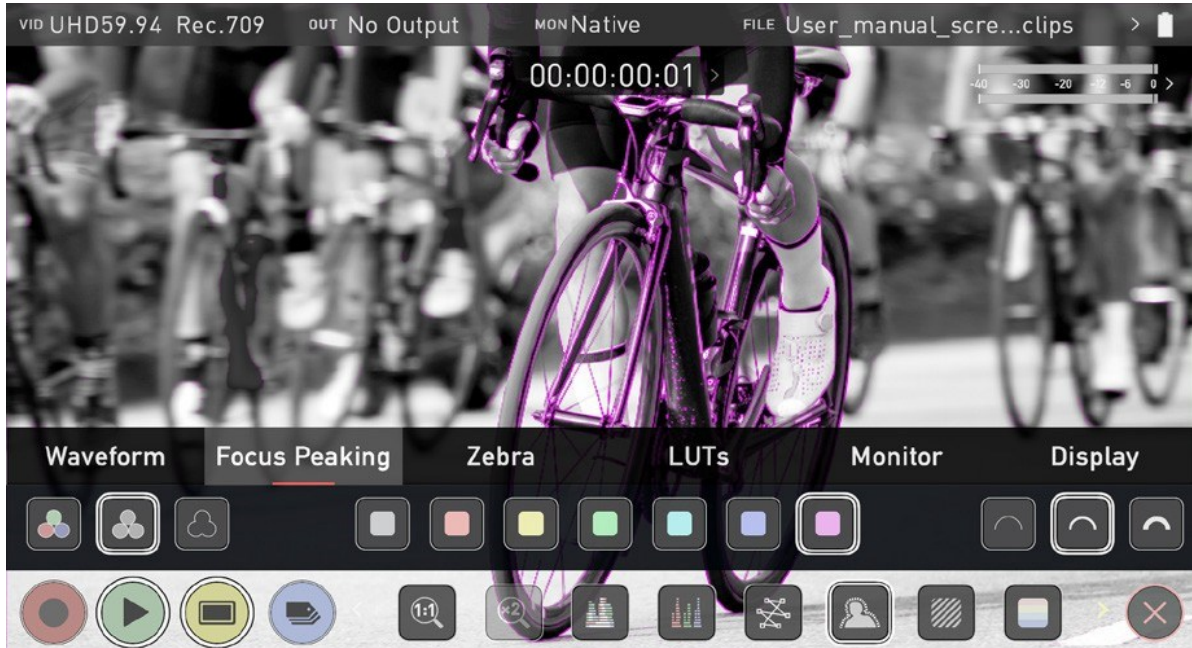



## Focus Assist Outline

This option overlays the focus peaking indicators on top of an outline of the image.

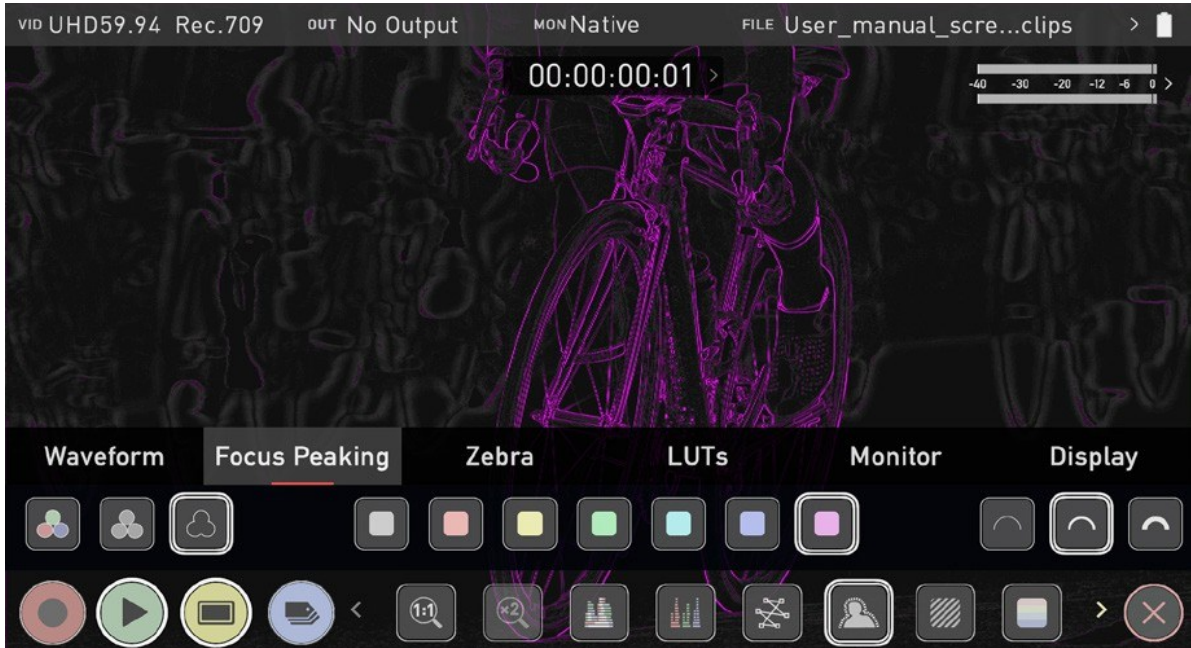

### Outline Color

Adjusts the color used for peaking. It can be helpful to adjust this color so that areas in focus stand out from the color of the background.



### Outline Width

Adjusts the width used focus peaking indicators on screen. Tap to select the desired width.





## Zebra tab

To access the Zebra settings, tap the Settings icon and select the Zebra Tab.

### Zebra Threshold

These settings allow you to select an exposure level in your image where you want the Zebra indicators to appear. A setting of 95-100% is commonly used to indicate areas of the image that are close to overexposure or that are overexposed. The Zebra threshold value can be adjusted by moving the slider left or right.

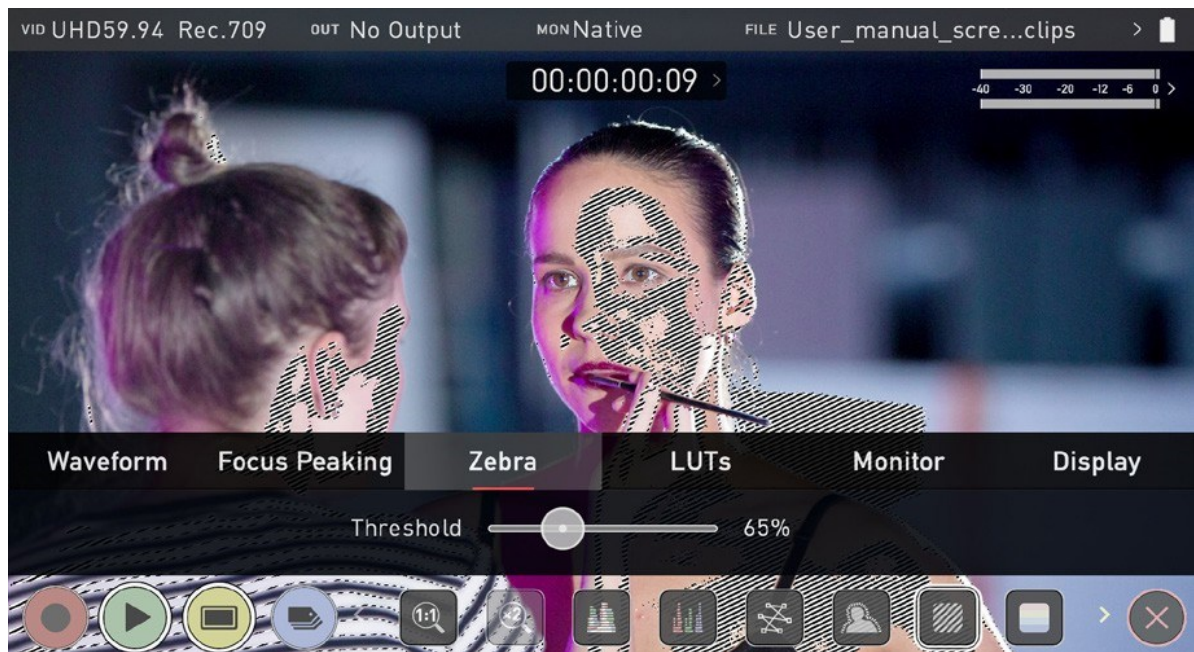

## LUTs tab



To access the LUT settings, simply tap the Settings icon and select the LUTs Tab.

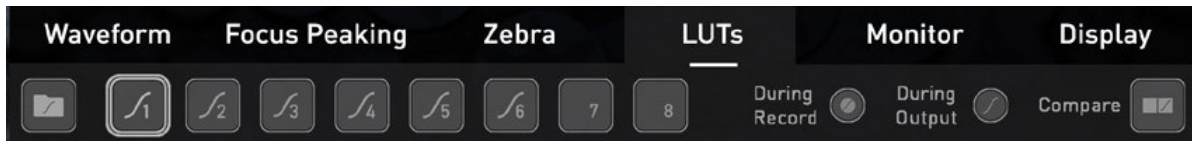

A LUT or Look Up Table is a table that transforms the color response and as such adjusts the 'Look' of the input. 3D LUTs have a combination of three inputs defining the combination of R, G, and B values allowing for adjustment of not only color but also gamma and gamut. LUTs can also be used to monitor the input in a specific color space or more creatively to create a specific 'look' such as film stock emulation or to match cameras.

It's worth noting that not all LUTs are equal and the majority of LUTs are designed to work within the boundaries of REC.709. This means that whilst they may apply the color adjustments you are looking for they may also effect the luminance of the image and in which case these LUTs should only be used for delivery of content designed to be viewed in REC.709 or SDR.

If you are working with 3D LUTs you can use color correction applications, as well as applications like Davinci Resolve, Photoshop or dedicated applications like LUTCalc. To create your own custom Looks that can then be imported to your ATOMOS device. They can provide a great base or primary grade that allow you to apply an instant look to your footage.

ATOMOS support 3D LUTs in the industry standard .CUBE format and provides 8 LUT memory slots for you to load your LUTs into. 1D LUTs are not supported and will need to be converted via 3rd party software to be imported.

### How to import LUTs to your NINJA V:

1. Copy the .CUBE files onto your media using a computer and compatible dock.
2. Tap on MON in the Information Bar across the top of the screen to access the monitoring tools settings and select the LUTs tab.
3. Tap on one of the numbered slots to select it. Slots that already have a LUT loaded will have a curve next to the slot number whilst empty slots will not.

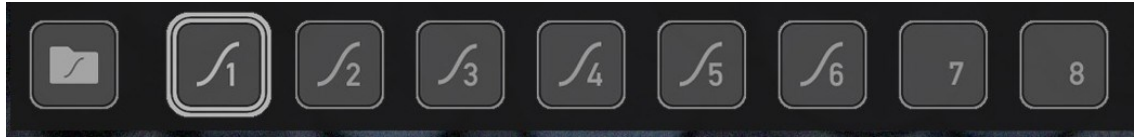

4. Tap on the folder icon to access your media.



*If you select a slot that already has a LUT loaded, you will be asked to confirm the fact that you want to overwrite the loaded LUT when you tap on the folder.*

5. Navigate through the disk file system to the LUT file to be uploaded, and tap on the name of a LUT to select it. A second tap on the name will import the LUT to the selected slot.

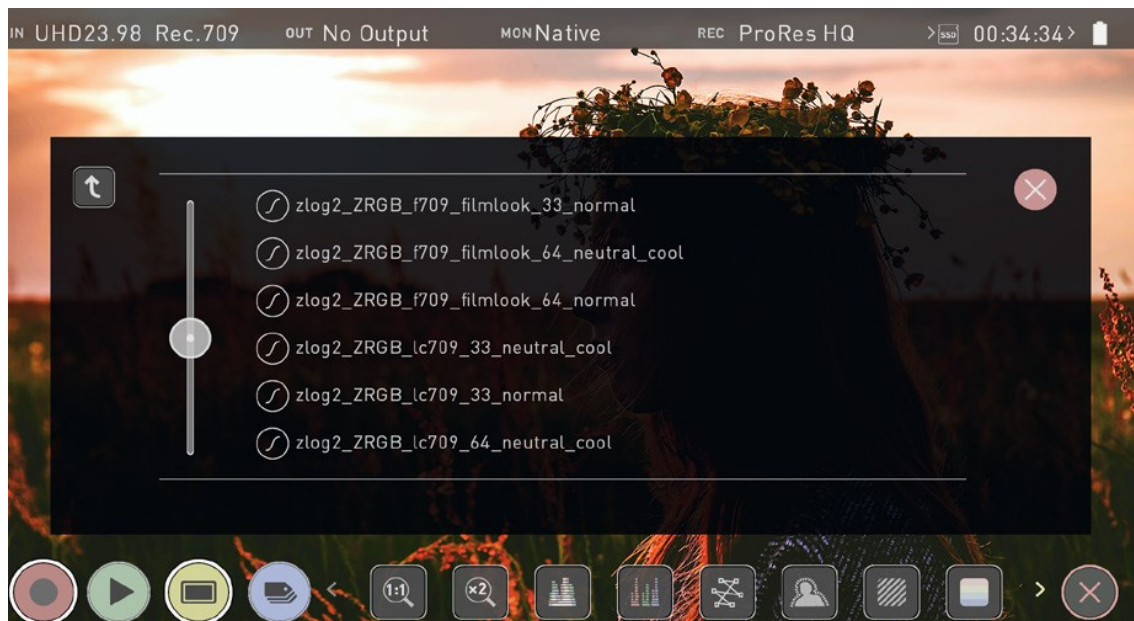

1. A progress bar will appear on screen whilst the LUT loads.

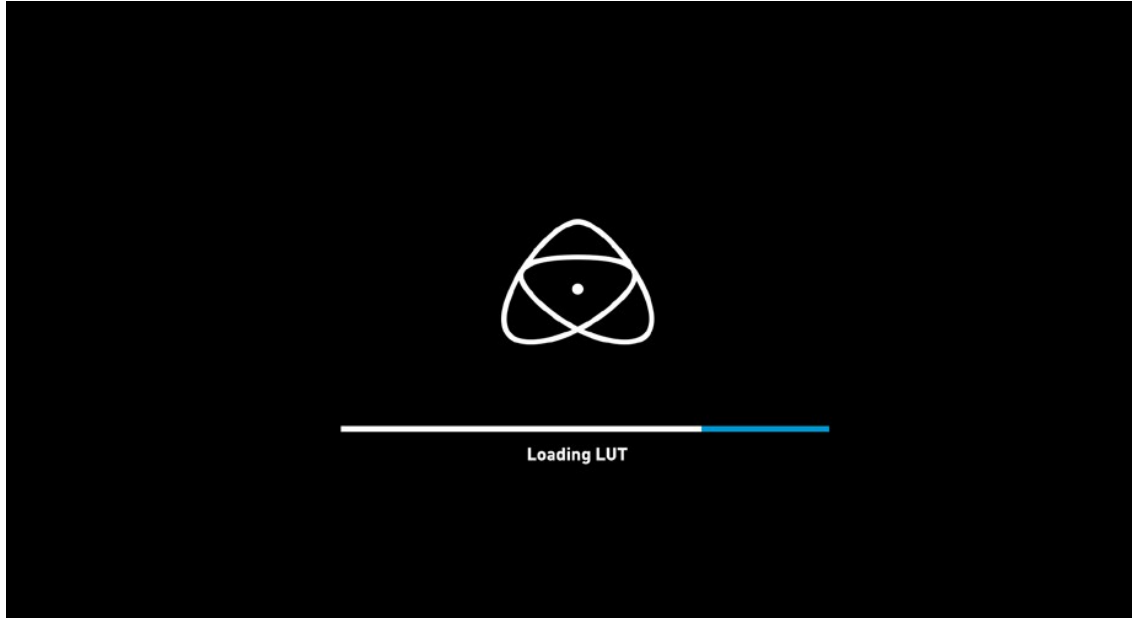

2. The LUT has now been loaded and will be selected by default.
3. Repeat the process to store up to 8 LUTs on your NINJA V.



*Once a LUT is loaded into your NINJA V, it cannot be deleted. Loading LUTs into a slot that already has a LUT loaded, will overwrite the loaded LUT.*

## **How to apply a LUT to your image:**

1. Tap on MON in the Information Bar across the top of the screen to access the Monitor Mode menu and select the LUTs tab.
2. Tap on one of the eight slot numbers to select a LUT to be applied to the display. Tapping on slots that have LUTs loaded will preview the name of the selected LUT (above the Menu bar).



*Slots that have a LUT loaded will have a curve next to the slot number whilst empty slots will not.*



3. Tap on the Monitor tab to open the the Monitor Mode menu.
4. Tap on the LUT icon to apply the selected LUT to your image. The name of the currently selected 3D LUT will be displayed next to the LUT icon.



*The selected LUT file name will display at MON in the Information bar when applied to the image.*

## LUT Processing

In the LUTs tab, the settings allow you to choose how the LUT will be applied:

- During recording
- During Output
- Compare

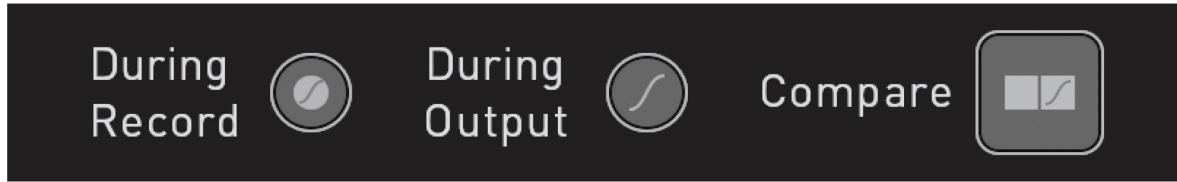

### **During Record**

If this option is selected, your NINJA V will bake the LUT look into the recording. When enabled, a CUSTOM LOOK icon will flash in the top corner of the monitor and the LUT cannot be activated during recording to avoid any potential issues with the recorded content.



*Baking a LUT into your recording cannot be undone in post-production, so we advise that you consider your workflow before the use of this option.*



*Baking the LUT into your recording is not supported when recording with the ProRes RAW codec.*

### **During Output**

**OUTPUT LOOK** – With this option, the selected LOOK is also applied to the HDMI loop out of the NINJA V. This will allow for instant preview on a larger monitor or to be used with a wireless sender. This function can also be combined with the down convert option that can be found in the input menu.

### **Compare**

During color management it's likely that you may want to review a number of LOOKs and even compare them to the Native Video Source. Tapping the Compare option will apply a 50/50 vertical screen split that will show both the Natural Source Video and the selected LOOK of the LUT.

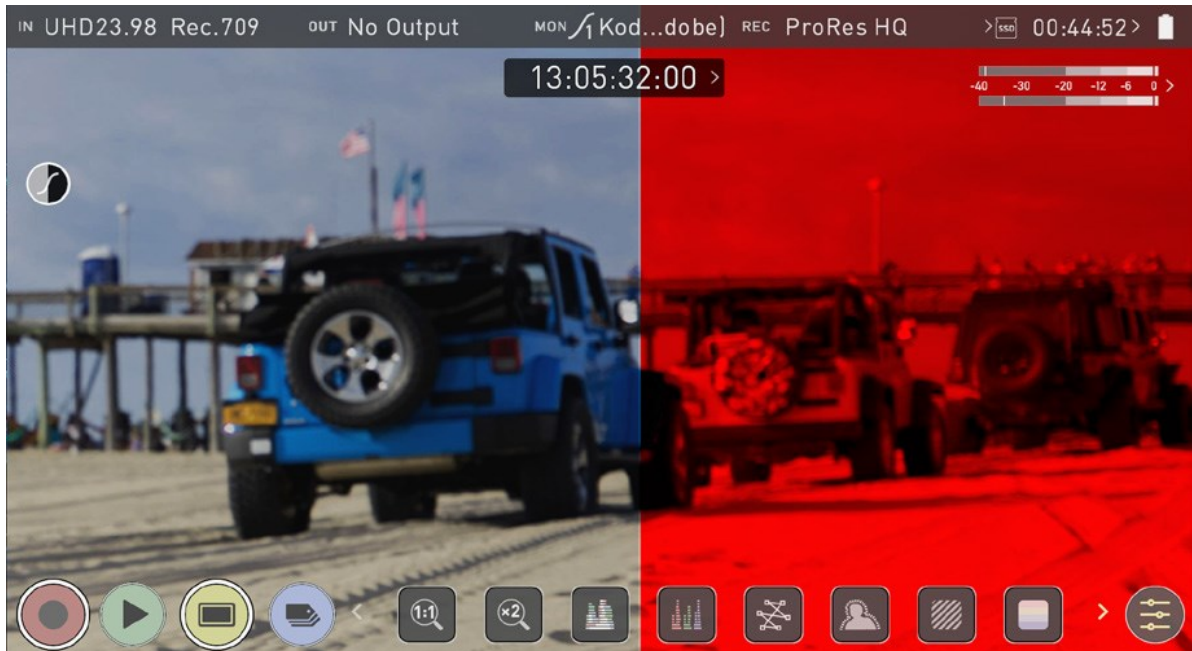

*Please note that activating the 50/50 preview will also be applied to the Loop out and is not available when LUT is set to record.*



*Remember that you can remove all overlays by simply tapping in the center of the screen. Tap again to reveal the overlays.*

## Monitor tab

To enter this menu, tap on MON in the Information Bar across the top of the screen. The Monitor Mode menu will open on the bottom of the page. Alternatively, tap the yellow Settings icon and select the Monitor Tab.



*Before entering into the operation of HDR monitoring, it is important to understand the background of HDR. We advise that you read the ATOMOS HDR Guide to familiarize yourself with the key terms and differences between the existing Rec.709 standard dynamic range (SDR) and the way we view images in High Dynamic Range (HDR).*



### Using Standards - Native / Rec.709 / HLG / PQ

ATOMOS 10 uses predefined settings to display your video when viewing in HDR. On the left side of the screen are buttons that correspond with Native, Rec.709 (SDR), HLG and PQ (HDR) levels. For information on the LUT icon and using LUTs, refer to the "LUTs tab" on page 321 section.

Activating these buttons will display your video according to the levels indicated below, allowing you to adjust your exposure accordingly and take the guess work out of exposing correctly for HDR.





### **Native Video Source**

This option will display the video source without any processing and the NINJA V will behave as expected for a standard broadcast monitor. When connected to a camera this means the image you are viewing is the untouched camera output e.g.. a standard Rec.709 image or a Log image etc. A standard Rec.709 image will look correct and a Log image will look flat.



### **Rec.709**

With this mode selected the NINJA V will map from the camera gamma/gamut so that 100% linear IRE maps the panel's white (1000nits). Everything above is clipped.

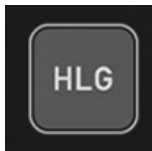

### **HLG (Hybrid Log Gamma)**

With this mode selected the NINJA V will map from the camera gamma/gamut so that 1200% linear IRE maps the panel's white (1000nits). Highlights are slightly compressed.



## PQ

With PQ mode selected the NINJA V will map from the camera gamma/gamut so that 2000% linear IRE maps the panel's white (1000nits). Highlights have more compression and look similar to HLG, but closer inspection will reveal more detail is visible in specular highlights.



*Your camera's dynamic range will determine how much more detail is visible between HLG and PQ modes.*

## Monitor Options

On the right side of the screen, the monitor tab provides options for the NINJA V



## Display Off

The Display off function allows for the screen to be turned off without affecting the operation of the unit. When enabled, the screen will turn off whenever you lock the display screen by tapping the power on/off button on the side of the unit. For more information refer to the "Best Practice" on page 19 section.



## **Tally**

The Tally light on the rear of the unit will still display red for record and the idle (green) status will be displayed on the front screen LED. If you have an ATOMOS CONNECT accessory attached, this will enable/disable the tally light on the rear of the CONNECT.



## **Flip Screen**

The Flip screen option allows you to invert the screen to meet your needs of operation.



*Whilst the screen is inverted, take note to respect the air flow and not to obstruct the cooling vents of the unit.*

# Display tab

To enter this menu, tap on MON in the Information Bar across the top of the screen or tap on the yellow settings icon in monitoring mode. Then select the Display tab on the bottom of the page.



This menu gives you the option to change the screen brightness by adjusting the slider when in Native, Rec709 and LUT mode. As you slide to the right the brightness will increase and when at 100% the image will be using the full 1000nits of the display. As with any electronic screen device increasing the brightness will increase the power draw and battery life will be effected accordingly.

Adjustments can also be made to the Lift, Gamma and Gain of the display. To make an adjustment, tap and drag the slider left and right.

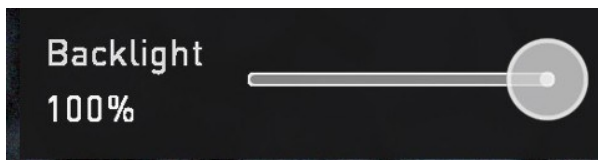

## Backlight

Adjust the strength of the backlight. Disabled during HDR monitoring

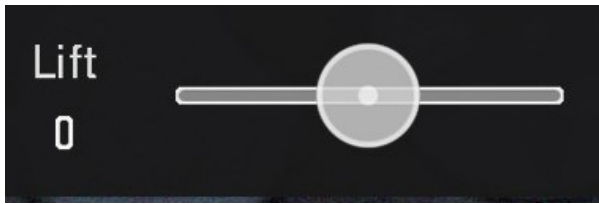

**Lift**

Increasing lift will brighten the image and lessen the shadows

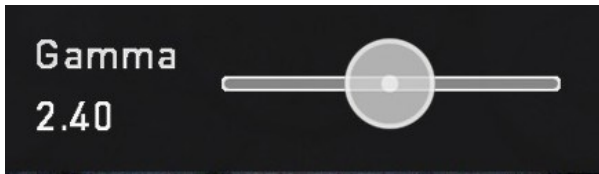

**Gamma**

Gamma control allows you to create darker and richer shadows. This may be useful when monitoring in bright daylight conditions.

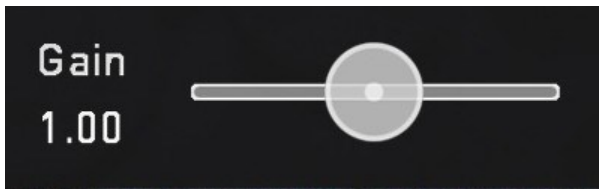

**Gain**

Gain will boost the image brightness and affect the highlights



**Reset**

Quickly return all values to default (Apart from the Backlight setting)

## Frame Guide tab

To access the frame guide settings, tap the Settings icon and select the Frame Guide tab. Tap on one of the displayed icons to select a frame guide.

Cine frame guides include:

- 16:9
- 2.4:1
- 2.35:1
- 1.9:1
- 1.85:1
- 4:3

Social frame guides include:

- 9:16
- 1:1
- 1.91:1
- 4:5

You can also select Custom, which allows you to enter your own aspect ratio.



### Setting a Custom aspect ratio:

1. Tap on Custom Ratio.
2. Use the on-screen keypad to enter your desired aspect ratio, then tap Save.
3. Tap on the Custom icon to select it as a frame guide, and close the settings menu.

4. The Frame Guides icon in the monitoring tools carousel will now display the word Custom. Tap this icon to enable or disable the custom frame guide you entered.



*Invalid Ratio will be displayed where the entered ratio is not supported.*

## Onion Skin tab

The settings in this tab allow you to select frame grabs or other images, for use as an onion skin layer on top of your source video feed.

### To load a frame grab or image as an onion skin:

1. Tap on Last Grab to use the last frame grab taken, or Last Used to load the last frame grab that you loaded. You can also tap on the folder icon to load an individual frame grab or image via the file browser. With the browser open, tap on an image to select it and tap again to load it.



*Besides using frame grabs captured with the NINJA V, you can also load custom 24-Bit PNG images (Alpha Transparency supported) in 1920 x 1080 resolution via the Onion Skin tool.*

2. The frame grab/image will appear on screen with position and transparency options. Tap on the screen to view the onion skin overlay without the icon box, and tap again to bring the icons back. Tap the arrow at the bottom of the icons to return to the Monitoring screen. For information on the transparency and position settings, refer to the "Frame Grab and Onion Skin" on page 312 section.

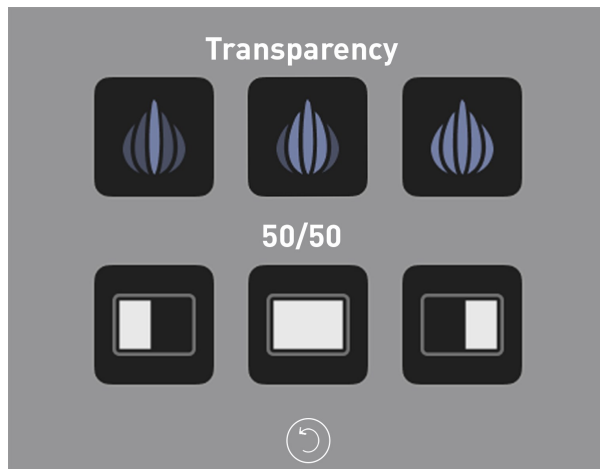



## Playback mode

Pressing the Play button switches the device into playback mode and the last clip recorded on to the drive will instantly begin to playback. Playback allows you to instantly analyze the content. This is key for establishing if takes are correctly focused, lighting has changed, or previewing recorded content with LUTs applied.



*The first time the Play button is pressed after recording a clip, the last clip recorded will playback. If you switch back to REC mode after doing this and press the Play button again, the file at the top of the file list will playback.*

Once within Play mode the complete Monitoring and Edit tool sets are available by tapping the buttons. Switch from Monitor to Edit tools by toggling the MON and EDIT buttons. Clips/Playlist can be selected by tapping the folder icon in the lower right of the screen, or skip to the next or previous clip via the on screen controls. Additional controls allow you to scrub through clips, set the playback speed and direction, as well as the ability to set the play mode to Loop.

All these functions can also be used in 'Playout' mode, and your footage can be viewed on a larger screen or monitor for review and appraisal. You can even apply Log curves and LUTs to your clips as they are played back.

## Playback Mode / Home



## Main Controls

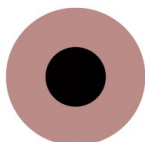

### **REC (Record):**

Jump to Record Home Screen



### **PLAY:**

Play and pause the current clip



### **MON (Monitor):**

Reveal/hide monitoring tools. Toggle on/off



### **EDIT:**

Reveal/hide edit tools. Toggle on/off



### **Settings**

Touch to access Playback settings and tools.



## Recorded Files

Browse recorded files

## Playback Controls

These controls become available during playback.



### Scrub bar

Scrub forward and back through the clip.

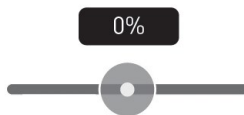

### Speed/direction control

The percentage slider allows for you to set the playback direction and speed. This is perfect for previewing high frame rate at half or quarter speed such as 60p at 30p in either forward or reverse directions.



### 2x/4x

Playback at 2x or 4x speeds both forward and in reverse.

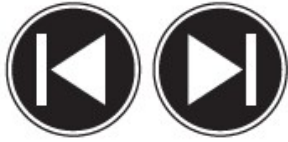

### **Next/Previous**

Jump to next or previous take.



### **Advance**

Whilst a clip is Paused these buttons have the ability to step the clip by 1 frame either forward or reverse to give you chance to analyze the clip in more detail, this is especially useful when combined with the 2:1 zoom function.



### **Loop**

Tapping this icon, you can put the clip into loop playback. In and out markers for loop can be placed and cleared using the edit tools. For more information, refer to the Edit section.

## **Playback**

One of the key elements of the NINJA V is the ability to utilize the monitor recorder as a playback and playout device for the content that has been recorded whilst maintaining the same visually lossless high quality images. NINJA V's playout capability also allows you to send the live and recorded footage out to a larger HDMI monitor or switcher.



## Recorded Files

Pressing the filename or folder button will bring up a list of clips available on the drive. This will show clip name (with Scene shot Take numbers) as well as resolution, codec and duration Tap to highlight a clip, this will show a preview of the first frame in the background. To play the selected clip touch the file name again. To play specific files you can also create a playlist. For information on creating a playlist refer to the "Playlists" on the next page section.



*When the playback content list menu is open, playback will automatically stop.*



*The codec for each clip is displayed in the white circle to the left of each clip's filename*

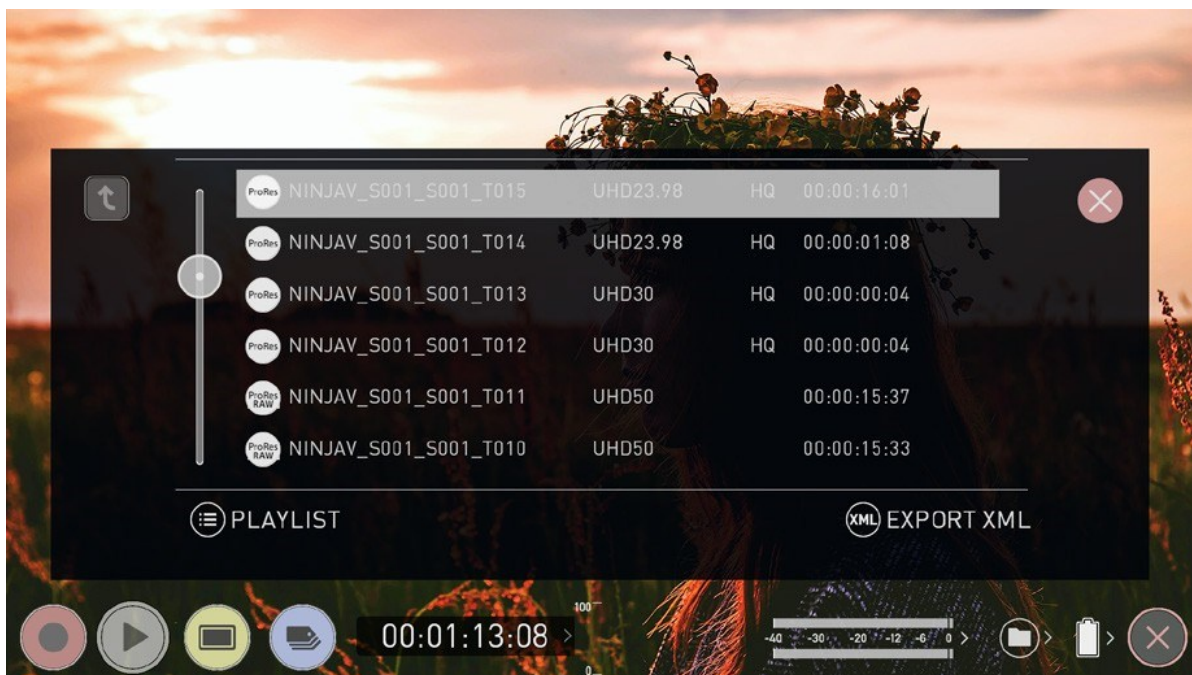

# Playlists

To increase the functionality and flexibility of the playback mode there is also the ability to create a Playlist.

## How to create a Playlist

To build a Playlist, open the Recorded Files folder, then press the Playlist button which will turn green and reveal the options available. To return to normal playback of all recorded materials, press the Playlist icon again to deactivate the playlist.



*All clips in the Playlist must have the same codec, resolution and frame rate.*



*The codec for each clip is displayed in the white circle to the left of each clip's filename*

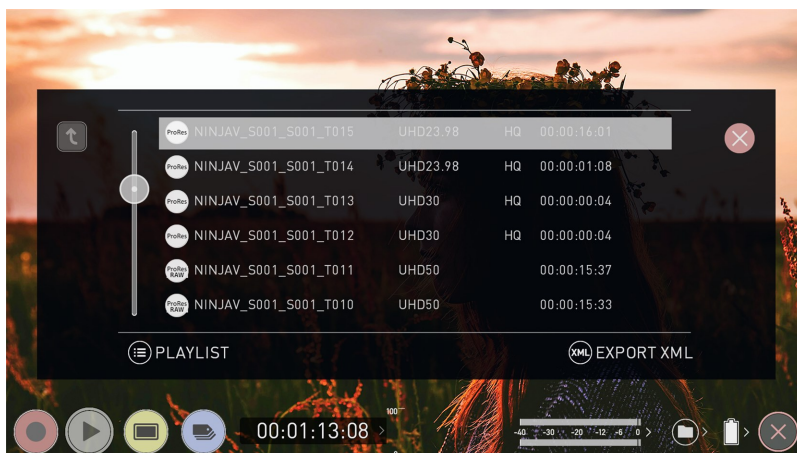

## Playlist Options



### Order

This icon lets you adjust the order in which clips playback. By default the order of recorded clips is based on their file names, with the last clip recorded at the top of the list. Tap Order to toggle the order that clips will be played back in.



### Tags

Tap this icon to cycle through the following options to select what will be included in the playlist:

#### All

Plays all clips on the disk.

### **Selected**

Plays only those clips selected

### **Favorites**

Plays only the clips that are tagged as favorites.

### **Combined**

Plays only the clips that are tagged with favorite and the selected clips



*The duration of each clip in the playlist is combined together and are shown on the scrub bar in playback controls. A white vertical line indicates the start and end points and clips will seamlessly playback across those selected to be in the playlist.*

## **Codec Playlist**

You can select which clips are played back by toggling the available codecs. Only clips of the same resolution, frame rate and codec are supported. The resolution and frame rate is indicated in the bottom right corner of the screen.



## **Favorite Playlist**

The cut tag edit points can be combined with the favorites Playlist allowing the in and out points that have been created within the clip using the favorites flag to be used as sub clips within a Playlist. This means that if in and out points have been marked on a clip only those sections of the clip will play when used in a favorites or combined Playlist. Close attention should be paid to the order icon as this also relates to the sub clips as the run down order will play the last sub clip first in the Playlist.





*Whilst a Playlist is in operation further metadata tags can not be applied to these clips.*

More information about using the In and Out points, tagging and XML Export is available in the "Using Edit tools during recording, playback and monitoring" on page 356 section.

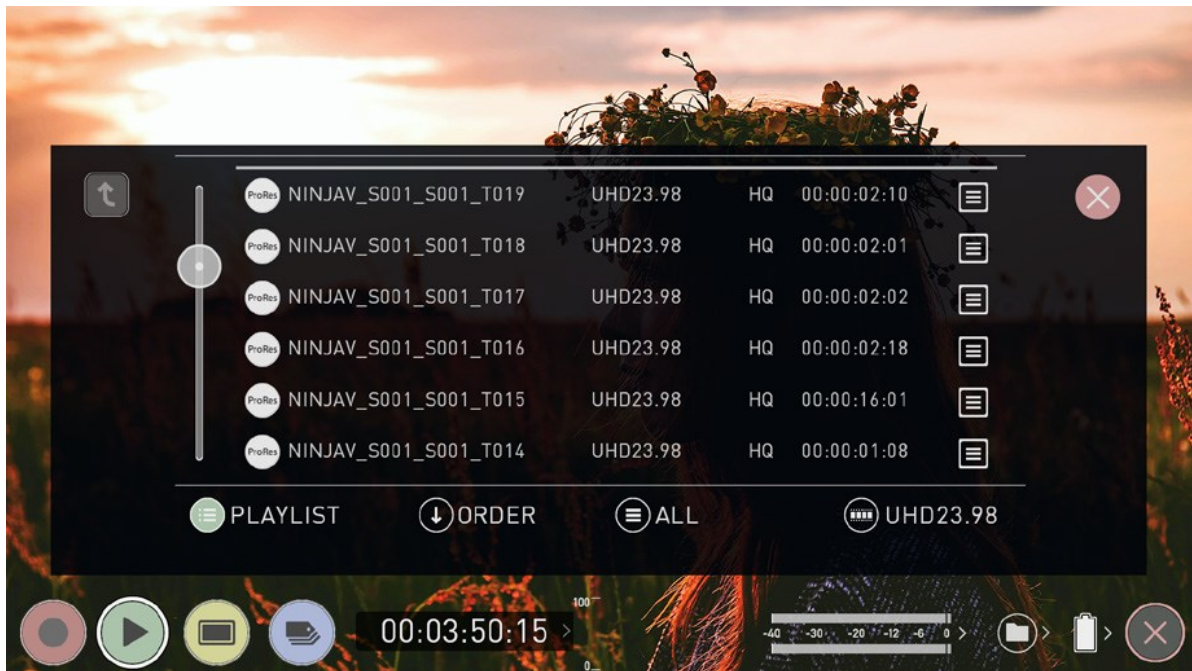

# Video Format menu

This menu appears when you tap on VID in the Information bar across the top of the screen. It contains information about the settings used in recording the clip.



## **Format:**

Displays the resolution and frame rate used in recording the selected clip.

## **Codec:**

Displays the codec of the current clip.

## **Compression:**

Displays compression settings for selected codec.

## **Length:**

Displays the total length of the clip.

## CAMERA OUTPUT

### Log/HDR (On/Off)

Tap to enable/disable HDR image processing inside the NINJA V.

### Camera

Tap to scroll through to the manufacturer of the camera providing the input. Options include: Sony, Fujifilm, Canon, Panasonic, ARRI, RED, JVC, Leica, Nikon, ZCAM, Olympus, OMSYSTEM and Rec.2100.

### Gamma

For each manufacturer there may be a number of different Log curves available and you can scroll through to the correct selection by tapping the Gamma icon.

### Gamut

Select the Color Gamut of the input. Ensure that this matches the input of the camera to ensure accurate monitoring.



*Gamut options are not applicable to all cameras*

### Playback Auto HDR (On/Off)

Engage this switch if you are feeding HDR images to the NINJA V from a camera or games console that supports HLG or PQ HDR output directly, using the appropriate metadata flags. If you are feeding Log video to the unit be sure that this setting is off. Tap to enable or disable the setting.

# Playback - Output Menu

This menu provides information and settings for the signal that is being output from your NINJA V over HDMI and SDI. The Output menu that appears whilst in Playback mode is identical to the Output menu that appears whilst in the Recording and Monitoring modes. For more information on these settings refer to "Output Menu" on page 107 and "Output via AtomX SDI Expansion Module" on page 110.

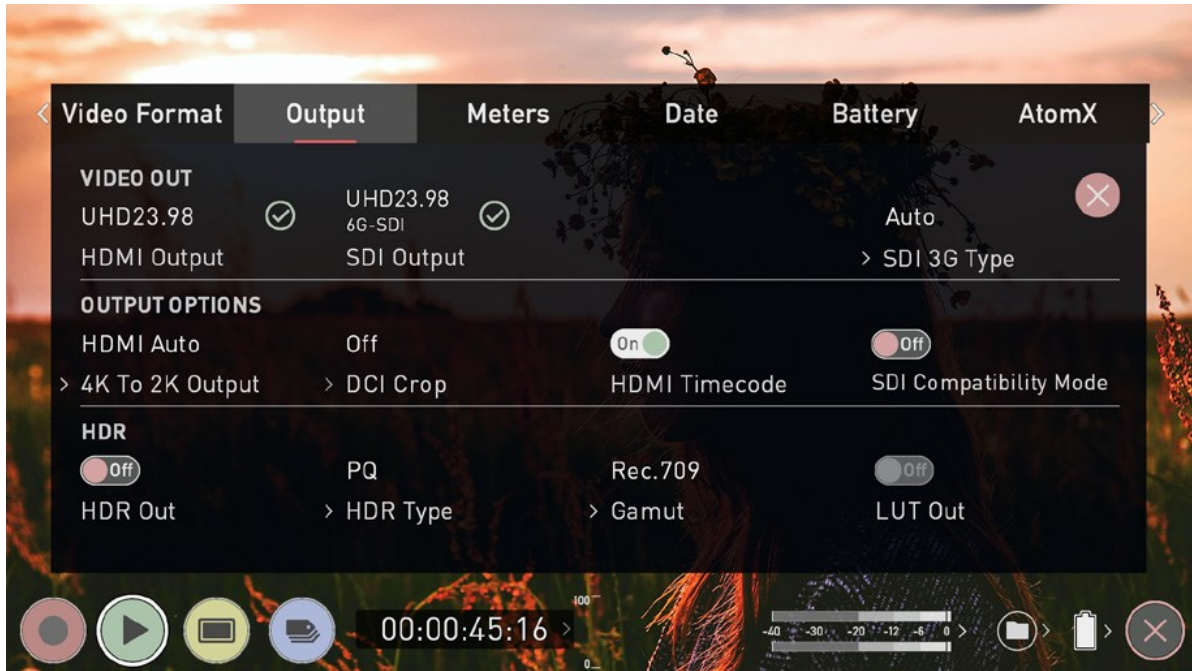

## Playback - Audio menu

The Audio menu that appears whilst in Playback mode is almost identical to the one that appears whilst in the Recording and Monitoring modes. For more information on these settings refer to "Audio Menu" on page 213 section.



*Some of the settings that are present in the Audio menu whilst in Recording and Monitoring modes, will not appear in the Audio menu whilst in Playback mode.*

## Edit Mode

The edit mode allows you to tag your clips during recording and playback, as well as the ability to add in and out-points to recorded clips.

By the pressing the Favorite and Reject icons you can assign a 'good clip' or 'bad clip'. This information can then be imported into a non-linear editing system to speed up the edit process. You can easily see which parts of your recording you have marked to keep or reject.

Favorite clips can easily be built into a Playlist in playback mode and these tagged sub clips can then be played out, back to back. For more information refer to the "Playlists" on page 341 section. ATOMOS 10 has also introduced extended tags to allow you to apply more specific tags that can help facilitate the edit. For more information refer to the "Using Extended Tags" on page 359 section.



*SmartLog is compatible with FCP XML (.fcpxml).*

## Playback Mode / Edit tools



## Main Controls

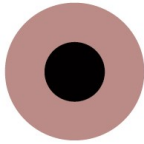

### **REC (Record):**

Press record to start recording



### **PLAY:**

Play and pause the current clip



### **MON (Monitor):**

Reveal/hide monitoring tools. Toggle on/off



### **EDIT:**

Reveal/hide edit tools. Toggle on/off



### **Settings**

There are no user accessible settings available for Edit functions in the current ATOMOS firmware.

This may change with future firmware updates.



In-point



Out-point



Favorite



Reject



Talent 1



Talent 2



Overexposed



Color



Noise

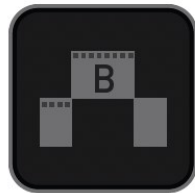

Cut Away



Close up



Wide Shot



Export



Reset



## Markers and Tagging Icons (SmartLog)

Using Markers and Tags you can quickly start the editing and review process right here on your NINJA V, avoiding delays incurred when importing inferior and unwanted footage. You can review and tag immediately on-set with your client or director, or work through your takes without having to dump the recorded files to another workstation/NLE.



### In-Point

Set the in-point by touching the button at desired point. Simply touch on to indicate in-point. Press a second time to reset in-point



### Out-Point

Out-point can be set by simply tapping at desired out-point. To remove, tap again



### Favorite

Mark the entire take as a favorite, or you can mark the parts of the take you wish to use. Apply multiple markers within one take if required



## Reject

Mark the take/section as a reject



## Talent 1

Tag talent or assign another meaning



## Talent 2

Tag talent number 2, or assign another meaning, event etc.



## Over Exposed

Tag clip as over exposed or out of focus



## Color Correction

Tag clip as 'color'. Use tag to indicate a problematic image or even use for another purpose



## Noise

Tag clip as containing background noise or interference



## Cut Away

Tag clip as a cut away scene



## Close Up

Tag clip as close up for use in edit and post



## Wide Shot

Tag clip as wide shot



## Export XML

Once your clips have been tagged you can capture all the information and utilize the XML data to speed up edit and post production time.



*SmartLog is compatible with FCP XML (.fcpxml).*



## RESET

Pressing the reset button will remove all tags and XML data from a clip. This is useful when dealing with multiple takes or if a clip is tagged incorrectly. Reset will not remove or change in-point and out-point settings. To remove markers you will need to reset the in and out-points.

# Using Edit tools during recording, playback and monitoring

To access edit tools simply tap the Edit icon during recording, monitoring or playback.

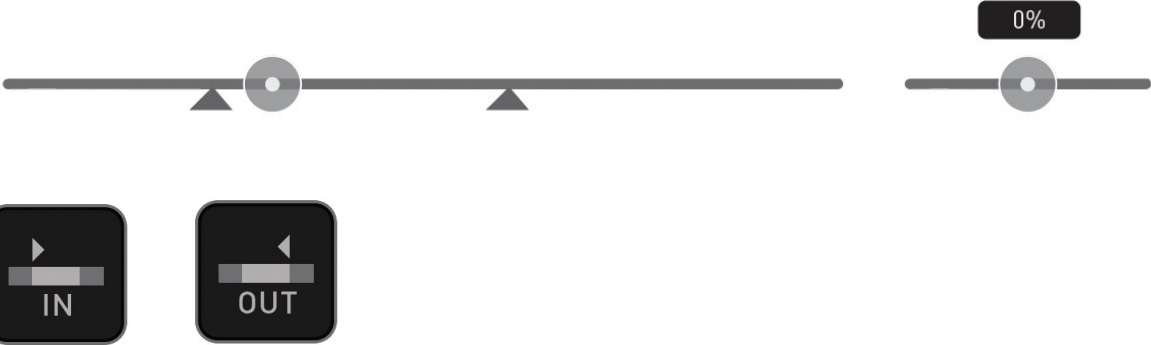

## In and Out points

Set in and out points easily during playback. Use the scrub control to accurately find the correct moment while the footage is paused. Once markers are set, the footage will be clipped and only the enclosed footage will play. Reset markers to resume normal playback.



## Favorite/Reject

Press Play and when you see the section of the footage you would like to mark as good or bad, press Favorite or Reject and then press again to stop marking that section. Multiple tags can be applied to your clips to provide Timecode accurate meta tags that can be exported to Apple FCP XML.



*A green or red line will appear in the timeline scrubbing bar so you can identify the region that has been selected.*



## **Reset**

Tapping the reset button will remove all tags and XML data from a clip. This is useful when dealing with multiple takes or if a clip is tagged incorrectly. Reset will not remove or affect in-point and out-point settings. To remove markers you will need to reset the in and out-points

## Using Extended Tags



Talent 1



Talent 2



Overexposed



Color



Noise

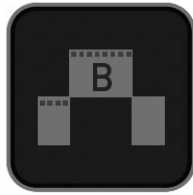

Cut Away



Close up



Wide Shot

Aside from Favorite and Reject tagging options, ATOMOS 10 includes extended tags that will greatly assist your edit and workflow processes. Careful consideration and use of tags during monitoring and review can be highly beneficial when you are ready to begin post production.

Tags are useful during playback and allow you to create playlists featuring only selected recordings from your disk. More information about playlists can be found in the Playback & Playout section.



### Reset

Tapping the reset button will remove all tags and XML data from a clip. This is useful when dealing with multiple takes or if a clip is tagged incorrectly. Reset will not remove or affect in-point and out-point settings. To remove markers you will need to reset the in and out-points



# Exporting Tags



## Exporting Tags

1. Tap the Export icon to export the tags you have created to an FCP XML file.
2. 'Please wait' will be displayed on screen whilst an XML file is being created on your inserted media. The length of time required to create the FCP XML file will vary depending on your recording time and the amount of flags applied.
3. Once the XML file has been saved to your media you will be returned to the previous screen.

## Importing Tags

The FCP XML file can be instantly accessed by Final Cut Pro when the media is connected to a computer using a compatible dock. The tags will be available upon import of the XML file and can be used to filter and display different parts of your recordings, depending on how you have used the tags to mark and edit the footage. More information about using tags and XML import can be found in the Connecting & Editing section.



*SmartLog is compatible with FCP XML (.fcpxml).*

## Connecting media

The Master Caddy Docking Station allows you to connect your media to your computer. For information on using the Master Caddy Docking Station and the different models available, refer to the "Master Caddy Docking Station" on page 35 section.

### Attaching Media to a Master Caddy Docking Station:

1. Eject the media from your NINJA V.
2. Align your AtomX SSDmini, Master Caddy II or AtomX CFast adapter so that the SATA III connector lines up with the SATA II connector on the Docking Station. Media can't be inserted the wrong way round.
3. Gently slide your media all the way into the Docking Station until it stops at the end of the drive slot. Ensure that the media is properly attached.



*Never force the media into the docking station, just in case something isn't set up or aligned properly*



*The NINJA V disk slot does NOT have a release latch for media. It is a friction-fit system. To remove simply pull the media out using the top and bottom tabs on the media itself.*

## **Connecting the Master Caddy Docking Station to your computer:**

1. Connect the Master Caddy Docking Station to a Mac® or Windows® editing workstation via USB 2.0, USB 3.0 or USB-C 3.1.
2. After a short wait, your disk will be recognized by your operating system and the recorded video will be accessible by the target computer via a standard disk (exFAT) file system.

Once your disk is recognized by your operating system, you can edit directly from the drive or copy the files to your own storage.

## **Transferring files**

To copy files to your computer or other storage location:

### **Windows:**

Open the disk in My Computer > Select all the files or just the ones you wish to transfer, copy and paste them to your desired location. (ctrl+c to copy, ctrl+v to paste).

### **Mac OS:**

Your NINJA V disk will show in Finder. Select the files you wish to transfer, drag the files to your desired location or use the copy and paste commands. (COMMAND + C to copy, COMMAND + V to paste).

## **ExFAT compatibility**

The NINJA V formats your media as exFAT. We have chosen this file system to overcome the 4GB file limitation of FAT32 and allow for compatibility on both Windows and MAC OS.

The Operating Systems that support exFAT are:

- Windows 10+
- Snow Leopard 10.6.5 or higher
- Lion 10.7

- Mountain Lion 10.8
- Mavericks 10.9 and above

# Importing clips

## Video Codecs - Supported Applications

We have chosen the Apple ProRes®, Avid DNxHD® and Avid DNxHR+ codecs as our main video codecs since they are visually lossless, as well as being edit-ready formats. The H.265 (HEVC) codec is also available as an optional upgrade, and provides a highly efficient compressed codec option. For more information refer to the "H.265 (HEVC)" on page 122 section.

Generally speaking, all major non linear editing applications support Apple ProRes and Avid DNxHD/DNxHR, and most have support H.265 (HEVC). Applications need to support these codecs inside a .MOV wrapper.

Please refer to the support documentation for your software for compatibility, especially with 10 Bit 4:2:2 H.265.

- Final Cut Pro (version 7)
- Final Cut Pro
- Davinci Resolve 8.0 +
- Adobe CS5 (with 5.51 update or later)
- EDIUS 6
- Sony Vegas 10
- Lightworks
- Avid Media Composer 6 (version 8.3 or later for DNxHR)
- Autodesk Smoke

## ProRes RAW - Supported Applications

- Apple Final Cut Pro
- Adobe Premiere Pro,
- Adobe After Effects,
- Avid Media Composer,
- GrassValley Edius,
- Assimilate Scratch,
- Baselight Film Light.

## Importing NINJA V footage into Final Cut Pro

You can import NINJA V footage into Final Cut Pro (FCP) in just a few simple steps.

1. Connect the Docking Station to your Mac. For information on connecting the Docking Station refer to the "Connecting media" on page 361 section.
2. Insert the media with your footage into the Docking Station and you will see the drive appear in your Finder window.
3. Start Final Cut Pro and open your project (or start a new one).

The screen will look like this:

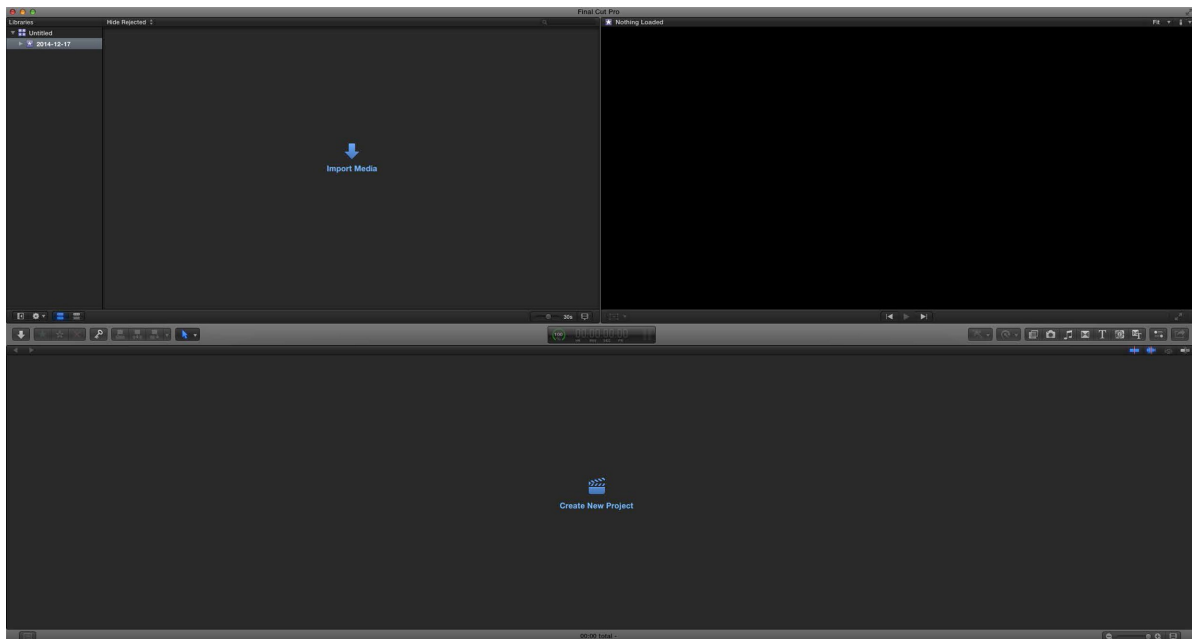

Go to the File menu and select Import > Media. Final Cut Pro will show you a 'browse' window. Look for the NINJA V drive, and click on it.

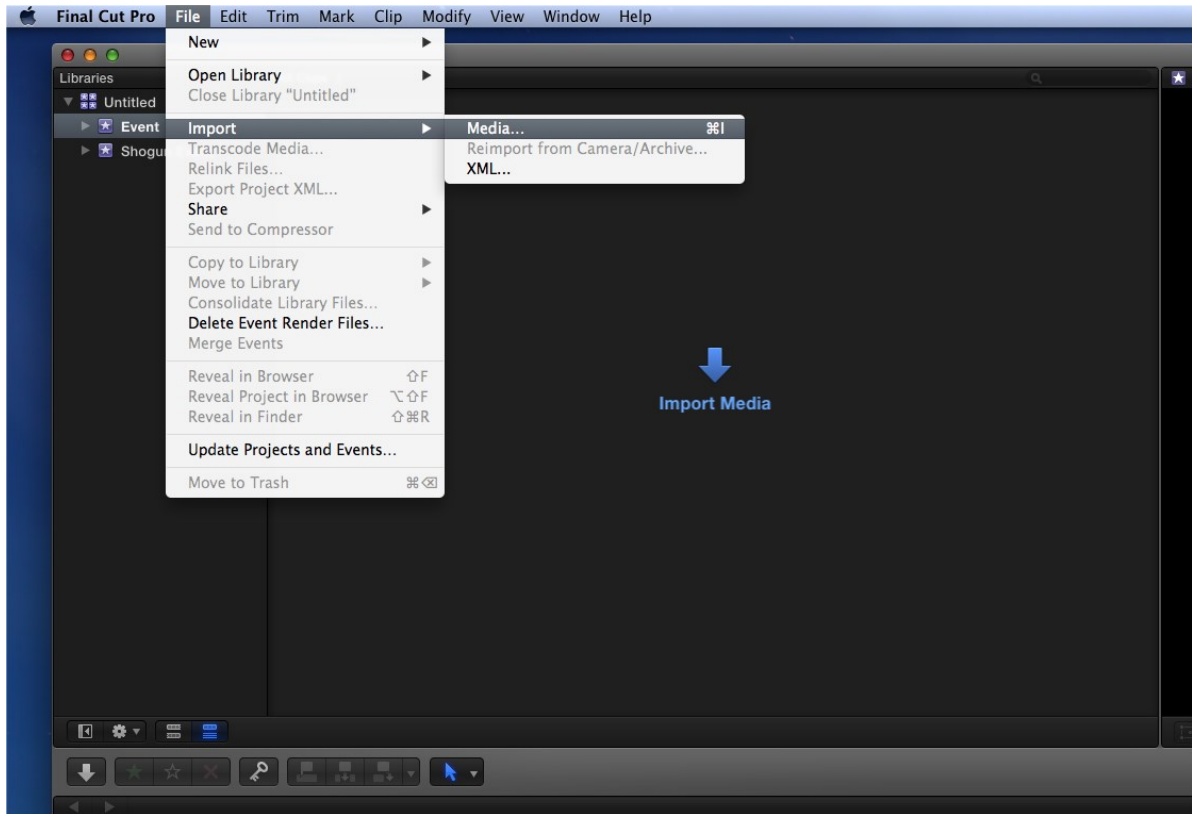

You'll see the folders in the drive. Select the folder containing the footage you want to import. Click on Import All or Import Selected. Individual clips can also be selected.

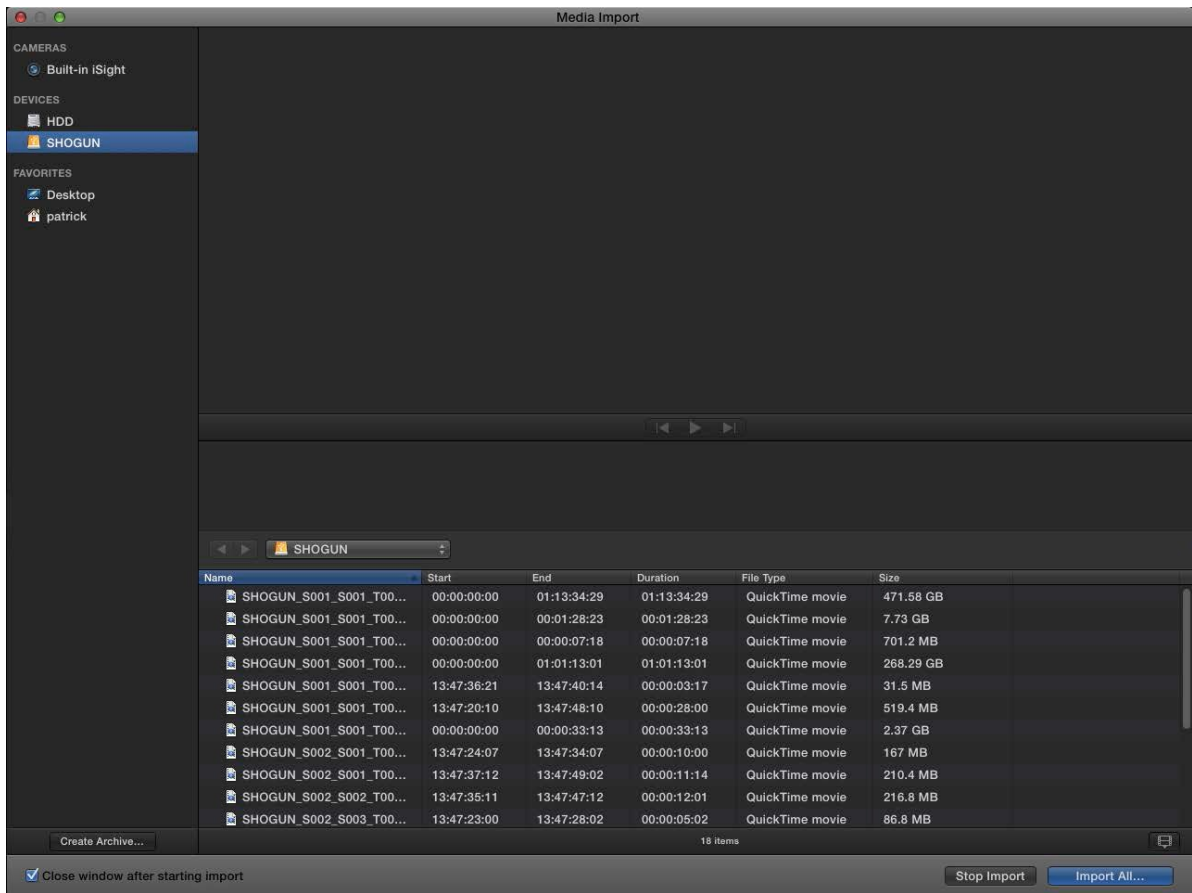

Choose the Event you wish to import the footage into, or create a new event. Click on Import.



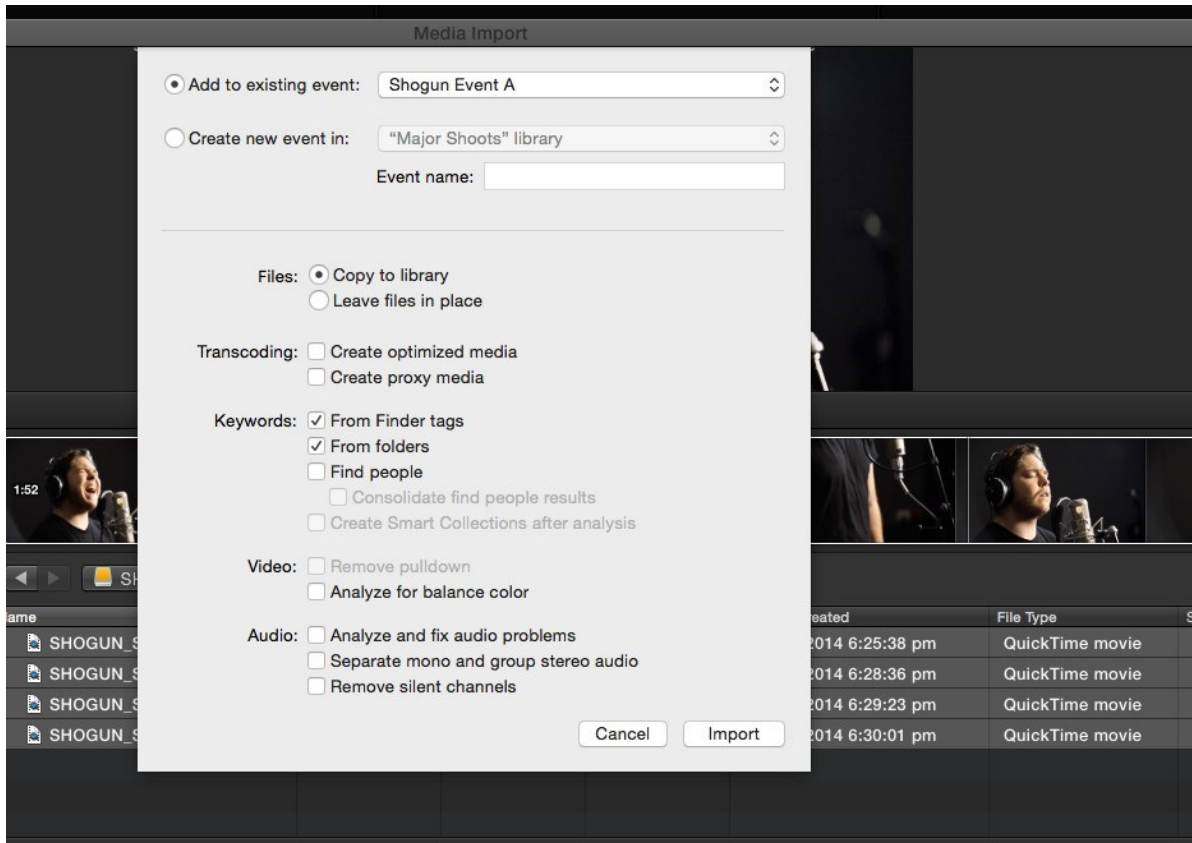

Your Scene, Shot and Take files now appear in the project window, ready for use in your FCP project.



# SmartLog with Final Cut Pro

## Prior to importing the XML files into Final Cut Pro, ensure that:

- You have exported XML file whilst the drive is in your NINJA V
- You have connected your Master Caddy Docking Station and inserted your media into the Dock
- You are using an operating system that supports ExFAT
- Your QuickTime version is up to date
- Final Cut Pro has been updated to the latest version

## There are 2 ways to import the XML file:

- Directly from the docked hard drive
- Manually into Final Cut Pro

### Automatic Import

1. Open the Finder
2. Select the drive (in this example it is EXCVIDEO)
3. Double-click the unitname.FCPXML file
4. This will open Final Cut Pro and import the .xml file
5. Final Cut Pro will make an event of the disk, name and reference all the footage in that event.

You will notice that on the clips you have added Smart Tags too, with Green and Red indicating Favorite and Reject. You can sort these by using the pull-down menu to show favorites. This will show all the individual favorites as separate clips in the Event Viewer.

### Manual

1. Open Final Cut Pro
2. Create a New Project (or you can use an existing project). In this example it is called XML Import
3. Select File> Import> XML

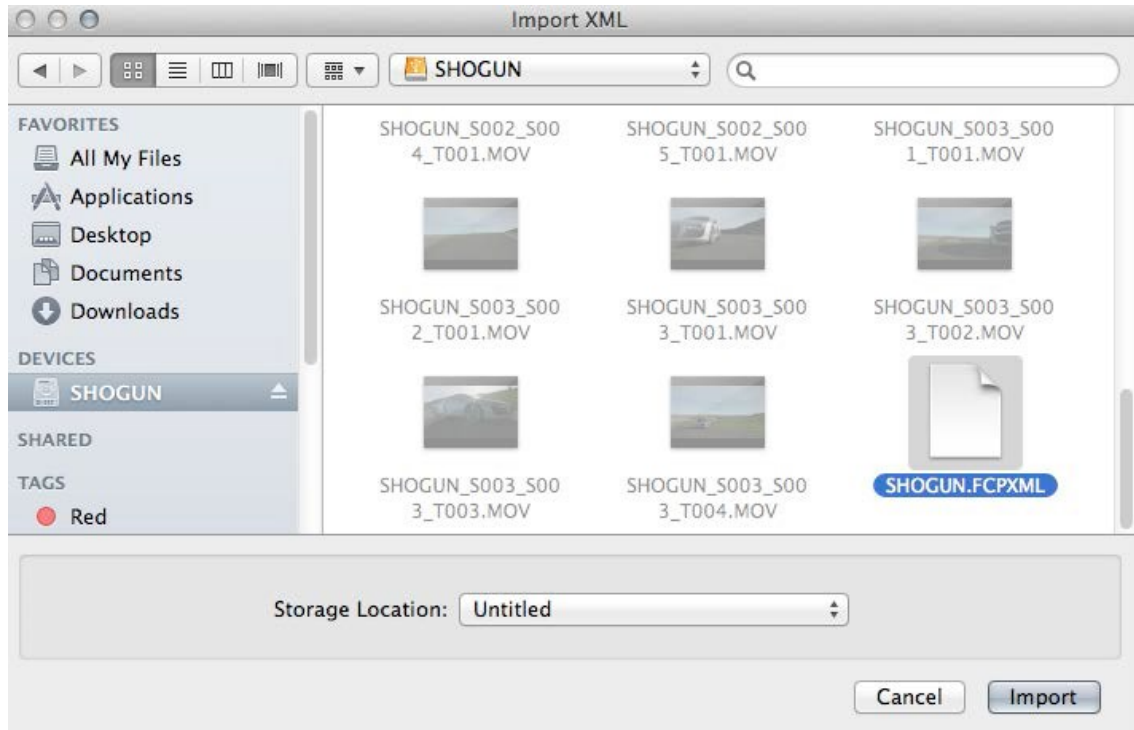

4. Select the NINJA V drive under Devices
5. Choose the unitname.FCPXML, select Import
6. The XML will import

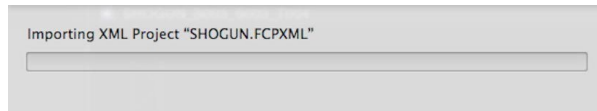

## Viewing tags in Final Cut Pro

Once you have imported the XML you can expand the clip to see the Favorite, Reject and other various tags.



You can also filter the view to only see specific tags e.g.. favorite, etc.

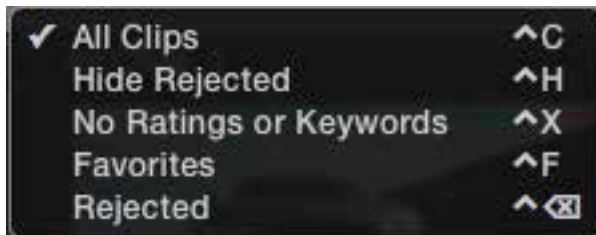

# Adjusting ProRes RAW settings in Final Cut Pro

Final Cut Pro allows you to view and adjust the camera settings of ProRes RAW files, like ISO, exposure offset and color temperature in the Inspector tab. The settings that can be adjusted will depend on the camera used with your NINJA V to record ProRes RAW clips. For information on the cameras that record ProRes RAW and the settings that can be adjusted, refer to the 'ProRes RAW video cameras and devices' section in the [Apple Support Article](#).

## How to adjust ProRes RAW camera settings in Final Cut Pro

1. Import your Apple ProRes RAW clips into Final Cut Pro. For more information on importing refer to the "Importing clips" on page 364 section.
2. Select the clip(s) that you want to adjust in the browser or in the timeline.

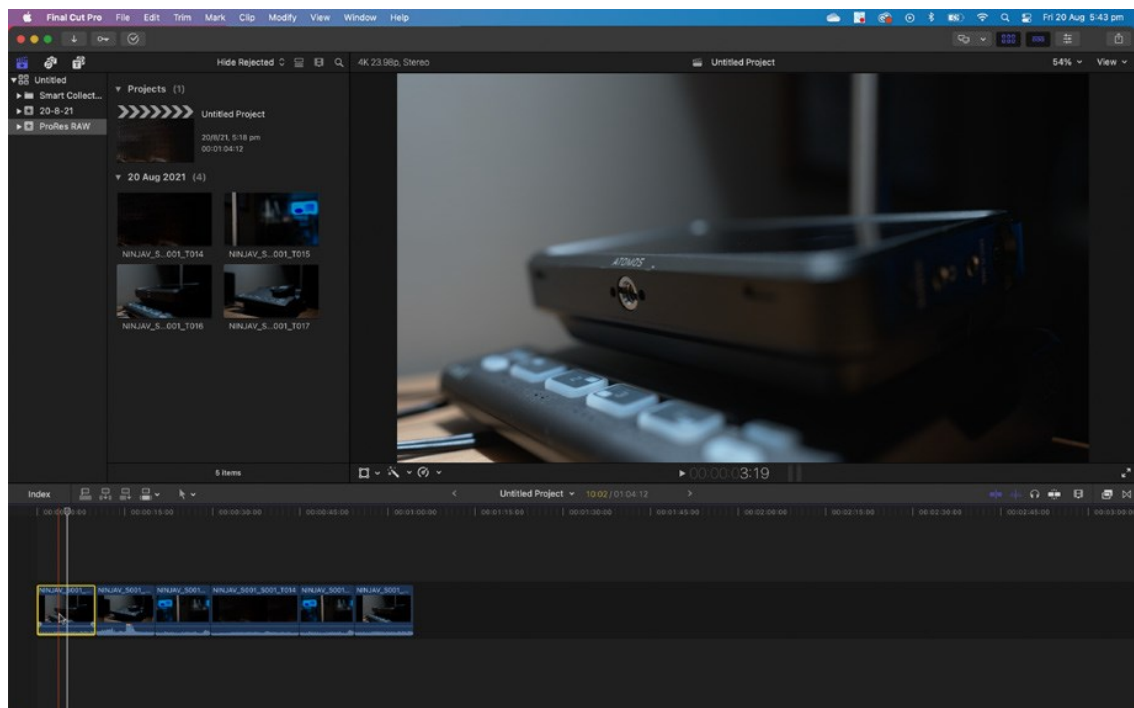

3. Open the Inspector by clicking on Window>Show in Workspace>Inspector

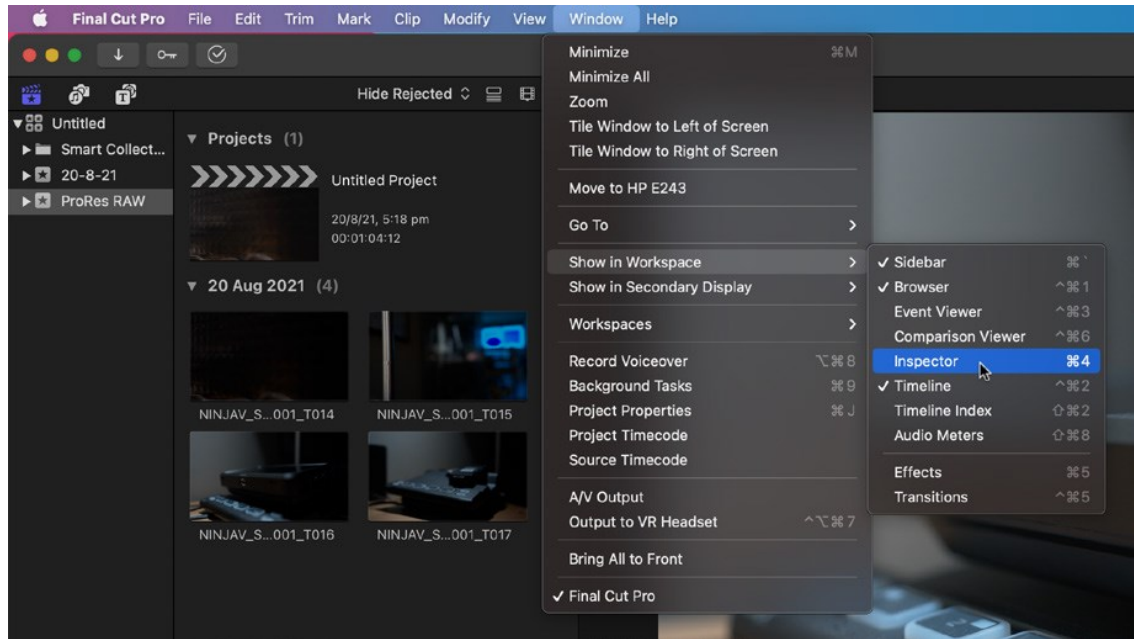

4. Click on the Info button in the Inspector to show the Info Inspector

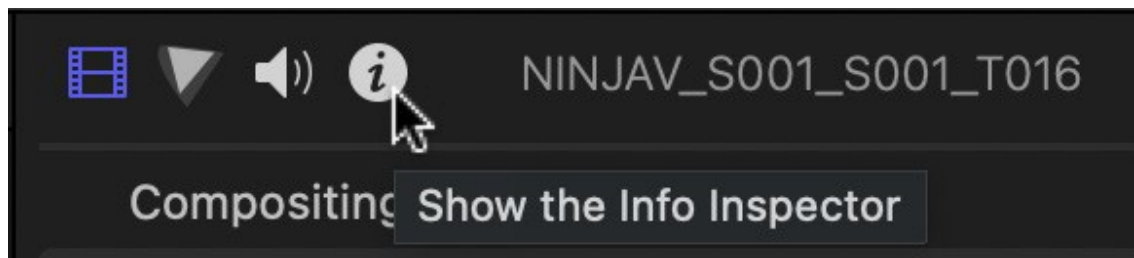

5. Click on the word Basic at the bottom of the Info Inspector tab to open the Metadata View pop-up menu, and select Settings.

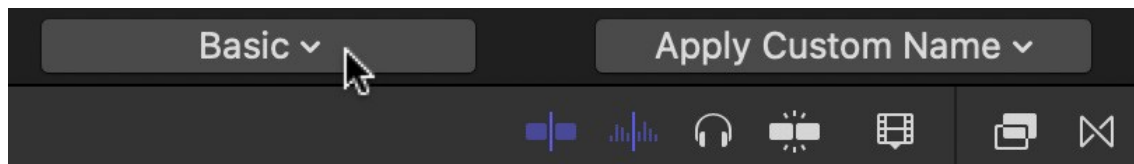

6. The Info Inspector will now display the camera settings of the ProRes RAW clip(s).

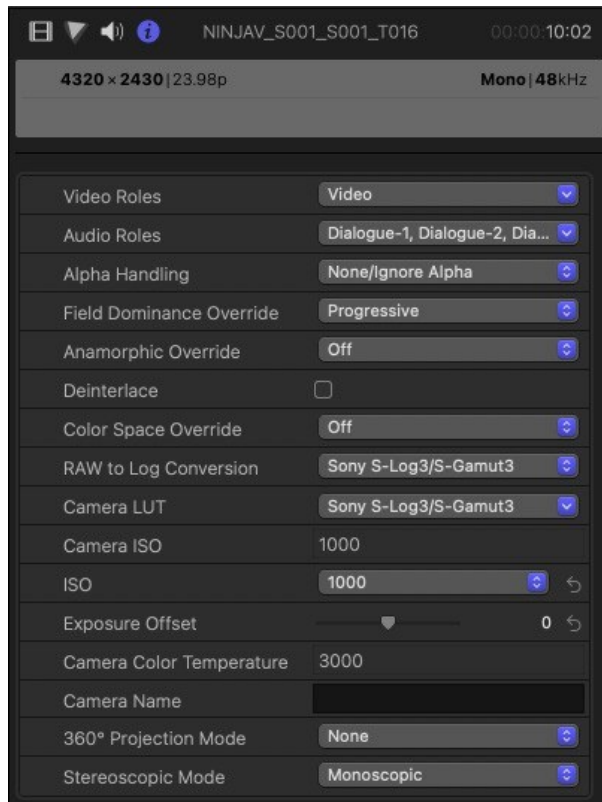

### Camera ISO

Displays the ISO setting selected in camera during the recording of the selected ProRes RAW clip(s). This is for information purposes only and is not adjustable.

### ISO

This drop-down menu allows you to adjust the ISO setting for the selected clip(s).



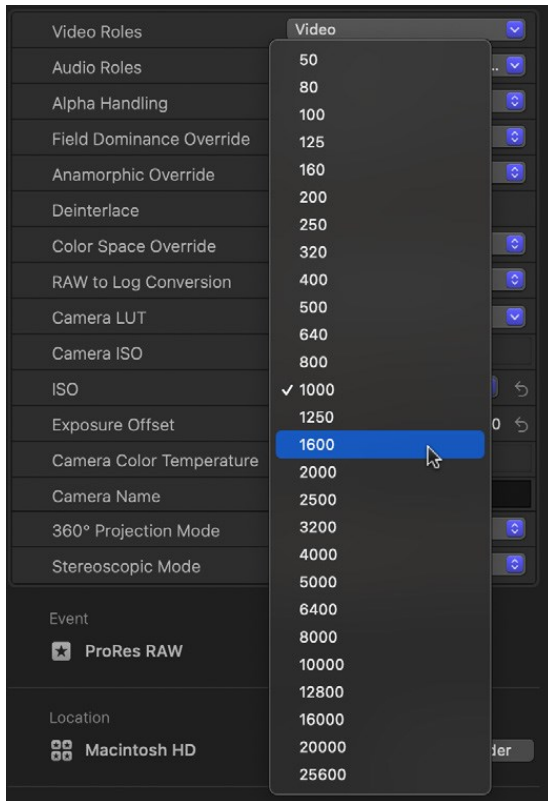

## Exposure Offset

Adjusts the ISO setting up or down by as much as one stop.

## Camera Color Temperature:

Displays the color temperature setting selected in camera during the recording of the selected ProRes RAW clip(s). This is for information purposes only and is not adjustable.

## Temperature

Adjusts the color temperature setting for the selected clip(s). This slider only appears where the camera used to record the ProRes RAW clip(s) supports color temperature adjustments.

For more information on the cameras supported and the settings that can be adjusted, refer to the ['Adjust ProRes RAW camera settings in Final Cut Pro'](#) Apple Support Article.

## Technical Specifications

<b>Physical Specifications</b>	
Without batteries & media	360g / 12.7oz
Dimensions (W x H x D mm)	151 x 91.5 x 31mm
Mounting points	Anti-rotational 3/8-16 screw mount points with 1/4-20 screw mount adapter. Top and bottom.
<b>Environmental</b>	
Ambient operating temperature	Up to 40° C
<b>Construction and Control</b>	
Body	Aluminium alloy chassis with ABS Polycarbonate back plate
Cooling	Heat Sink and actively controlled fan with user selectable modes in menu
Tally light	Rear and front (Red border on the display indicates record)
Multi-function button	Power / lock Screen
AtomXpansion slot	Yes
<b>Power</b>	
Touchscreen	SuperAtom IPS panel (capacitive touch)
Operating power	10 - 22W
Compatible batteries	NPF /L series and supporting accessories
Input voltage	5.8 - 7.2V (Battery)
Battery time (based on 7.4V)	5200mAh - up to 2hrs (monitor & record 4Kp60), 7800mAh - up to 3hrs (monitor & record 4Kp60)

DC In Connector	Via DC Jack on Battery Eliminator
Continuous power	Via Optional AtomX SYNC Module
D-Tap	Via Battery Eliminator and optional D-Tap to DC cable
<b>Display</b>	
Touchscreen	SuperAtom IPS panel (capacitive touch)
Size	5.2"
Resolution / PPI	1920 x 1080px
PPI	423
Bit Depth	10-bit (8+2 FRC)
Backlight Type	Edge lit
Brightness (cd/m <sup>2</sup> / nits)	1000 +/- 10%
Aspect ratio	16:9 native
De-interlace mode	I > P and PSF > P
Color Gamut	Rec. 709
Calibration support	ATOMOS Calibrator with Calibrite i1 Display Pro / Plus (Retail)
<b>Color Pipeline</b>	
AtomHDR	Yes
Gamma	Sony SLog / SLog2 / SLog3, Canon CLog / CLog2 / Clog3, ARRI Log CEI160 / LogCEI200 / LogCEI250 / LogCEI320 / LogCEI400 / LogCEI500 / LogCEI640 / LogCEI800 / LogCEI1000 / LogCEI1280 / LogCEI1600, Nikon N-Log, Panasonic V-Log, JVC J-Log1, Olympus (OM System) OM-Log400 / Flat, Licia L-Log, Z Cam Z-Log2, RED LogFilm / RED Log3G10 / RED Log3G12, FujiFilm F-log, PQ (HDR10), HLG
Gamut	Sony SGamut / SGamut3 / SGamut3.cine, Canon Cinema, DCI P3 / DCI P3+ / DCI-P3 D65, Rec709, BT.2020, Nikon NLog, Panasonic V-Gamut, Arri Alexa Wide Gamut, FujiFilm F-Gamut, JVC LS300, RED WideGamut / RED DragonColor / DragonColor2 / RED Color2 / RED Color3 / RED Color4

3D LUT Display	.Cube Format
3D LUT Down Stream	Loop out
3DLUT 50/50	Yes
Monitoring Modes	Native / Rec.709 / HLG / PQ / 3D LUT
HDR output Conversion	Log / HDR to HLG / PQ / Dolby Vision
<b>Video Input</b>	
HDMI	1 x HDMI (2.0) 4Kp60
HDMI RAW	Apples ProRes RAW up to 6K
SDI	2 x 12G SDI Backward compatible via optional AtomX SDI module, or 1 x 12G SDI via optional ATOMOS CONNECT
SDI RAW	Optional with ATOMOS CONNECT or AtomX SDI module and SDI RAW activation
Bit Depth	8/10-bit Video / RAW up to 12-bit
Video Chroma Subsampling	4:2:2
HDCP copy protection	Not supported
<b>Metadata</b>	
HDMI	RAW - white balance, exposure index, shutter speed/angle, iris F stop, ISO, gamma, gamut
SDI	File name from Arri, RED via optional AtomX SDI module or optional ATOMOS CONNECT
<b>Video Output (Playout)</b>	
HDMI	1 x HDMI (2.0) 4Kp60
SDI Loop Out	Optional Via AtomX SDI module
SDI Play Out	2 x 12G SDI via optional AtomX SDI module - level A/B selectable
Video Chroma	4:2:2

Subsampling	
Signal	Uncompressed true 10-bit or 8-bit 422 (playback file dependent)
<b>Web Streaming</b>	
USB UVC	Optional via Connect 4K or AtomX CAST
RTMP	Yes via optional Atomos CONNECT
RTMP/S	Yes via optional Atomos CONNECT
<b>Video Signal Conversion</b>	
HDMI to SDI	Optional Via AtomX SDI module
SDI to HDMI	Optional via ATOMOS CONNECT or AtomX SDI module
<b>Audio In/Out</b>	
Audio Quality	24-Bit / 48kHz
Audio Codec	PCM
HDMI	8ch 24-bit, input dependent
SDI	12ch 24-bit, input dependent
Analog Audio in	3.5 mm 2ch.
Headphone out	3.5 mm 2ch.
<b>Timecode / Sync</b>	
Embedded	HDMI and SDI (ATOMOS CONNECT or AtomX SDI module required for SDI embedded timecode)
Time of day	Yes, Time and Date
LTC	Via 3.5 mm audio Jack input (requires post processing)
Wireless SYNC	AirGlu™ SYNC Time code Network Server or Client via optional AtomX SYNC or Atomos CONNECT
RF Network range	300m
RF Frequency	Region dependent
Number of Channels	12 RF Channels per Region

Number of RF clients	Region dependent
<b>Network</b>	
Ethernet	1GbE RJ45 via optional ATOMOS CONNECT
Wi-Fi	Wi-Fi 6 via optional ATOMOS CONNECT
Wireless RF	AirGlu™ SYNC Time code Network via optional ATOMOS CONNECT or AtomX SYNC module
Cellular	Connect to Hot Spot over Wi-Fi via optional ATOMOS CONNECT
<b>Resolution and Frame Rates (Record, Monitor &amp; Playback)</b>	
6K	RAW Only up to 30p via HDMI
5K	RAW Only up to 30p via HDMI
4K DCI	23.98 /24 /25 /29.9 /30 /50 /59.94 /60p
4K UHD	23.98 /24 /25/ 29.9/ 30/ 50/ 59.94/ 60p
2K DCI 2046 x 1080	23.98 /24 /25/ 29.9/ 30/ 50/ 59.94/ 60p/
Anamorphic	3.5K: RAW up to 60p (from supported cameras only)
FHD 1920 x 1080 Progressive	23.98 /24 /25 /29.9 /30 /50 /59.94 /60 /100 /120p
FHD 1920 x 1080 PsF	Converted to P and looped out PsF
FHD 1920 x 1080 Interlaced	23.98 /24 /25 /29.9 /30 /50 /59.94 /60i
1280 x 720p	50 /59.94 /60p
<b>Recording Codec</b>	
Apple ProRes RAW	ProRes Raw, ProRes RAW HQ (activation required)
Apple ProRes	LT, 422, 422HQ
Avid DNxHD	220x, 220, 145, 36 (activation required)
Avid DNxHR	LB, SQ, HQ, HQX (activation required)

H.265	LQ, MQ, HQ in 8/10Bit, 4 2 2 and 4 2 0 (activation required)
<b>Playback</b>	
Playlist	Yes, Create custom play lists from full or sub clips
Loop	Yes, with user customizable in / out markers
Apple ProRes RAW	Yes, recorded clips with linear PCM audio
Apple ProRes	Yes, with Linear PCM audio
Avid DNx	Yes, with Linear PCM audio
H.265 (HEVC)	Yes, recorded clips with linear PCM audio
<b>Recording functions</b>	
Pre-roll record	Yes (HD 8s, 4K 2s) - Not available in RAW
Timelapse	Yes
<b>Multi Input / Switching</b>	
SDI A/B toggle	Via optional AtomX SDI module
Switching	Via optional AtomX CAST module
<b>Supported media</b>	
Master Caddy I	Not Compatible
Master Caddy II	For 2.5" Drives in MasterCaddy II
Master Caddy III	For 2.5" Drives in MasterCaddy III (Required when using Atomos CONNECT)
SSDmini	Native size and fit
CFast II	Supported cards via optional AtomX CFast Adapter
<b>File Naming</b>	
File Naming	Unit name - Scene, Shot, Take. File name via optional AtomX SDI adapter or optional ATOMOS CONNECT for Arri and RED
File System	ExFAT
<b>On Screen Tools</b>	
Waveform	Yes, 3 size / position

RGB parade	Yes, 3 size / position
Vector scope	Yes, 2 size / position
1 x Zoom	Yes. 1:1 Pixel mapping for 4K
2 x Zoom	Yes
Focus peaking	Color selected / threshold setting / color / mono / edges only
False color	Yes, with false color scale
Zebra	Yes, adjustable
Isolate color channel	Blue Only
Cine Frame Guides	16:9, 2.4:1, 2.35:1, 1.9:1, 1.91:1, 1.85:1, 4:3
Social Frame guides	9:16, 1:1, 1.91:1, 4:5
Safe areas	Action and Graphic
Grid markers	9 grid
Anamorphic desqueeze	1.25x 1.33x , 1.5x ,1.8x ,2x, 2x 4:3
Display Flip	180 degree rotation
<b>Onboard Signal Processing Options</b>	
Pulldown Removal	24/25/30pSF > 24/25/30p (2:2 pulldown) 60i > 24p (3:2 pulldown)
4K UHD Down-scale for HD	Loop out - 4K UHD to FHD
DCI Crop	Loop out - 17:9 to 16:9 Crop
<b>Remote control</b>	
HDMI	Auto HDMI Trigger, Supported Protocols - Canon, Sony, ATOMOS Open Standard
SDI	SDI trigger camera selectable
Serial 2.5mm Jack	LANC control and calibration via optional USB to serial cable



Bluetooth LE	Via AtomRemote app (requires optional ATOMOS CONNECT or AtomX SYNC module)
Wireless RF	Via optional ATOMOS CONNECT or AtomX SYNC module
<b>External Device Control</b>	
Serial 2.5mm Jack	Camera control for supported cameras via Optional USB to Serial Cable
Bluetooth LE	Via optional ATOMOS CONNECT or AtomX SYNC module to compatible devices
Wireless RF	Via optional ATOMOS CONNECT or AtomX SYNC module to compatible devices
<b>Supported Applications</b>	
XML	Cut tag EDL in Final Cut Pro XML
Apple ProRes RAW	Apple Final Cut Pro, Adobe Premiere, After Effects, Avid Media Composer, GrassValley Edius, Assimilate Scratch, Baselight Film Light.
Video Codecs	All NLE applications that support Apple ProRes, Avid DNx and H.265 in .MOV wrapper
<b>What's in the box</b>	
Accessories included	NINJA V, 1 x Battery eliminator, 1 x international DC power supply, 1 x MasterCaddy II and QuickStart Guide
Optional extras	5" Accessory kit, Sunhood, DC to D-Tap, Power Kit, HDMI cables, USB to serial cable, Master Caddy Docking Station, ATOMOS CONNECT, AtomX SYNC module, AtomX SDI module, AtomX CAST module, UltraSync ONE, UltraSync Blue
<b>Warranty</b>	
Standard	1 year. Extended to 3 years on product registration

Construction note: Your NINJA V is designed to operate in ambient temperatures up to 40°C/104°F. If you wish to extend the temperature of operation in high temperature conditions, you can use the cooling options. For more information, refer to the "Power Menu" on page 221 section.

Please note: Specifications are subject to change without notice. All information assumed correct at time of publishing.

© ATOMOS 2022. TM ®All trademarks and registered trademarks are the property of their respective owners.