

VIDEO DEVICES



PIX-E5 / PIX-E5H

Recording Field Monitor

User Guide

Legal Notices

Product specifications and features are subject to change without prior notification.

**Copyright © 2015
Sound Devices, LLC.
All rights reserved.**

This product is subject to the terms and conditions of a software license agreement provided with the product, and may be used in accordance with the license agreement.

This document is protected under copyright law. An authorized licensee of this product may reproduce this publication for the licensee's own personal use. This document may not be reproduced or distributed, in whole or in part, for commercial purposes, such as selling copies or providing educational services or support.

This document is supplied as a technical guide. Special care has been taken in preparing the information for publication; however, since product specifications are subject to change, this document might contain omissions and technical or typographical inaccuracies. Sound Devices, LLC does not accept responsibility for any losses due to the user of this guide.

Trademarks

The "wave" logo and USBPre are registered trademarks, and FileSafe, PowerSafe, Wave Agent, and PIX-Assist are trademarks of Sound Devices, LLC.

Mac and OS X are trademarks of Apple Inc., registered in the U.S. and other countries. Windows is a registered trademark of Microsoft Corporation in the United States and other countries. Gorilla is a registered trademark of Corning Incorporated.

Manual Conventions

Symbol	Description
>	This symbol is used to show the order in which you select menu commands and sub-options, such as: System > Version Info indicates you use the Control knob to navigate the Main menu and select System followed by Version Info.
+	A plus sign is used to show button or keystroke combinations. For instance, ALT+MENU means to hold the ALT button down as you press the MENU button. Ctrl+V means to hold the Control key down and press the V key simultaneously.
ⓘ	A note provides recommendations and important related information. The text for notes also appear italicized in a different color.
⚠	A cautionary warning about a specific action that could cause harm to you, the device, or cause you to lose data. Follow the guidelines in this document or on the unit itself when handling electrical equipment. The text for cautionary notes also appear bold and italicized in a different color.

PIX-E5 User Guide • Rev 1-B • August 7, 2015

This document is distributed by Sound Devices, LLC
in PDF format only. E-published in the USA.

www.sounddevices.com

support@sounddevices.com

Sound Devices, LLC
E7556 Road 23 and 33
Reedsburg, Wisconsin USA

+1 (608) 524-0625
Toll Free: (800) 505-0625
Fax: +1 (608) 524-0655

Revision History

This table provides the revision history of this guide.

Rev#	Date	Firmware Version	Description
1-A	July 2015	v1.00	Initial Official Publication
1-B	Aug 2015	v1.01/v1.02	Updates that addressed the 4K speckling and added one feature: "file deletion"

Table of Contents

Overview of the Chassis 7

Top and Front Panels	7	Back and Bottom Panels	9
Left Side Panel	9	Right Side Panel	11

Menus and Navigation 13

Touch Screen and Tactile Controls	13	Record Soft Keys	16
Accessing the MAIN MENU Screen	13	Using Soft Key Menus	17
Toggling On-Screen Display Elements	14	Configuring the On-Screen Display	18
Toggling Soft Key Button Functionality	15	USB Keyboard	19
Monitor Soft Keys	16		

PIX-Assist Monitoring Suite 21

Overview	21	Using the Waveform Monitor	29
Assist Tools	22	Using the Vectorscope	31
Using False Colors	22	Using the Histogram	32
Using Zebras	24	Using 4-Way Monitoring	33
Using Zoom	25	Using Markers	34
Using Peaking	27	Resetting Monitor Defaults	37
Scopes	29		

Storage 39

SpeedDrive	39	Formatting Storage Drives	42
SD Memory Card	40	Working with Files	42
Metadata and File Name Format	40	Deleting Recorded Files	43
File Name Formats	41	Transferring Files to a Computer	43

Recording and Playback 45

Record and Playback Icons	45	Setting PsF Options	47
Recording	45	FileSafe	48
Choosing a Video Input Source	46	Viewing the File List	48
Setting up a Record Trigger	46	Playing Back Recorded Files	49
Selecting a Video Codec	47		

Audio 51

Using the Audio Screen	51	Configuring Audio Output	54
Setting up Audio Input	52	Adjusting Headphone Warning Bell Level	55
Setting up Tracks	53		

Timecode 57

Setting a Timecode Mode	57	Setting the Rec Run Timecode Value	58
Toggling Drop Frame Timecode	58		

System Functions 59

Time and Date	59	Saving and Recalling Settings	61
Setting the Date and Time	60	Restoring Factory Default Settings	62
Updating Firmware	60		
Checking Version and Serial Number	61		

Specifications

63

PIX-E5 Specifications.....	63	Audio	66
Video	63	Storage.....	67
Audio	64	Timecode	67
Storage.....	64	Power	67
Timecode	65	Physical.....	67
Power	65	Environmental	67
Physical.....	65		
Environmental.....	65		
PIX-E5H Specifications	66		
Video	66		



Overview of the Chassis

The PIX-E5 and PIX-E5H are specifically designed and built for the rigors of field production.

The chassis is made of high-strength, thermally conductive aluminum. As well as providing maximum durability, the case doubles as a heat-sink, providing excellent cooling of the inner electronics.

By design, the PIX-E chassis gets very warm, wicking away the heat from the internal components. This design ensures that the internal components stay cool for years of trouble-free operation in the most demanding environments.

Topics in this section include:

- ▶ **Top and Front Panels**
- ▶ **Left Side Panel**
- ▶ **Back and Bottom Panels**
- ▶ **Right Side Panel**

Top and Front Panels

The top panel features the Power switch, a Power LED, a 1/4-inch, 20-threaded mounting point, and two retainer clips used to secure batteries and the Speed-Drive to the back of the monitor.

The front panel has a sunlight-readable, 5-inch LCD that is protected behind an alkali-aluminosilicate sheet of Gorilla® Glass 2, chemically strengthened to be scratch- and impact-resistant.

Beneath the LCD is a row of buttons, which includes an ALT button on the left, a MENU button on the right, and in between them, 11 multi-functional soft key buttons.

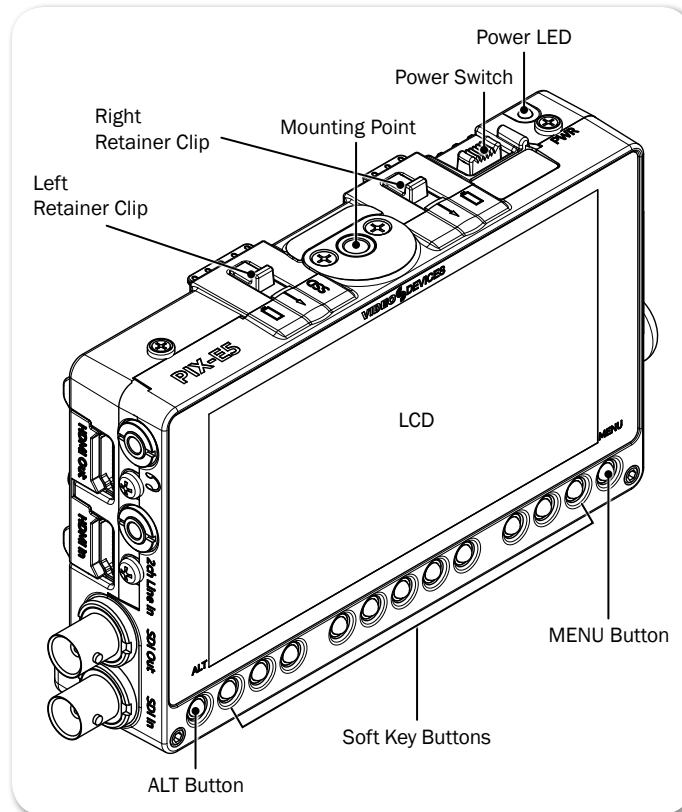

FEATURE	DESCRIPTION
Power Switch & LED	Slide the Power switch to the right to turn on the device. While power is on, the LED will illuminate green. When power is first turned on, a splash screen with the Video Devices logo will appear on the LCD.
<p>① <i>PIX-E monitors have a very powerful processor and operating system, so it takes up to 45 seconds to boot the first time. However, the QuickBoot™ feature reduces subsequent boot times throughout the rest of the day to just a few seconds. To use QuickBoot, keep a power source connected and use the Power switch to turn monitor on and off.</i></p>	
Retainer Clips	<p>The retainer clips snap into place to securely hold batteries and/or the SpeedDrive™ to the back of the monitor. The right clip, labeled with a battery icon, secures the right L-mount battery; the left clip, labeled SSD, holds both the SpeedDrive and the left L-mount battery.</p> <p>Depress the spring-loaded retainer clips toward the front of the monitor to release the drive and batteries.</p>
Mounting Point	Centered on the top and bottom panels, a 1/4-inch, 20 threaded, stainless-steel mounting point may be used to attach the monitor to a camera or other production gear, such as the PIX-ARM.
LCD	5-inch LCD touch screen. 1920x1080 pixel resolution. Displays the user interface, source video, and playback video, as well as operating information when the on-screen display is active.
ALT Button	Toggles alternative functions for the Soft Key buttons. It may be used in combination with the Control knob to reset a setting to its default. It may also be used to exit various screens and return to the live video screen.
MENU Button	Displays the Main menu. May also be used to exit various screens.
Soft Key Buttons	Multi-functional buttons. Each soft key button's function is displayed as a label on the LCD directly above the button.

Left Side Panel

The left side of the PIX-E5 provides various I/O ports for audio and video. The PIX-E5H is an HDMI only unit, so it does not have SDI ports.

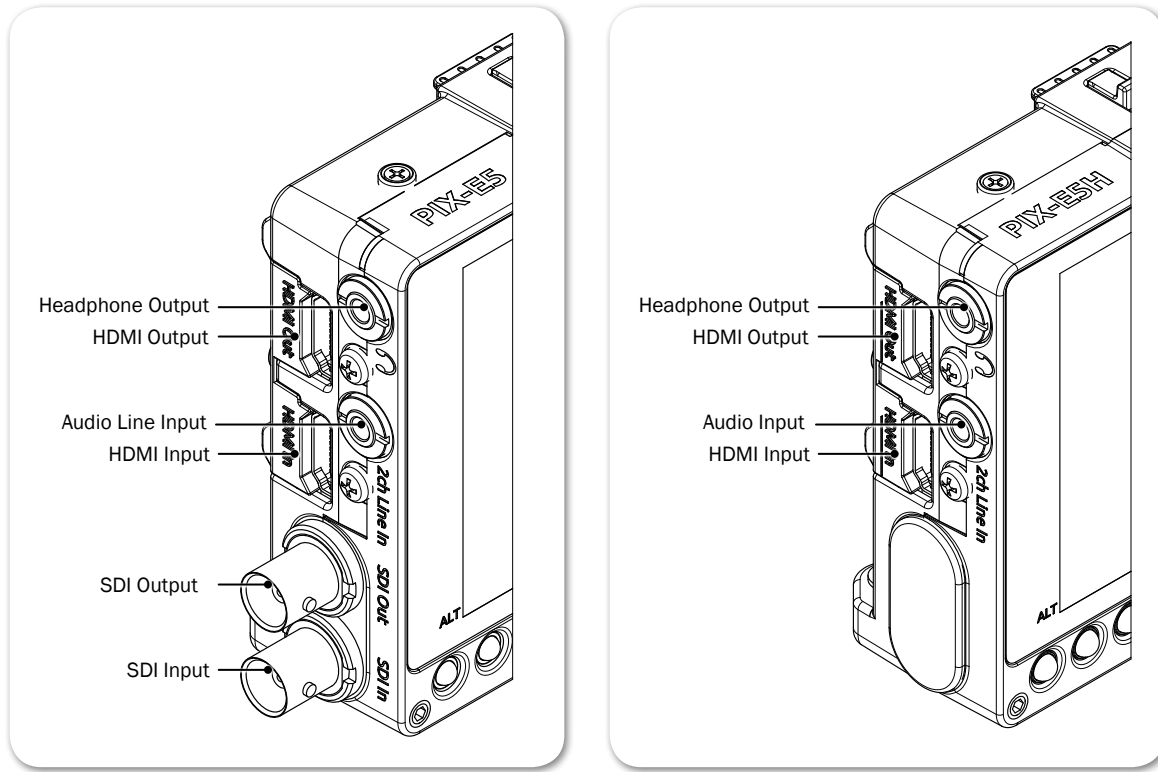

FEATURE	DESCRIPTION
Headphone Output	1/8-inch (3.5mm) unbalanced stereo headphone output.
HDMI Output	Outputs HDMI video with up to two channels of embedded audio.
Audio Line Input	1/8-inch (3.5mm) unbalanced, line-level, 2-channel input.
HDMI Input	Accepts HDMI (1.4a) signal with two channels of embedded audio. <i>ⓘ The monitor does not record or display content encoded with HDCP copy protection.</i>
SDI Output*	Outputs up to 8 channels of embedded audio.
SDI Input*	Accepts up to 8 channels of embedded audio.

* Applies to PIX-E5 only

Back and Bottom Panels

The back panel features two battery mounts and a USB connector for mounting a SpeedDrive. The bottom panels offers a 1/4-inch, 20-threaded mounting point to secure the monitor to cameras and other devices.

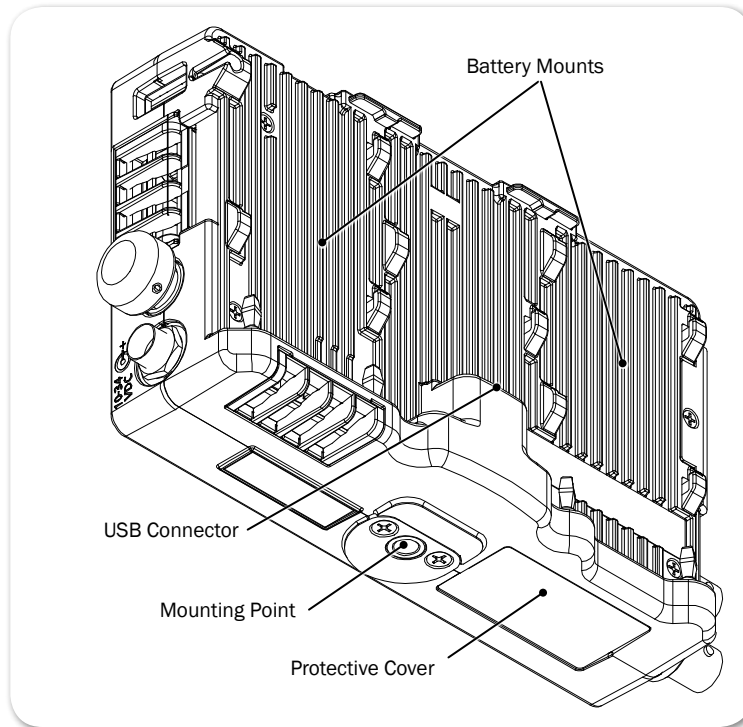

FEATURE	DESCRIPTION
Battery Mounts	Located on the left and right side of the back panel are two mounts for Sony® L-Series Lithium-ion batteries, or third-party batteries compatible with the mount.
USB Connector	Centered between the battery mounts on the back panel is the USB connector for a SpeedDrive with installed mSATA drive. ⓘ <i>The USB connector cannot be used with any USB-based drive.</i>
Mounting Point	Centered on the top and bottom panels, a 1/4-inch, 20 threaded, stainless-steel mounting point may be used to attach the monitor to a camera or other production gear, such as the PIX-ARM.
Protective Cover	This removable cover is attached with adhesive to the monitor's bottom panel and protects the connection used for integration with the optional PIX-LR accessory.

⚠ Caution regarding battery usage: There is danger of explosion if the battery is incorrectly replaced. Replace only with the same or equivalent type. Properly recycle batteries. Do not crush, disassemble, incinerate, dispose in a fire or expose batteries to high temperatures.

Right Side Panel

The right panel features a SD card slot, a Control knob, and ports for connecting external power or a peripheral USB keyboard.

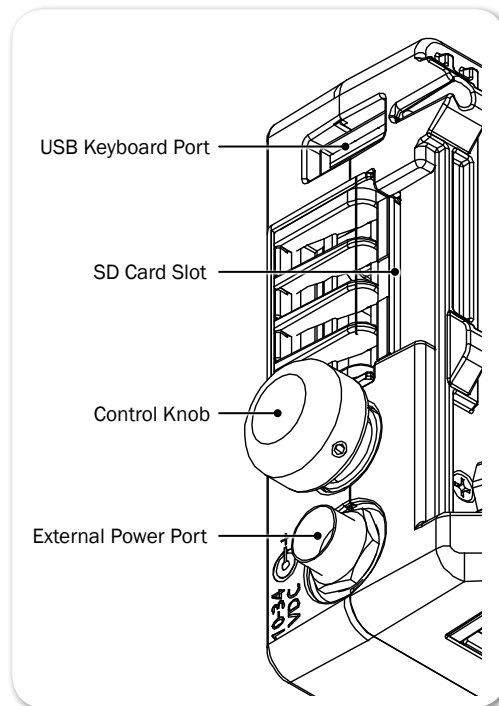

FEATURE	DESCRIPTION
USB Keyboard Port	Use this port to connect a USB keyboard for entering metadata and remote control.
SD Card Slot	Accepts standard SD cards (SDSC, SDHC, and SDXC) for loading firmware as well as saving and loading setup files.
Control Knob	Use the Control knob to navigate menu settings (by turning it) and selecting menu options (by pressing it in). It may also be used for scrolling across screen while in zoom mode.
External Power Port	Use to connect the PIX-E PSU. It accepts 10-34 VDC, threaded coaxial connector (pin positive, sleeve negative) with a 5.5 mm outer diameter and 2.1 mm inner diameter.

⚠ Caution regarding power supply: The PIX-E PSU must be connected to a protective earthing connection to ensure safety. The power supply's cord acts as the disconnect device. The cord must be readily accessible and remain readily operable.





Menus and Navigation

Whether working on the set or in the field, time is precious, and monitoring live recordings often requires quick adjustments in fast-paced workflows.

The PIX-E5 and PIX-E5H feature an on-screen display (OSD) and menus in an easy to navigate structure, with many options readily accessible via the touch screen or multi-functional soft key buttons.

The Main menu is one press of a button away with easy navigation via the Control knob or touch screen.

Topics in this section include:

- ▶ **Touch Screen and Tactile Controls**
- ▶ **Accessing the MAIN MENU Screen**
- ▶ **Toggling On-Screen Display Elements**
- ▶ **Toggling Soft Key Button Functionality**
 - ▶ Monitor Soft Keys
 - ▶ Record Soft Keys
- ▶ **Using Soft Key Menus**
- ▶ **Configuring the On-Screen Display**
- ▶ **USB Keyboard**

Touch Screen and Tactile Controls

Whether you want the quick efficiency of a touch-screen interface or prefer the tactile feedback of real buttons and want to keep the monitor's screen free of fingerprints, the PIX-E monitors offer a "best of both worlds" approach to user controls.

All PIX-E LCDs are touch-screen enabled, but the monitors also feature tactile buttons and a Control knob. Use the buttons to turn on or off monitor functions. Elements of menus and dialogs may be selected or adjusted by touching the screen or by using the Control knob, so you have the choice when it comes to navigating through the user interface.

While directions throughout this guide describe how to use the Control knob for navigation, touching the screen is often a quicker alternative.

Accessing the MAIN MENU Screen

The MAIN MENU screen displays an easy-to-navigate menu, organized with sub-menus, options, and parameters.

To access the MAIN MENU screen:

- ▶ Press the MENU button.

- ① *If you press and hold the MENU button, the Monitor menu appears across the lower portion of the screen.*

To navigate the Main menu with touch:

- ▶ Touch a menu item to access it.

To navigate the Main menu with the Control knob:

1. Turn the Control knob to move the highlight up or down the menu.
2. Press in the Control knob to access a highlighted option.

Sub-menus and their options are covered in more detail in sections related to those settings; however, the Main menu is provided with brief descriptions in the following table:

MAIN MENU	DESCRIPTION
Help	Displays a quick reference list of shortcut key combinations and their associated functions.
Recorder & Drives	Displays the settings relevant to recording and drive formatting.
Metadata	Displays the settings relevant to file-naming metadata stored in recorded files.
Video I/O	Displays the settings that define video input and output signals.
Audio	Displays the settings that define headphone warning bells and (optional) PIX-LR setup.
Timecode	Displays the settings that define the timecode mode.
System	Displays the system settings, such as date and time options.
Save/Load Settings	Displays the options for saving customized settings to external storage media and loading those settings or reverting the device back to its factory settings.

Toggleing On-Screen Display Elements

The LCD displays a live or playback video image and the OSD, providing vital information superimposed over the video.

The OSD is made up of two display elements, which may be viewed or hidden:

- **Soft key labels** — Located along the bottom of the screen, these identify the current function of the soft key button directly below each label.
- **Information bar** — Located along the top of the screen, this bar is superimposed over the video image and shows transport status, the timecode, ABS time, audio meters for channels 1 and 2, file name, a clock, and other status information for a SpeedDrive and power sources. An alternative view of the bar provides additional information, such as codec.

To show or hide soft key labels and/or the information bar:

- ▶ Press the Display soft key button. This button toggles through three display options:
 - Show both information bar and soft key labels

- Show soft key labels; hide information bar
- Hide both information bar and soft key labels

① *Holding down the Display soft key button for at least one second will show alternative data on the information bar, such as the codec being used, and a file's resolution and rate.*

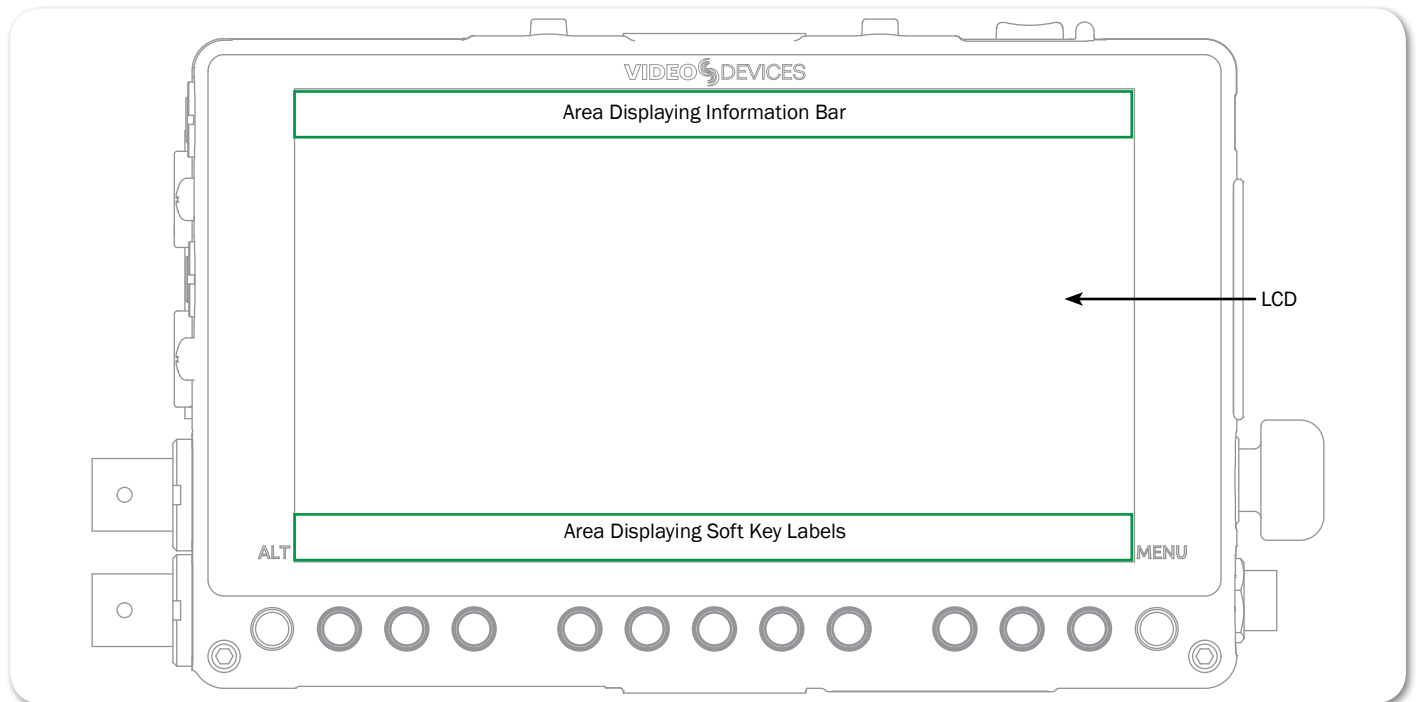

Toggle Soft Key Button Functionality

The primary functionality of soft key buttons is to toggle on or off monitoring tools, such as: peaking, zebras, scopes, and more.

However, soft key buttons are multi-functional; their alternative functionality includes accessing the File List and Audio screens, and acting as transport controls for recording and playback.

To toggle between monitor and record soft key functions:

- ▶ Press the ALT button. The displayed soft key labels above the buttons will change, indicating their current function.

① *The Display soft key label remains on-screen regardless of which functionality is set for the other soft key buttons.*

The following sections provide more details about what soft key labels appear for the primary monitor versus alternative record functionalities.

Monitor Soft Keys

When soft key buttons are set for primary monitor functionality, the following soft key labels appear and the buttons function as described:

LABEL	DESCRIPTION
Display	Hides or reveals OSD elements: soft key labels and/or the information bar.
False	Toggles on/off the display of the false colors exposure assist tool.
Zebra	Toggles on/off the display of zebra stripes exposure assist tool.
4-Way	Splits the screen into four quadrants, showing the video image in one quadrant and three scopes—waveform, vectorscope, and histogram—in the other three.
WFM	Toggles on/off the full-screen display of the waveform monitoring tool.
Vector	Toggles on/off the full-screen display of the vectorscope monitoring tool.
Hist	Toggles on/off the full-screen display of the histogram monitoring tool.
Zoom2x / Zoom4x	Toggles on/off the TapZoom functionality between different magnifications of the video image: 2x (200%) or 4x (400%). This setting also applies to zooming via use of the Control knob. ① <i>If TapZoom is disabled, the label for this soft key button will be NoZoom.</i>
Peak	Toggles on/off the display of peaking filter focus assist tool.
Marker	Toggles on/off the display of guide markers over the video image.

- ① Holding down most monitoring soft key buttons for more than a second will open a menu related to that button's functionality.

Record Soft Keys

When soft key buttons are set for alternate record functionality, the following soft key labels appear and the buttons function as described:

LABEL	DESCRIPTION
Display	Hides or reveals OSD elements: soft key labels and/or the information bar.
Audio	Displays the Audio screen. Track arm status, track name, input source, input gain, and input delay can be viewed and adjusted for every track. Also displays metering for all tracks.
Files	Accesses the Files screen, showing files recorded on the PIX-E5 as a list of clips.
Stop	Stops the recording or playback. When stopped, the label appears with a yellow background and a yellow square icon appears on the information bar. While stopped, pressing Stop reveals the next file name in the information bar.
Play / Pause	Starts playback. During playback, the label appears with a green background and a green arrow icon appears on the information bar. The timecode, absolute time, and file name also appear green. Pressing the button during playback will pause playback. While paused, the Pause soft key label flashes, and the Pause icon flashes on the information bar.

LABEL	DESCRIPTION
Rec	Starts the recording. While recording, the label appears with a red background and a red circle icon appears on the information bar. The timecode, absolute time, and file name also appear red.

Using Soft Key Menus

Commonly used settings are accessed via Soft Key menus. These menus differ from the Main menu because they do not take up the entire screen. Instead, they are superimposed over the lower portion of the screen, allowing any live video to remain visible. Also, unlike the Main menu, the Soft Key menus may be accessed during playback or while recording.

To access any Soft Key menu:

- ▶ Press and hold the button for 1 second. The button’s menu, if available, will appear.

Specific buttons that feature Soft Key menus include:

BUTTON	DESCRIPTION
MENU	Called the Monitor menu, it displays settings for headphones and the LCD, such as brightness, contrast, and so forth.
False	The False menu displays options for setting the false color mode.
Zebra	The Zebra menu displays settings and related options for zebras 1 and 2.
WFM	The WFM menu displays settings and related options for the waveform monitor.
Vector	The Vector menu displays settings and related options for the vector-scope.
Hist	The Hist menu displays settings and related options for the histogram.
Zoom	The Zoom menu displays options for enabling or disabling the TapZoom feature via the touch screen and zoom functionality via the Control knob.
Peak	The Peak menu displays settings and related options for peaking.
Marker	The Marker menu displays settings and related options for setting up guide markers.

① *Accessing a soft key menu for a monitor function will enable that monitor function if it is not already enabled. There is no such menu for the 4-Way soft key button. Also, there are no Soft Key menus available when soft key buttons are set to the record functionality.*

The layout of these menus varies. The simplest menu will consist of a single row of options. The active option is highlighted in green.

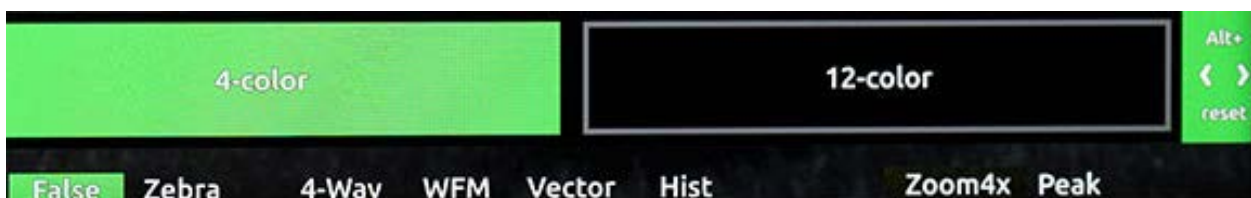

Other such menus will feature settings in a nested tabular format. The tab of

the active setting is outlined in green.



You can use the touch screen or Control knob to navigate soft key menus.

To use a Soft Key menu:

- Do either of the following:
 - Use the Control knob by turning it to navigate tabbed settings and related options. Press in the Control knob to make a selection, and turn it to adjust any values, such as sliders.
 - Touch the screen to select a tabbed setting or related option. Touch and swipe your fingertip along sliders to adjust any values.
- When finished modifying settings, exit the menu by pressing the soft key button again or touching elsewhere on the screen.

To reset the default of any Soft Key menu setting:

- With the menu's setting displayed, press and hold the ALT button while pressing in the Control knob.

Configuring the On-Screen Display

The look of the OSD may vary depending on the configuration of certain settings available in the Monitor menu. For instance, the brightness or contrast of the display image might need adjusting. Or perhaps, the background for the information bar and all soft key menus appears opaque instead of transparent when superimposed over the video image.

To configure the Monitor settings:

- Press and hold the MENU button for 1 second. The Monitor menu appears superimposed over the lower portion of the screen.
- Adjust the following settings as needed to achieve the look you want.

SETTING	DESCRIPTION	OPTIONS
See-Thru	Use this setting to adjust the opacity of soft key menus and the information bar by increments of 25%. Set to 0% for fully opaque and 100% for full transparency. This setting does not affect the soft key labels, which are superimposed with a fully transparent background. The default is 50%.	0 to 100%
Brightness	Use this setting to adjust the brightness of the display image by increments of 1%. The default is 0%.	-20 to 20%
Contrast	Use this setting to adjust the contrast of the display image by increments of 1%. The default is 100%.	0 to 200%
Chroma	Use this setting to adjust the chroma level of the display image by increments of 1%. The default is 100%.	0 to 200%
Backlight	Use this setting to adjust the backlight level of the LCD by increments of 5%. The default is 70%.	0 to 100%

① *The Monitor menu also provides settings for adjusting headphone source and levels. For more information, see [Configuring Audio Output](#).*

USB Keyboard

PIX-E monitors support the use of a standard USB keyboard connected to the USB A connector on the right panel of the chassis. The keyboard may be used to navigate menus, enter text, and perform various other functions.

CONTEXT	KEY	ACTION
All	Shift	ALT button
	M, F12	MENU button
	F1-F12	Soft Key buttons. F1 is the first button to the right of the ALT button, F2 is the next button to the Right, etc.
	CTRL + R	Record
	Space	Play/Pause
	CTRL + S	Stop
	Esc	Cancel / Go back
Live View	Enter	Enable TapZoom
Zoom mode	Enter	Switch between horizontal and vertical positioning.
	Up/Down arrow	Reposition center point
	Alt + Enter	Exit TapZoom
Audio screen & File screen	Up arrow	Move up one track or file
	Down arrow	Move down one track or file
	Enter	Select track or file
	Esc	Exit to main screen
Audio screen with track selected	Up arrow	Move one field to the right
	Right arrow	Move one field to the right
	Down arrow	Move one field to the left
	Left arrow	Move one field to the left
	Enter	Select field for editing

CONTEXT	KEY	ACTION
Audio screen with Delay field selected	Up arrow	Increment delay by 10 ms
	Down arrow	Decrement delay by 10 ms
	Enter	Accept edits and unselect both the edited field and the track
	Esc	Accept edits and unselect both the edited field and the track
Audio screen with Gain field selected	Up arrow	Increment gain by 1 dB
	Down arrow	Decrement gain by 1 dB
	Enter	Accept edits and unselect both the edited field and the track
	Esc	Accept edits and unselect both the edited field and the track
Audio screen with Source field selected	Up arrow	Select the next source up
	Down arrow	Select the next source down
	Enter	Accepts current selection and unselect both the edited field and track
	Esc	Accepts current selection and unselect both the edited field and track
On-screen keyboard displayed	Printable keys	Are entered into the text field
	Enter	Selects the currently highlighted button on the on-screen keyboard
	Esc	Rejects edits closes the on-screen keyboard
	Arrow keys	Move the highlight on the on-screen keyboard
	Backspace	Deletes one character to the left
	Del	Deletes one character to the right

PIX-Assist Monitoring Suite

The PIX-E5 and PIX-E5H are powerful, versatile field monitors designed for use with virtually any production camera.

Their LCD's accurate color representation and excellent off-axis visibility, even on very sunny days, provide a powerful visual aid for achieving precise focusing, exposure, color balance, and framing, enabling the cinematographer to achieve their creative vision.

The monitors feature the complete PIX-Assist™ suite of monitoring tools, offering the best graphical representation of your video signal so you can be sure what you see on the monitor is exactly what you want in a video recording.

Topics in this section include:

- ▶ **Overview**
- ▶ **Assist Tools**
 - ▶ Using False Colors
 - ▶ Using Zebras
 - ▶ Using Zoom
 - ▶ Using Peaking
- ▶ **Scopes**
 - ▶ Using the Waveform Monitor
 - ▶ Using the Vectorscope
 - ▶ Using the Histogram
- ▶ **Using 4-Way Monitoring**
- ▶ **Using Markers**
- ▶ **Resetting Monitor Defaults**

Overview

The PIX-Assist suite of monitoring tools consists of a collection of focus, exposure, and framing assist tools plus scopes. These tools affect the video signal displayed on the monitor, and the scopes provide a live graphical analysis of chrominance and luminance information in the video signal.

These monitoring features are controlled from soft key buttons, above which are soft key labels indicating the button's current functionality.

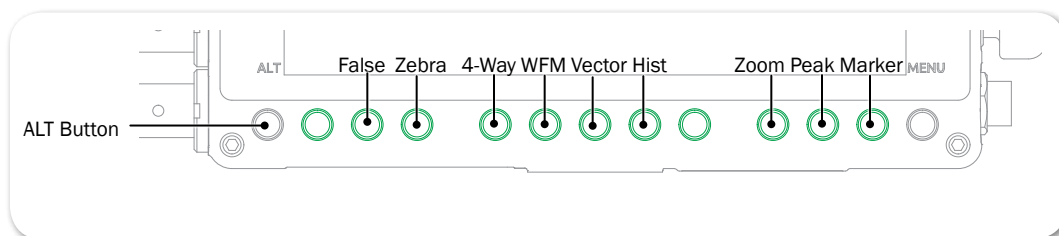

① *If the monitor functionality of soft keys is not displayed, press the ALT button.*

When a monitoring tool is activated, the label above the corresponding button appears with a green background.

Assist Tools

The assist tools are those used to aid focusing and making adjustments for exposure. The tools include: false colors, zebras, zoom, and peaking.

Using False Colors

False colors provides a quick way to achieve good exposure levels. They are typically used to indicate over- and under-exposed regions in the video, as well as aiding in setting exposure for skin tone and middle grey. The PIX-E monitors offer two modes: 4-color and 12-color.

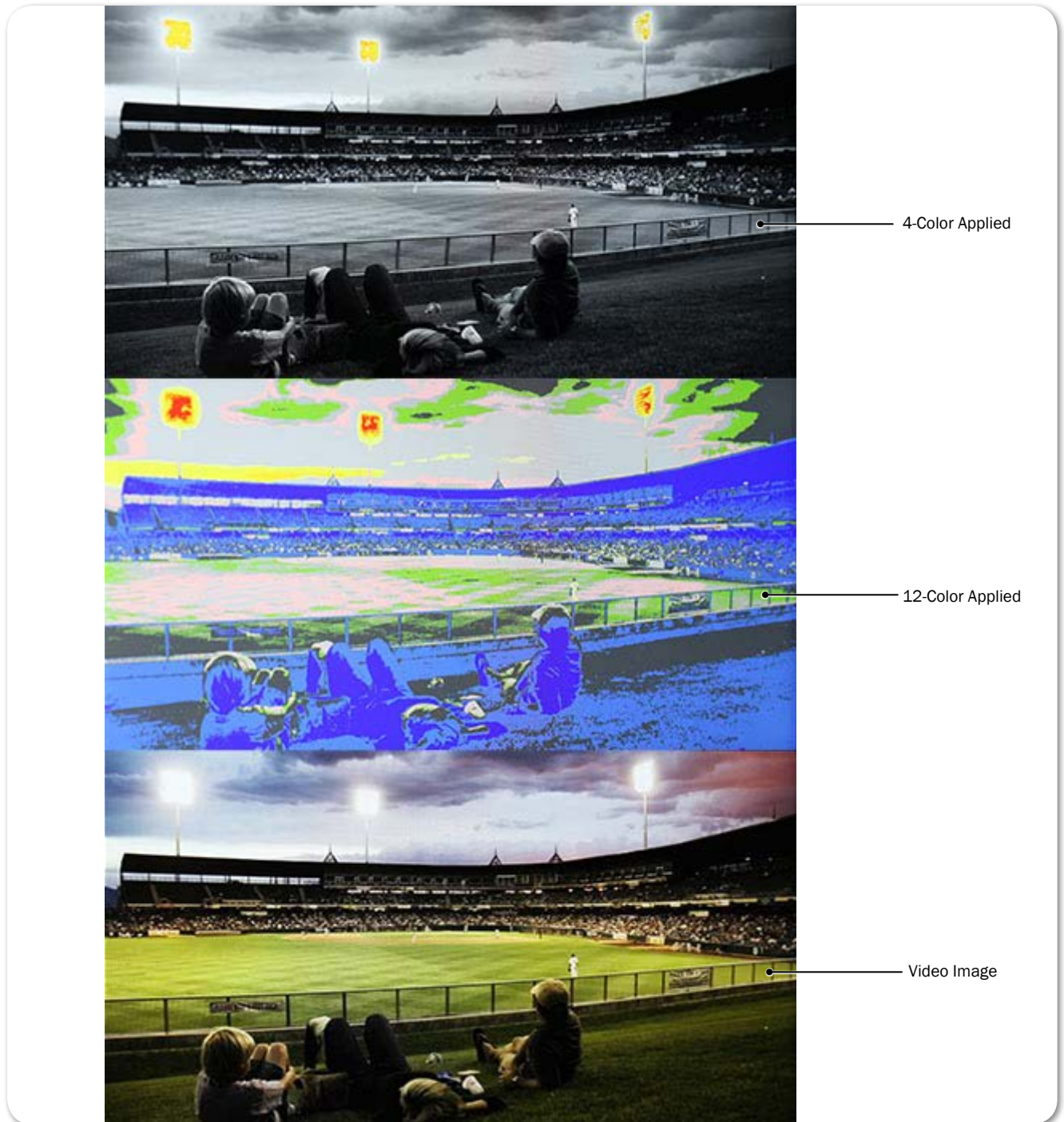

The 4-color mode is ideal for quickly identifying over- and under-exposed regions. Under-exposed regions are highlighted blue and over-exposed regions as yellow or red. All exposure levels in between are displayed as grey scale.

The 12-color mode is also used for identifying over- and under-exposed regions; however, it also provides a quick way to achieve correct exposure levels for skin tone and middle grey. For example, correctly exposed Caucasian skin tone typically shows as pink.

To enable or disable false color:

- ▶ Press the False soft key button.

To adjust false color settings:

1. Press and hold the False soft key button. The False menu appears.

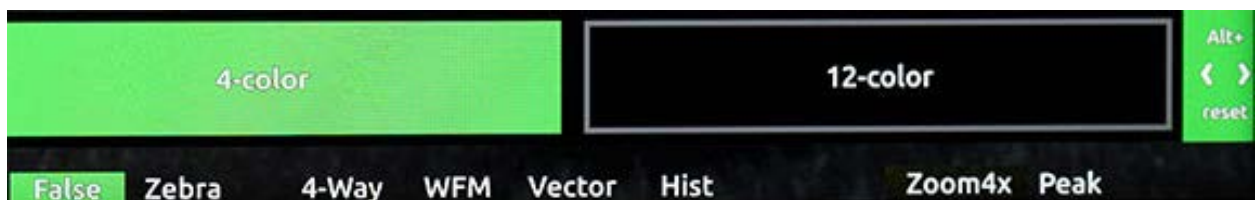

2. Use the touch screen or Control knob to change settings.

OPTIONS	DESCRIPTION														
4-color	The 4-step mode divides the monitor signal into 4 luminance ranges, assigning a color to all but one range; this range is displayed without chroma.	<table border="1"> <thead> <tr> <th>4-step</th> </tr> </thead> <tbody> <tr> <td>100-108 Red</td> </tr> <tr> <td>95-99 Orange</td> </tr> <tr> <td>3-98 N/A</td> </tr> <tr> <td>0-2 Blue</td> </tr> </tbody> </table>	4-step	100-108 Red	95-99 Orange	3-98 N/A	0-2 Blue								
4-step															
100-108 Red															
95-99 Orange															
3-98 N/A															
0-2 Blue															
12-color	<p>The 12-step mode divides the monitor signal into 12 luminance ranges, assigning a color to each one.</p> <p>Red and orange (95-108) ranges indicate over-exposure.</p> <p>Middle greys and skin tones typically fall in the green, pink, and medium to light grey (43-78) range.</p> <p>Blue and white (0-12) ranges indicate under-exposure.</p>	<table border="1"> <thead> <tr> <th>12-step</th> </tr> </thead> <tbody> <tr> <td>100-108 Red</td> </tr> <tr> <td>95-99 Orange</td> </tr> <tr> <td>85-94 Yellow</td> </tr> <tr> <td>79-84 Light Yellow</td> </tr> <tr> <td>59-78 Light Grey</td> </tr> <tr> <td>53-58 Pink</td> </tr> <tr> <td>49-52 Medium Grey</td> </tr> <tr> <td>43-48 Green</td> </tr> <tr> <td>23-42 Dark Grey</td> </tr> <tr> <td>13-22 Light Blue</td> </tr> <tr> <td>3-12 Blue</td> </tr> <tr> <td>0-2 White</td> </tr> </tbody> </table>	12-step	100-108 Red	95-99 Orange	85-94 Yellow	79-84 Light Yellow	59-78 Light Grey	53-58 Pink	49-52 Medium Grey	43-48 Green	23-42 Dark Grey	13-22 Light Blue	3-12 Blue	0-2 White
12-step															
100-108 Red															
95-99 Orange															
85-94 Yellow															
79-84 Light Yellow															
59-78 Light Grey															
53-58 Pink															
49-52 Medium Grey															
43-48 Green															
23-42 Dark Grey															
13-22 Light Blue															
3-12 Blue															
0-2 White															

3. Press the False soft key button again to exit.

Using Zebras

Zebras provides an alternative method for identifying exposure levels in an image. They appear as black and white diagonal stripes that are superimposed over regions of an image that exceed a threshold or specific value range of luminance. PIX-E monitors have three modes: Zebra 1, Zebra 2, and Zebra 1+2.

The following image shows both zebra 1+2 overlays with default settings.



Zebra 1 stripes are forward leaning and are typically set to identify a particular brightness range (value +/-5%), such as skin tones or mid tones.

Zebra 2 stripes are backward leaning and are typically set to identify when a specific brightness level is exceeded. They are often set to identify over-exposed image or when textures and details in whites start to get lost.

Zebra 1+2 simultaneously superimposes both on the video image.

To enable or disable zebras:

- ▶ Press the Zebra soft key button.

The button is a toggle, so pressing it a second time turns off the zebra overlay. When enabled, the Zebra soft key label appears with a green background.

To adjust zebra settings:

1. Press and hold the Zebra soft key button. The Zebra menu appears.



2. Use the touch screen or Control knob to change settings.

SETTING	DESCRIPTION	OPTIONS
Select Zebra Display	Sets which zebra is displayed when zebras are enabled.	<ul style="list-style-type: none"> • Zebra 1 • Zebra 2 • Zebras 1 + 2
Zebra 1 Level	The luminance range where Zebra 1 will be displayed. The top of the range is 5% above this setting, and the bottom of the range is 5% below.	<ul style="list-style-type: none"> • 0% - 105%
Zebra 2 Threshold	Zebra 2 will be displayed for signal above this threshold.	<ul style="list-style-type: none"> • 0% - 108%

3. Press the Zebra soft key button to exit.

Using Zoom

For fast and precise focusing on both static and moving subjects, PIX-E monitors provide 2x and 4x magnification and the ability to rapidly adjust the center point of focus. Zoom can be controlled using the touch screen or the Control knob.

TapZoom™ is the fastest way to zoom in and out on a subject. Utilizing the PIX-E monitors' touch screen, TapZoom lets focus pullers and camera operators check focus by simply tapping a point on the video image to zoom in on a target. A second tap zooms back out.

For those who prefer to not use the touch screen, zoom can also be activated using the Control knob.

To zoom in on a point of interest:

- ▶ Tap that point in the image.
- ▶ Press in the Control knob.

To zoom out to full image:

- ▶ Tap center of screen.
- ▶ Press ALT+Control knob.



[SEE DEMO VIDEO](#)

Magnification is controlled by a Zoom soft key button, and the soft key label displays the current setting related to the Zoom feature.

SOFT KEY LABEL	DESCRIPTION
Zoom2x	When set to 2x, activating zoom will zoom with 200% magnification.
Zoom4x	When set to 4x, activating zoom will zoom with 400% magnification.
NoZoom	Indicates when zoom functionality is disabled.

When zoomed in, the monitor centers the screen on the tapped target, displays the word ZOOMED in red, and provides a rectangular locator graphic to pinpoint zoomed area within the full image. That location is known as the center point. Below the locator graphic is POS, or repositioning options, with arrows indicating the direction in which you can move that center point.

To reposition the center point:

- ▶ Swipe your fingertip across screen to move the zoomed-in image around on the screen. The center point is repositioned accordingly.
- ▶ Turn the Control knob to reposition the center point. Press the knob in to switch between horizontal or vertical positioning.

Targets in Motion

Repositioning the center point works well for stationary subjects, but if a subject moves, a quick tap in certain zones can help recenter the zoomed view, keeping your shot on target. The screen is split into nine zones.

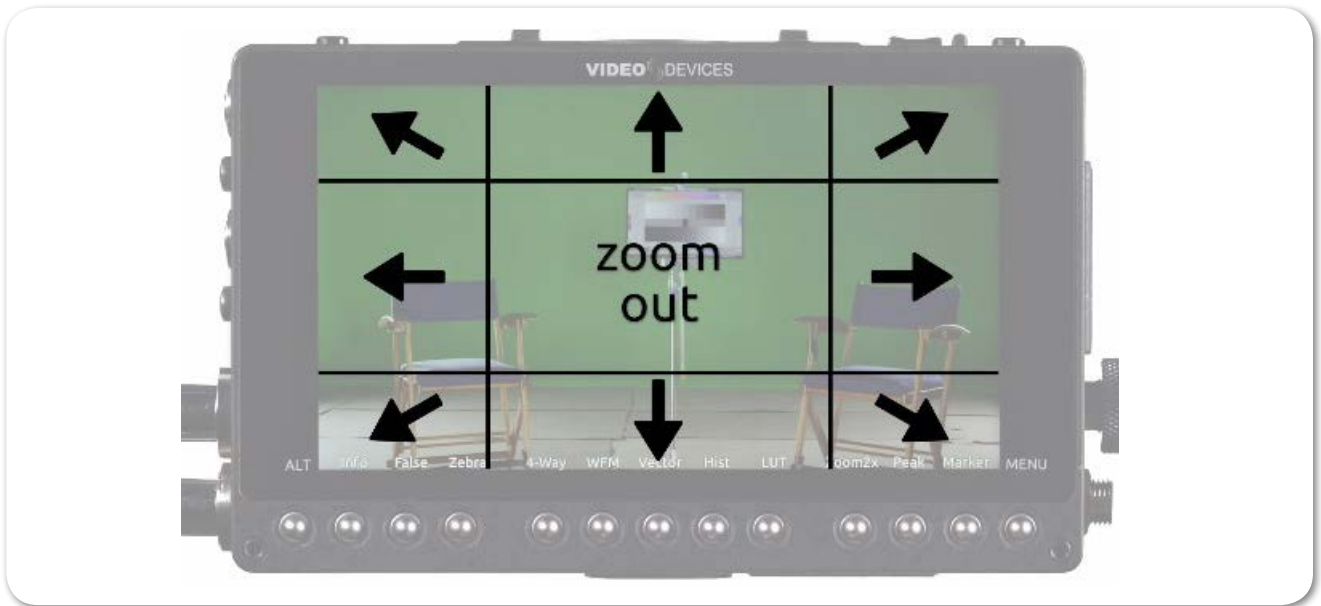

While zoomed in, you may tap toward the edges of the screen to follow a moving subject around within a shot, or tap the center of the screen to return to a non-magnified view of the overall shot.

Enabling or Disabling Zoom

Zoom is a feature that may be disabled.

To enable or disable Zoom:

1. Press and hold the Zoom soft key button. The Zoom menu appears superimposed over the lower portion of the screen.
2. Do one of the following:
 - ▶ Select Zoom Enabled to turn on zoom functionality.
 - ▶ Select Zoom Disabled to turn off zoom functionality.

When disabled, the Zoom soft key button no longer toggles between magnification settings, and its soft key label displays NoZoom.

Using Peaking

Peaking is a focus-assist tool that makes it easy to discern an object in focus by visually highlighting sharp edges. It can also be used in conjunction with zoom to rapidly achieve ultra-precise focus.

PIX-E provides a range of options to help make the sharp focused edges stand out regardless of the color and content of the video image. These options include user-customizable peaking sensitivity, color, throb, background contrast and background color.

The following comparison demonstrates the effect of peaking (shown in red) on an monochrome image with a shallow depth-of-field and a short focal length

(top) and the same image with a longer focal length (bottom).

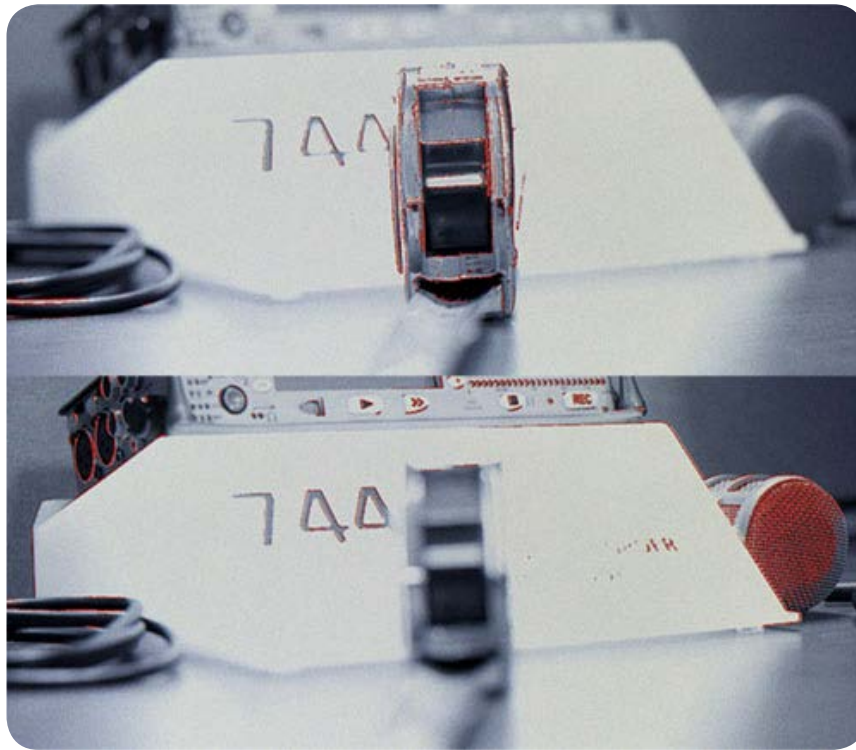

To turn on peaking:

- ▶ Press the Peak soft key button.

To adjust various settings related to peaking:

1. Press and hold the Peak soft key button. The Peak menu appears.



2. Use the touch screen or Control knob to change settings.

SETTING	DESCRIPTION	OPTIONS
Peaking Sensitivity	Use to define the sensitivity level for peaking. The lower the value, the less sensitive the peaking filter will be to non-sharp edges. The default is 50%	<ul style="list-style-type: none"> • 5% - 100%
Peaking Color	Choose the color to be used to highlight the sharp edges in a video image. To help the edges stand out, use a color that is not dominant in the image. The default color is Red.	<ul style="list-style-type: none"> • Red • Green • Blue • White • Yellow

SETTING	DESCRIPTION	OPTIONS
Peaking Throb	Set the peaking color to flash by turning this setting on and setting the speed. The default is Off.	<ul style="list-style-type: none"> • Off • Slow • Fast
Background Contrast	Sets the contrast of the background image. Lower the value to help the highlights be more visible. The default is 100%.	<ul style="list-style-type: none"> • 0% - 100%
Background Color	Sets the background image as Color or Monochrome. The default is Color.	<ul style="list-style-type: none"> • Color • Monochrome

3. Press the Peak soft key button again to exit.

Scopes

Scopes provide cinematographers and videographers the ability to accurately set exposure and color balance as well as make creative choices about the look of a scene.

PIX-E monitors offers three types of scope: the waveform monitor, the vector-scope, and the histogram. Each scope plots color and/or brightness information onto a graph which can be viewed full screen over an opaque background or superimposed over the video image. There is also a 4-way monitoring mode for viewing multiple scopes with the video image.

Using the Waveform Monitor

The waveform monitor (WFM) is a tool for checking and aiding in setting exposure levels both for brightness and color. Its precision graticule provides more detail and accuracy than either false colors or zebras. Use WFM to check exposure for skin tone, consistent background lighting, background separation on green screen shots, and for avoiding over-saturated colors.

The WFM's vertical axis ranges from -10% to 110% and represents brightness (luma) or color (chrominance) levels for each pixel in an image. 100% corresponds to nominal white and 0% to black. The -10% and 110% limits allow for monitoring of super blacks and whites.

The WFM's horizontal axis corresponds to the position of image content going from left to right.

The monitor provides four WFM modes: Luma (white), Luma (green), RGB Overlay, and RGB Parade.

The following table provides illustrative examples for each of these modes:

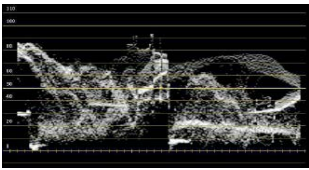
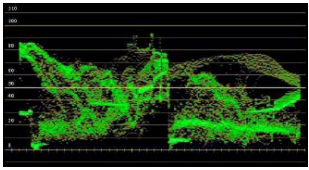
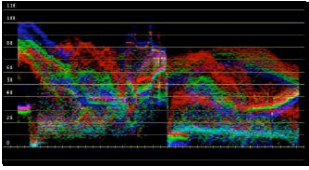
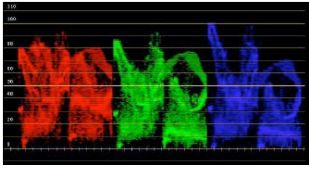
TYPE	EXAMPLE	DESCRIPTION
Luma (white)		Displays luminance only trace in white or green. Use to: <ul style="list-style-type: none"> accurately set exposure for skin tone where typical range is 45% (darker tones) to 60% (lighter tones). help to set consistent background lighting. For example, a uniform background lighting will appear as an approximately flat horizontal trace from left to right.
Luma (green)		
RGB Overlay		Displays red, green, and blue (RGB channels) color information overlaid one over another or horizontally, one after another: red, green, and then blue. Use to: <ul style="list-style-type: none"> check if RGB levels are clipping. This information may not show up in Luma mode. check white balance. RGB levels should be the same. check adequate separation between green, red and blue for green screen shots.
RGB Parade		

To view/hide the waveform monitor:

- ▶ Press the WFM soft key button.

The button is a toggle, so pressing it a second time turns off waveform.

To adjust percentage of intensity (trace brightness) of the WFM:

- ▶ While viewing the WFM, rotate the Control knob. The level is displayed on screen next to the Control knob.

To adjust waveform monitor settings:

1. Press and hold the WFM soft key button. The WFM menu appears.
2. Use the touch screen or Control knob to change settings.

SETTING	DESCRIPTION	OPTIONS
Waveform Type	The type of waveform monitor to display.	<ul style="list-style-type: none"> Luma (white) Luma (green) RGB Overlay RGB Parade
Background Video Contrast	The contrast level of the background video when monitor is displayed. The default is 35%. ⓘ For a black background, adjust to 0%.	<ul style="list-style-type: none"> 0% - 100%

Using the Vectorscope

The vectorscope is a circular graphical tool for monitoring color (chrominance) information. It can be used for helping eliminate unwanted color casts (offsets), checking white and black balance, ensuring color saturation falls within a legal broadcast color gamut, and for making creative choices about overall look.

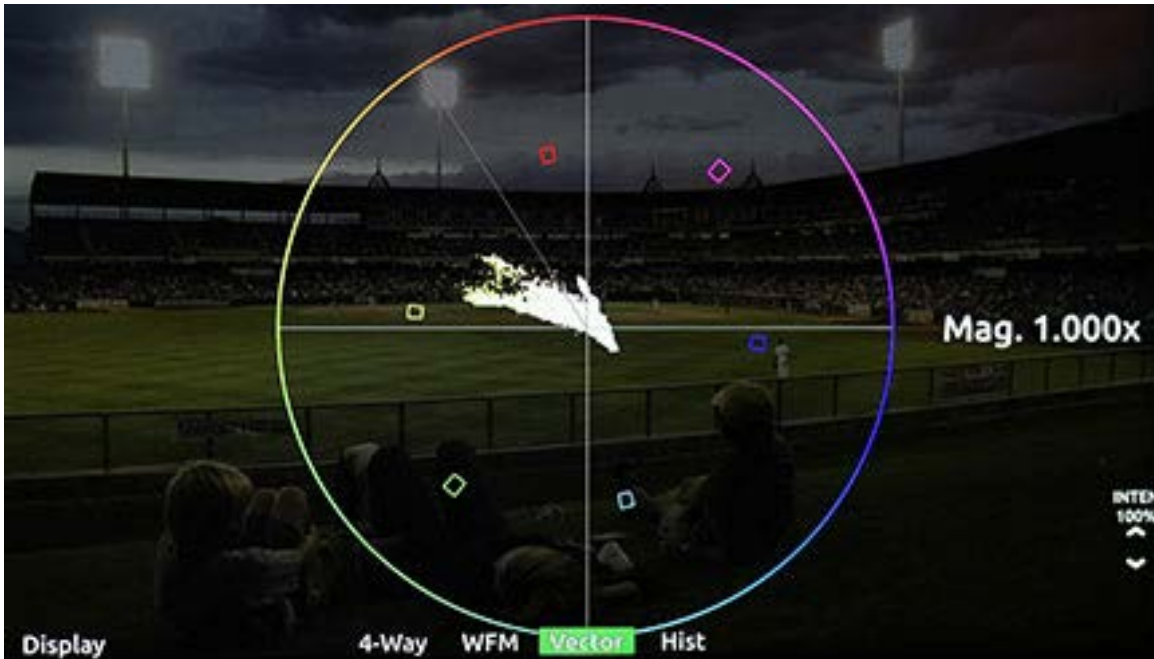

Color saturation is determined by the distance from the center of scope - the more saturated (vivid) a color, the further its trace reach is from the center. A greyscale image should appear as a dot in the center of the scope.

Color hue is determined by the direction or angle of the trace. Small boxes represent target values for fully saturated REC 709 primary and secondary color bars (red, green, blue, yellow, magenta, cyan). The line between the red and yellow target boxes that runs from center to outer circumference indicates skin tone.

- ① *Tip: To quickly check for color offset, view the vectorscope whilst performing a white and/or black balance. The trace should appear as a fuzzy dot (for white) or smaller dot (for black) in the center of the scope.*

To view/hide the vectorscope:

- ▶ Press the Vector soft key button.

To adjust percentage of intensity (trace brightness) of the vectorscope:

- ▶ Rotate the Control knob while viewing the vectorscope. The level is displayed on screen next to the Control knob.

To adjust vectorscope settings:

1. Press and hold the Vector soft key button. The Vectorscope menu appears.

2. Use the touch screen or Control knob to change settings.

SETTING	DESCRIPTION	OPTIONS
Vectorscope Magnification	Set the magnification multiplier of the vectorscope.	• 1.000x - 5.000x
Background Video Contrast	The contrast level of the background video when waveform monitor is displayed. ① For a black background, adjust to 0%.	• 0% - 100%

Using the Histogram

The histogram is a tool for checking overall brightness (luma) or color level (chrominance) within an image. It displays how many pixels there are at each brightness or color level. The horizontal axis represents luma level with black being on the left and white on the right. The vertical axis represents the relative number of pixels at that luma level. Use it to quickly determine that you are capturing the full dynamic range - most pixels should be distributed broadly around the center of the horizontal axis, not hard left (under-exposed) or hard right (over exposed).

The horizontal range of the histogram is -10% to 110%, matching the vertical range of the WFM, where 0% is legal black and 100% is legal white. The -10% and 110% limits allow for monitoring full range 'super blacks' and 'super whites'.

The monitor provides 4 histogram modes: Luma (white), Luma (green), RGB Overlay, and RGB Parade. The following table provides illustrative examples for each of these modes:

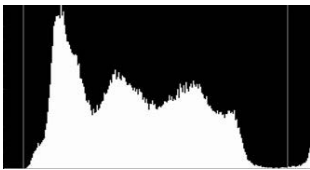
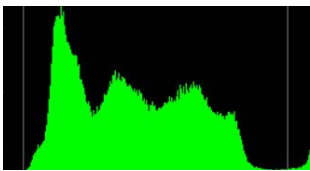
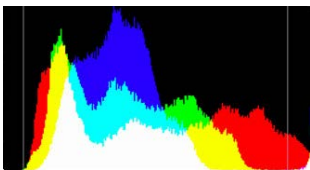
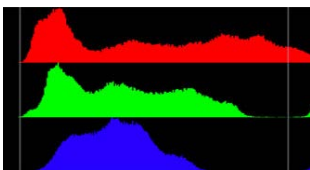
TYPE	EXAMPLE	DESCRIPTION
Luma (white)		Displays luma only trace in white.
Luma (green)		Displays luma only trace in green, offering a look reminiscent of green-screen oscilloscopes.
RGB Overlay		Displays RGB pixel distribution overlaid, one over another, as a horizontal trace.
RGB Parade		Displays RGB pixel distribution overlaid vertically one after another: red first, green second, and then blue.

To view/hide the histogram:

- ▶ Press the Hist soft key button.

To adjust histogram settings:

1. Press and hold the Hist soft key button. The Vectorscope menu appears.
2. Use the touch screen or Control knob to change settings.

SETTING	DESCRIPTION	OPTIONS
Histogram Type	Sets the type of histogram to display.	<ul style="list-style-type: none"> • Luma (white) • Luma (green) • RGB Overlay • RGB Parade
Background Video Contrast	The contrast level of the background video when waveform monitor is displayed. <i>ⓘ For a black background, adjust to 0%.</i>	<ul style="list-style-type: none"> • 0% - 100%

Using 4-Way Monitoring

4-Way monitor mode splits the screen into 4 quadrants, simultaneously displaying the video signal, histogram, waveform, and vectorscope. This provides a great overview of exposure and color attributes of the incoming video.

The following image shows an example of the display while in 4-way monitoring mode.

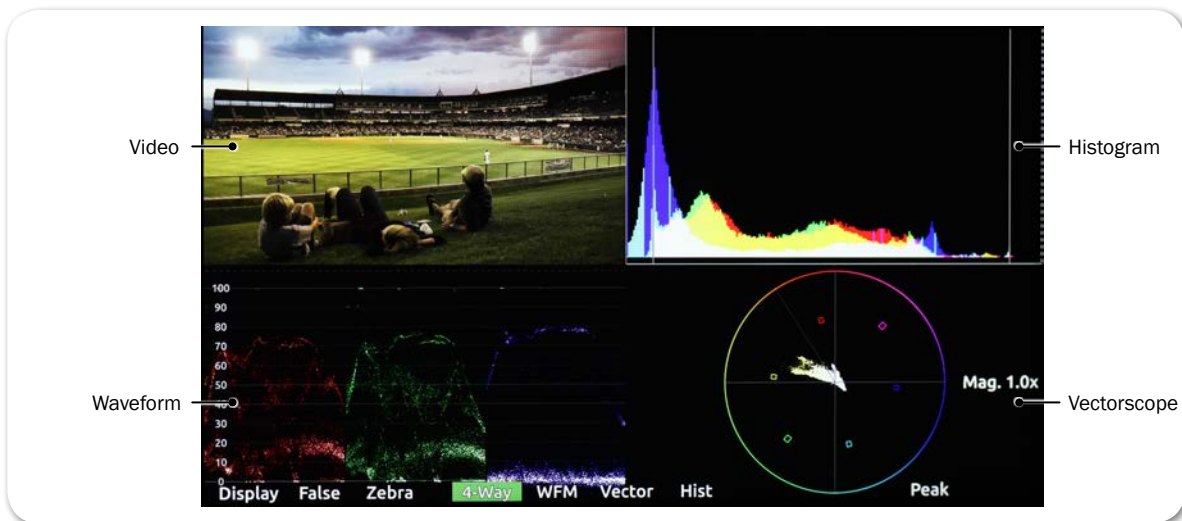

When in 4-way monitoring, a tap on any one of the four quadrants will enlarge the view displayed in that quadrant to full screen.

[SEE DEMO VIDEO](#)

To begin 4-way monitoring:

- ▶ Press the 4-Way soft key button.
- ▶ Tap the screen while viewing the full-screen histogram, vectorscope, or waveform monitor.

The overlay monitoring assist tools are still available when 4-way is displayed. For instance, you can turn on 4-way monitoring and view the video in the top left quadrant with peaking, false color, or zebras overlaid on the image.

To exit 4-way monitoring:

- ▶ Press the 4-Way soft key button again.
 - ▶ Tap any one of the four quadrants to expand that view full screen.
- ① *While a tap will expand one of the three scopes full screen, a second tap will toggle back to 4-way monitoring. That is not the case with the video quadrant; a tap there will exit 4-way and restore full screen viewing of the video signal. A second tap afterward will, if TapZoom is enabled, zoom in on the image.*

Using Markers

Guide markers are used to help frame and compose shots and define safe areas. The PIX-E monitors feature three different types of markers: frame, grid, and a center indicator.

The center indicator may be a dot or a cross, or both, and is used to mark the center point of a shot.

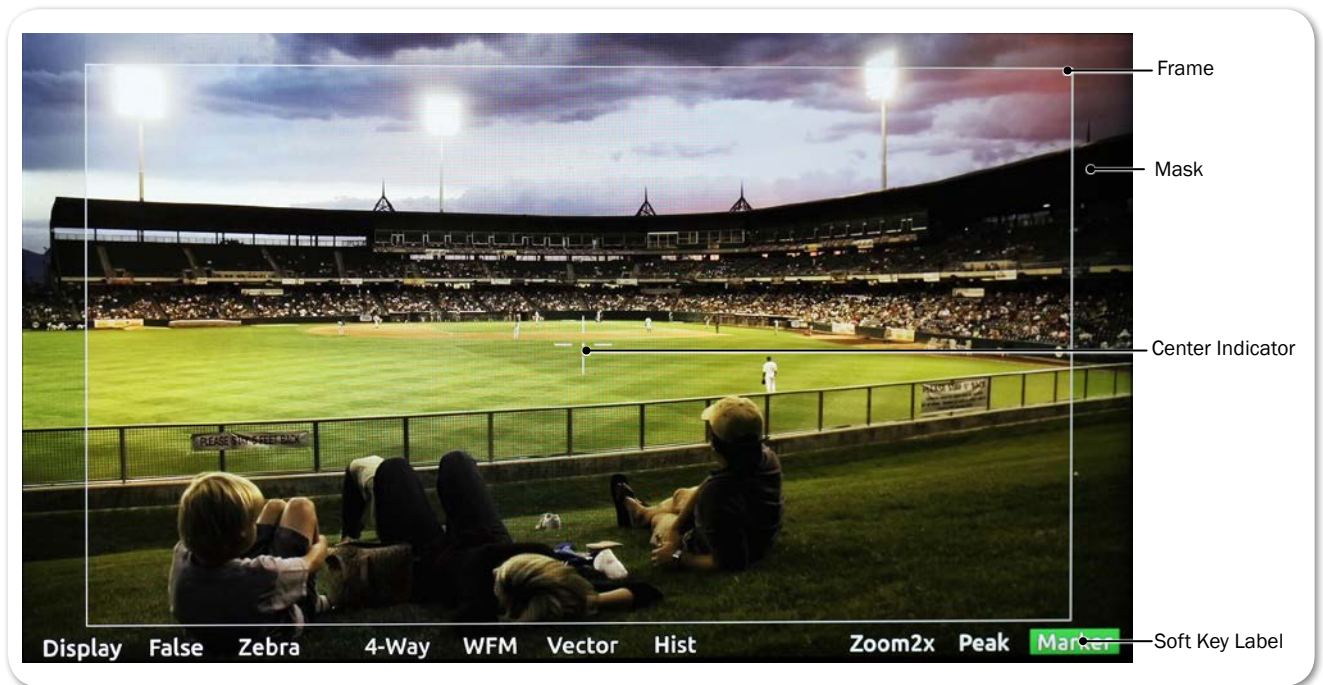

A frame marker is a thinly lined rectangle used to “frame” the shot. The frame may be customized to match the aspect ratio of the video, such as 16:9 for high-definition television. The area within the rectangular frame is safely “inside” the shot; the area outside the rectangle is the mask, which is considered “outside” the shot. There are two frame markers available on the monitor, which may be configured separately.

A grid marker divides up the frame into thirds or quarters, forming a grid pattern.

To show or hide markers:

- ▶ Press the Marker soft key button, which toggles the display of markers on or off. The Marker soft key label appears with a green background when markers are displayed.

① *Turning off all individual markers via their respective settings disables the Marker soft key button.*

With Markers enabled, all markers that are turned on will be visible in the video monitor. Each type of marker is enabled via its respective settings section.

To adjust marker settings:

1. Press and hold the Marker soft key button. The Marker menu appears superimposed over the lower portion of the screen.
2. Do one of the following:
 - ▶ Use the touch screen to view and change settings.
 - ▶ Turn and press the Control knob to select and change settings.

Markers have three main settings—Frame 1, Frame 2, and Center & Grid, each with its own sub-settings and options.



Frame 1 and Frame 2 have identical sub-settings—Display, Size, Color, Position, and Mask See-Thru—as described in the following table:

SETTING	SUB-SETTING	DESCRIPTION	OPTIONS
Frame 1 / Frame 2	Display	Use this setting to adjust the marker's aspect ratio.	<ul style="list-style-type: none"> • Off • 17x9 • 16x9 • 14x9 • 4x3 • 1.85:1 • 2.4:1 • Custom Aspect

SETTING	SUB-SETTING	DESCRIPTION	OPTIONS
	Size	Use this setting to adjust the percentage of the screen making up the inside area of the frame. For instance, if set to 90%, then the rectangular frame will make up 90% of the screen, while 10% will be masked out around the outer perimeter.	<ul style="list-style-type: none"> • 1% - 100%
	Color	Use this setting to adjust the color of the rectangular line forming the frame.	<ul style="list-style-type: none"> • White • Light Gray • Gray • Dark Gray • Black • Red • Green • Blue
	Position	Use this setting to position the frame on the screen.	<ul style="list-style-type: none"> • Centered • Top • Custom Position
	Mask See-Thru	Use this setting to adjust the opacity of the masked area outside the rectangular frame. Set to 0% for fully opaque and 100% for full transparency.	<ul style="list-style-type: none"> • 0% - 100%
Center & Grid	Center	Use this setting to enable the display of a cross and/or dot, superimposed at the center point of the video image.	<ul style="list-style-type: none"> • Off • Cross • Dot • Cross+Dot
	Center Color	Use this setting to adjust the color of the cross and/or dot, if used.	<ul style="list-style-type: none"> • White • Light Gray • Gray • Dark Gray • Black • Red • Green • Blue
	Grid	Use this setting to enable the display of a grid marker pattern of lines, superimposed over the video image. If set to 1/3, the screen is divided into a grid of 9 squares. If set to 1/4, the screen is divided into a grid of 12 squares. <i>① The grid, if enabled, will only appear within Frame 1. Grid markers do not apply to Frame 2.</i>	<ul style="list-style-type: none"> • Off • 1/3 • 1/4
	Grid Color	Use this setting to adjust the color of the grid lines if that marker pattern is used.	<ul style="list-style-type: none"> • White • Light Gray • Gray • Dark Gray • Black • Red • Green • Blue

Resetting Monitor Defaults

Restoring factory defaults via the Main menu resets all settings for all features on the monitor, but settings can be reset on an individual basis.

To restore a setting to factory default:

1. Open the soft key menu and navigate to view the setting you want to reset.
2. Press and hold the ALT button, while pushing in the Control knob.

This only resets one setting at a time, and not all settings available in the menu.



Storage

The PIX-E monitors can accept a SpeedDrive and a high-capacity SD memory card.

Both media can be easily removed from the monitor and inserted into standard USB or SD ports on computers, making the transfer of files easy and efficient.

PIX-E recorders format and write to an exFAT file system. The exFAT file system is readable and writable by all current major operating systems.

① *A list of storage devices approved for use with PIX-E monitors is available at: www.videodevices.com/approved*

Topics in this section include:

- ▶ **SpeedDrive**
- ▶ **SD Memory Card**
- ▶ **Metadata and File Name Format**
 - ▶ File Name Formats
- ▶ **Formatting Storage Drives**
- ▶ **Working with Files**
 - ▶ Deleting Recorded Files
 - ▶ Transferring Files to a Computer

SpeedDrive

The PIX-E5 writes Apple ProRes video files to SpeedDrive™ media. The SpeedDrive is a portable enclosure for a Mini-SATA (mSATA) drive with a USB 3.0 interface. The SpeedDrive ships with a 240GB mSATA drive installed or as an enclosure only.

ProRes 4k video recording produces an extremely high data rate which produces quite a bit of heat no matter what recording medium. The SpeedDrive enclosure is expressly designed to wick the heat away from the SSD via its thermally conductive gap-pad and heat sink. Though the SpeedDrive can be very warm to the touch, this is by design to keep the SSD as cool as possible.

To attach a SpeedDrive to the monitor:

1. Place the SpeedDrive so that the USB plug lines up to the USB connector on the back of the monitor.
2. Depress the spring-loaded retainer clip, located at the back edge of the monitor's top panel. Only one of two clips is used to hold the SpeedDrive, and it is labeled SSD.
3. Slide the SpeedDrive into the USB connector.

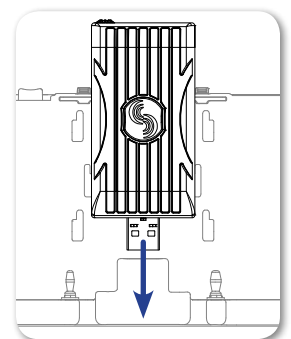

[SEE DEMO VIDEO](#)

The retainer clip will spring into the notch on the SpeedDrive with a click, indicating the SpeedDrive is securely attached to the monitor.

The storage volume will then be available on the PIX-E interface and appear as Drive 1 (D1) on the information bar.

- ① *Before recording to a SpeedDrive, it must be formatted by the monitor. For more information, see [Formatting Storage Drives](#).*

To remove a SpeedDrive:

1. Depress the left retainer clip, labeled SSD, holding the SpeedDrive in place.
2. Carefully slide the SpeedDrive out of the USB connector.

SD Memory Card

The monitor can save and recall its settings on a Secure Digital (SD) flash memory card. It accepts these cards:

- Standard-capacity (SDSC: 1MB - 2 or 4GB)
- High-capacity (SDHC: 2GB - 32GB)
- Extended-capacity (SDXC: 32GB - 2TB)

To install the SD card:

- ▶ Slide the SD card into the SD Memory Card slot on the right panel of the monitor.

- ① *Before saving setup files to an SD card, it must be formatted by the monitor. For more information, see [Formatting Storage Drives](#).*

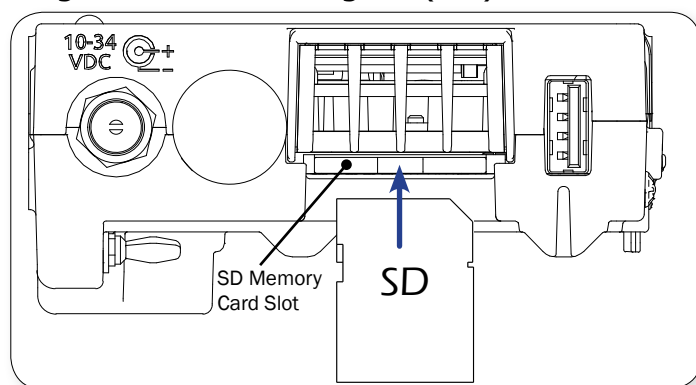

Metadata and File Name Format

The monitor lets the user enter scene, take, camera ID, reel, and clip information. Files generated by the monitor are named according to this information, making it easy for post production to identify recordings. These metadata options are located in the Metadata section of the Main menu.

To view or modify Metadata settings:

1. Press the MENU button.
2. Select Metadata.
3. Use the touch screen or Control knob to select and modify the settings as needed.

SETTING	DESCRIPTION	OPTIONS
Scene/Shot	Accepts alphanumeric values. Use this metadata field to indicate a descriptive name for the current scene or shot. A change to the Scene/Shot value will automatically reset the Take value to 1.	<ul style="list-style-type: none"> Text entry
Take	Sets numeric values only. Use this metadata field to indicate what take number the clip is, relative to the scene. This field can be set manually and will increment each time a new file is recorded. A change to the Scene/Shot value will reset Take to 1.	<ul style="list-style-type: none"> 1-999
CamID	Sets a single alpha character (A - Z). Use this metadata field to indicate which physical camera, in a multi-cam production, shot the content for the take.	<ul style="list-style-type: none"> A-Z
Reel	Accepts alphanumeric values. Use this metadata field to indicate what reel the recording is part of; a reel is a container for all assets generated during a recording session or day's work. A change to the Reel value will reset the Clip value to 1.	<ul style="list-style-type: none"> Text entry
Clip	Accepts numeric values (1-999). Use this metadata field to indicate what clip number the recording is. This field can be set manually and will increment each time a new file is recorded. A change to the Reel value will reset Clip to 1.	<ul style="list-style-type: none"> 1-999
File Name Format	Use this field to set the naming format for files. For more information, see "File Name Formats" on page 41.	<ul style="list-style-type: none"> Drive-Reel-Clip Reel-Clip CamID-Reel-Clip Reel-Scene-Take Scene-Take

File Name Formats

Files are named according to the File Name Format setting, accessed via Main menu > Metadata. Format options for file names includes various combinations of the metadata fields: CamID, Reel, Scene/Shot, Take, and Clip. These descriptive file name formats make it easy to identify recordings when imported into a nonlinear editor.

Formatting Storage Drives

Before using SD and SpeedDrive media, they must be formatted with the monitor.

① *PIX-E monitors over-provisions drive space by 10%.*

To erase/re-format a drive:

1. Connect the drive to be formatted.
2. Press the MENU button to view the Main menu.
3. Turn and press the Control knob to select Recorder & Drives > Erase/Re-format Drive.
4. Turn and press the Control knob to select the sub-option associated with the drive for formatting. Sub-options include: SpeedDrive, SD Card, or Both drives.
5. A cautionary confirmation dialog will appear on screen asking if you want to continue. Select Yes to continue. An on-screen keyboard appears.
6. Either accept the default volume name (PIX-E) or use the keyboard to enter a new volume name.
7. Select OK to continue.

Working with Files

Files recorded on the monitor are compiled in the SpeedDrive File List, as a list of clips arranged chronologically. The total size (in GB), created date / time, and duration of each file is provided in the list.



The screenshot shows a black background with the title "SpeedDrive File List" in white. Below the title is a table with four columns: Name, Size, Date, and Duration. The table contains four rows of data. The first row is highlighted in blue. At the bottom center of the screen, the word "Play" is visible.

Name	Size	Date	Duration
PIX-E-001-004.mov	0.22 GB	Today, 7:50AM	13s
PIX-E-001-003.mov	0.42 GB	Today, 7:49AM	34s
PIX-E-001-002.mov	0.20 GB	Today, 7:22AM	10s
PIX-E-001-001.mov	0.43 GB	Today, 7:09AM	44s

To view recorded video files:

1. Press the Files soft key button.
2. Turn the Control knob to navigate through the list.
3. Do any of the following:
 - ▶ With a file highlighted, press Play to begin playback of the video.
 - ▶ With a file highlighted, press the Control knob to view its details.

Details provided for each file (if available) are:

- Start Timecode
- Duration
- Created
- Frame rate & Resolution
- Codec
- Audio Format
- Timecode FPS
- User bits
- File size

Deleting Recorded Files

Deleted files are permanently removed from the drive and cannot be restored.

To delete a file:

1. Press the Files soft key button.
2. Turn the Control knob to navigate the list and press it in to select the file you want to delete.
3. Select Delete. An important message appears prompting for confirmation.
4. Select OK to permanently delete the file.
Choosing Cancel exits without file deletion.

Transferring Files to a Computer

QuickTime files on the SpeedDrive may be copied to a computer for post-production editing. These files are compatible with Avid, FinalCut Pro, and Adobe Premier Pro.

To transfer files:

1. Remove the SpeedDrive from the monitor.
2. Insert the SpeedDrive into a USB 3.0 compatible port on the computer.
3. Copy the files to the computer.

Sound Devices, LLC recommends first copying files from the storage device to the computer and then editing the copied files.

- ⚠ *Do not copy video files from a computer (or any other host device) to a drive that is intended to be used by the monitor. If this occurs, it is advisable to re-format the drive with the monitor before making new recordings.***



Recording and Playback

Although the PIX-E5 and PIX-E5H are powerful camera-mount monitors, they also have fully integrated recording capabilities.

Both can record Apple ProRes files and playback the recorded QuickTime files from a SpeedDrive.





① *Sound Devices recommends the camera's output be set to required frame resolution and rate before connecting the camera to the PIX-E monitor.*

Topics in this section include:

- ▶ **Record and Playback Icons**
- ▶ **Recording**
 - ▶ Choosing a Video Input Source
 - ▶ Setting up a Record Trigger
 - ▶ Selecting a Video Codec
 - ▶ Setting PsF Options
 - ▶ FileSafe
 - ▶ Viewing the File List
- ▶ **Playing Back Recorded Files**

Record and Playback Icons

The information bar at the top of the screen displays various information related to the recording process, such as timecode and file names, but it also displays transport status icons. The following table provides a quick reference to these icons.

ICON	STATUS	DESCRIPTION
	Record	The red circle icon is displayed when recording is in progress.
	Stop	The yellow square icon is displayed when recording or playback is stopped.
	Play	The green arrow icon is displayed when playback is in progress.
	Pause	The green pipes icon flashes when playback is paused.

Recording

The PIX-E5 accepts SDI or HDMI signals, and the PIX-E5H accepts only an HDMI signal. Both record Apple ProRes QuickTime files to an attached and formatted SpeedDrive. The SpeedDrive must be formatted by the PIX-E monitor. For formatting instructions, see [Formatting Storage Drives](#).

To start recording:

▶ Press the Rec soft key button.

① *If the transport controls (REC, STOP, PLAY) are not visible, press ALT to switch the soft key buttons to their alternative transport functionality.*

While recording, the OSD will change to indicate recording activity:

- Absolute Time display is red
- Timecode display is red
- Filename display is red
- Red circle icon appears on information bar
- Rec soft key label's background is red
- Drive status display is amber

Also, the LED on the SpeedDrive illuminates amber when the drive is accessed by the monitor.

⚠ *Do not remove the SpeedDrive while its LED is illuminated.*

To stop recording:

▶ Press the Stop soft key button.

When stopped, the Stop soft key label's background is yellow, and a yellow square icon appears in the top left of the information bar.

Choosing a Video Input Source

Selecting which input to use as the video input source is an option on the PIX-E5, since the PIX-E5 features both HDMI and SDI inputs.

To select SDI or HDMI input:

1. Press the MENU button.
2. Select Video I/O > Video Input.
3. Select SDI or HDMI.

① *A best practice tip is to disconnect and reconnect the video input cables whenever changes are made to the input source.*

Setting up a Record Trigger

The PIX-E5 will begin recording when the Rec soft key button is pressed, but it can also start and stop recording automatically when it detects an SDI record trigger from a camera.

① *This feature is not available on the PIX-E5H.*

To set a record trigger:

1. Press the MENU button to access the Main menu.
2. Select Recorder & Drives > Rec Trigger.

3. Select a record trigger.

SETTING	DESCRIPTION
REC button only	Default setting. Record only begins when the Rec soft key is pressed.
SDI Timecode	Recording begins when running timecode is sensed on the SDI input. Recording is stopped when stationary timecode is sensed on the SDI input.
SDI Flag - RED	Various camera manufacturers can trigger recording by sending a specific flag in the SDI signal when the camera is put into record. If you want to trigger the PIX-E5 to record when a camera records, select the option that corresponds to the camera in use.
SDI Flag - Panasonic	
SDI Flag - Panasonic (Varicam)	
SDI Flag - Canon	
SDI Flag - Sony	
SDI Flag - Arri	
SDI Flag - PIX	

Selecting a Video Codec

The PIX-E5 records ProRes video at the same resolution and frame rate as the incoming video signal. Six versions of the ProRes codec are available, ranging from the highest quality ProRes 4444 XQ (12 bit), to the most data-efficient ProRes 422 Proxy (8 bit).

The PIX-E5H records four of the available codecs: ProRes 422 HQ (10 bit), ProRes 422 (10 bit), ProRes 422 LT (8 bit), and ProRes 422 Proxy. Unlike the PIX-E5, the PIX-E5H does not record ProRes 4444 XQ and ProRes 4444.

To select a ProRes codec for recorded files:

1. Press the MENU button.
2. Select Recorder & Drives > Codec.
3. Select a codec.

① *To record using the ProRes 4444 XQ codec, the PIX-E5 must detect a LOG-encoded signal, such as Sony S-log2, over SDI. This is an Apple® requirement.*

Setting PsF Options

Some cameras output signal as progressive segmented frames (PsF). PsF is a method for transmitting progressive content as an interlaced signal. This is useful for playing progressive video on older monitors that do not support 1080 progressive.

PsF signal is identical to interlaced signal in that each frame consists of two fields with one field representing the odd lines of the frame, and the other field representing even lines of the frame. PsF signal differs from interlaced signal in that the two fields are captured at the same moment in time; therefore, there are no interlaced motion artifacts.

By default, if SDI input signal is flagged as PsF, the PIX-E5 will sense this automatically and convert the signal to progressive for display on the monitor. If the 1080i signal from SDI is not flagged as PsF, or if the signal is sent via HDMI, the monitor may be set to interpret the 1080i signal as PsF so that it can convert the signal to progressive.

To interpret 1080i signal as PsF:

1. Press the MENU button.
2. Select Video I/O > Input PsF Detect.
3. Select Interpret 1080i as PsF.

By default, the monitor will record PsF signal as PsF to the file. If PsF-to-progressive conversion is required, the PIX-E5 or PIX-E5H must be set to convert this signal.

To record PsF input signal as progressive:

1. Press the MENU button.
2. Select Video I/O > Input to File Conversion. By default, this is set to Same as Video Input.
3. Select PsF to P.

FileSafe

The PIX-E monitors feature FileSafe™ file-protection. During recording, the monitor writes to a temporary file format with the extension .SDV. When recording is stopped, the file is “finalized” to a standard Quicktime (.MOV) file. The temporary .SDV file format allows for reliable recovery of content in situations where power is lost or a drive is removed during recording. Upon powering up, the monitor will search for any .SDV files on all drives and finalize them to the standard .MOV file format.

① *Using the FileSafe utility, a free download from the Video Devices website, .SDV files can also be recovered to .MOV files from a Mac or Windows computer.*

Viewing the File List

The list of recorded files are available via the SpeedDrive File List screen. The list provides each file’s name, size, the date and time each file was recorded, and each video file’s duration.

To view the SpeedDrive File List:

- ▶ Press the Files soft key button.

① *The SpeedDrive File List screen is not accessible during playback or while recording.*

Playing Back Recorded Files

The PIX-E monitor can only playback Quicktime video files that it recorded. During playback, video is shown on screen and also sent to the monitor's video output(s). The audio signal is also sent to the video output(s) as well as the headphone output.

To play the last file recorded:

- ▶ Press the Play soft key button.

To play a recorded file from the SpeedDrive File List:

1. Press the Files soft key button.

The SpeedDrive File List appears, showing a list of recorded files on the drive.

SpeedDrive File List			
Name	Size	Date	Duration
PIX-E-001-004.mov	0.22 GB	Today, 7:50AM	13s
PIX-E-001-003.mov	0.42 GB	Today, 7:49AM	34s
PIX-E-001-002.mov	0.20 GB	Today, 7:22AM	10s
PIX-E-001-001.mov	0.43 GB	Today, 7:09AM	44s

Play

2. Select a file.
3. Press the Play soft key button.

During playback, the OSD will change to indicate playback activity:

- Absolute Time display is green
- Timecode display is green
- Filename display is green
- Green arrow icon appears on information bar
- Play soft key label's background is green
- Drive status display is amber

① *Recorded files may be deleted from the SpeedDrive. For more information, see [Deleting Recorded Files](#).*

To pause playback:

- ▶ Press the Play soft key button again while playback is in progress.
When playback is paused, the Play soft key label shows the word Pause, its green background flashes, and a green pipes icon flashes on the information bar.
- ▶ Press the Play soft key button resume playback.



Audio

The PIX-E recording field monitors accept either two analog audio inputs or two channels of embedded audio on the HDMI input.

The PIX-E5 also accepts up to eight channels of embedded audio on the SDI input.

Topics in this section include:

- ▶ **Using the Audio Screen**
- ▶ **Setting up Audio Input**
- ▶ **Setting up Tracks**
- ▶ **Configuring Audio Output**
 - ▶ Adjusting Headphone Warning Bell Level

Using the Audio Screen

The Audio screen displays the monitor's audio configuration and serves as an interface to make some changes to the audio setup.

To access the Audio screen:

- ▶ Press the Audio soft key button.

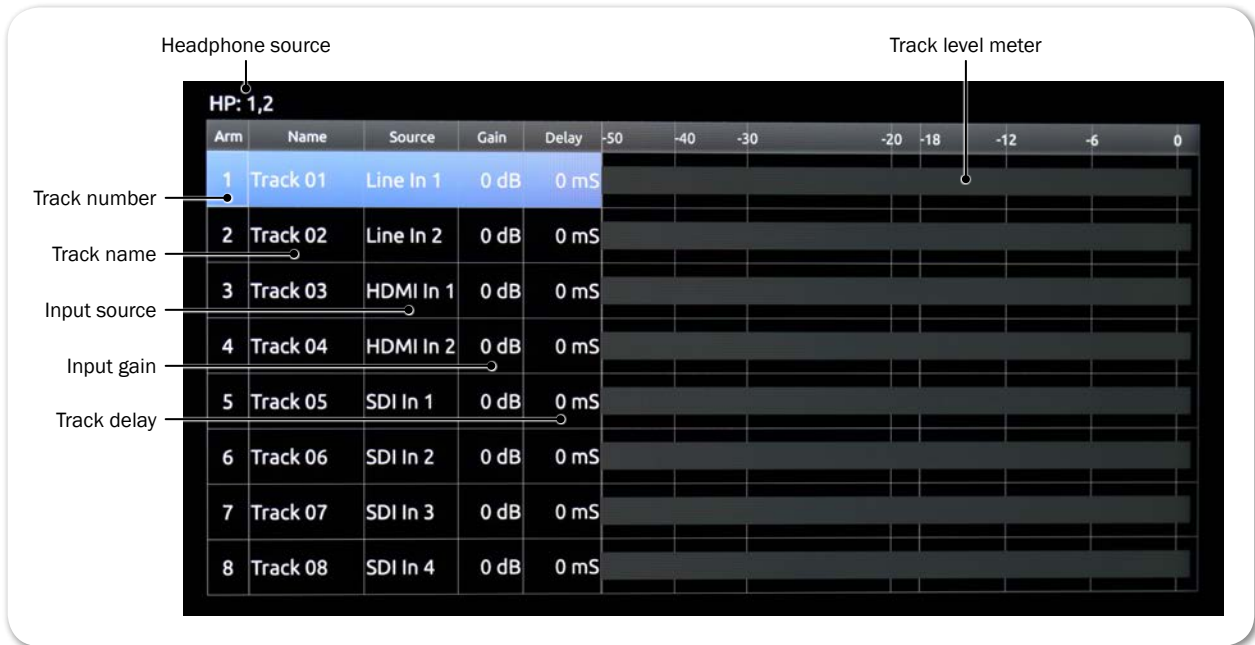

SCREEN ELEMENT	DESCRIPTION
Track number	Displays the number of the track and a color indicating whether the track is armed. Red background: Armed track. Black background: Unarmed track.
Track name	The name of the track.
Input source	The source of the track's input.
Input gain	The input gain value in dB.
Headphone source	The source for headphone output. Left and right channels are separated by a comma. For more information on setting up headphone source, see Configuring Audio Output .
Track level meter	The audio level of the track.

① *The Audio screen is not accessible during playback or while recording.*

Setting up Audio Input

The PIX-E5 can record audio from the SDI input, HDMI input, 3.5 mm stereo line input, and the optional PIX-LR accessory. The PIX-E5H does not have an SDI input, but can record audio from the HDMI input, 3.5 mm stereo line input, and the PIX-LR accessory, if attached.

To set the audio input:

1. From the Audio screen, select the track to adjust.
2. Turn and press the Control knob to select the track's Source field.
3. Select the input source from the list of options, based on the following table, which provides a list of input source options available on either the PIX-E5 or PIX-E5H.

OPTIONS ON THE PIX-E5	OPTIONS ON THE PIX-E5H
Line In 1	Line In 1
Line In 2	Line In 2
XLR 1*	XLR 1*
XLR 2*	XLR 2*
SDI In 1 / HDMI In 1	HDMI In 1
SDI In 2 / HDMI In 2	HDMI In 2
SDI In 3 / HDMI In Off	Off
SDI In 4 / HDMI In Off	
SDI In 5 / HDMI In Off	
SDI In 6 / HDMI In Off	
SDI In 7 / HDMI In Off	
SDI In 8 / HDMI In Off	
Off	* Applies only if PIX-LR accessory is attached

Setting up Tracks

The Audio screen provides the ability to customize track names, set gain levels, adjust input delays, and arm or disarm certain tracks. Use an input delay to align audio with delayed video output from cameras.

To arm or disarm a track:

1. From the Audio screen, select the track to adjust.
2. Turn the Control knob to highlight the track's number field.
3. Press the Control knob to select option to either arm or disarm the track.

① *Additional options include arming or disarming all tracks.*

To edit a tracks' name:

1. From the Audio screen, select the track to adjust.
2. Turn and press the Control knob to edit the track's name field.
3. Use the on-screen keyboard, or attached USB keyboard, to enter the track's new name.
4. Select OK, or press Enter on a USB keyboard, if attached.

To adjust a track's input gain:

1. From the Audio screen, select the track to adjust.
2. Turn and press the Control knob to select the track's Gain field.
3. Adjust the gain in +/- 1 dB increments from -40 dB to +20 dB as needed. The default is 0 dB.
4. Press the Control knob to exit adjustment mode.

To adjust a track’s input delay:

1. From the Audio screen, select the track to adjust.
2. Turn and press the Control knob to select the input delay field.
3. Adjust the input delay in millisecond intervals.
4. Press the Control knob to exit adjustment mode.

Configuring Audio Output

The PIX-E5H outputs audio to its HDMI output. The PIX-E5 outputs audio to both SDI and HDMI outputs.

Audio tracks 1 and 2 are embedded in HDMI output. Audio tracks 1 through 8 are embedded in SDI output.

The monitor also features a 3.5 mm headphone output. The audio source for this output is user-definable.

To choose a headphone source:

1. Press and hold the MENU button for 1 second to access the Monitor menu.
2. Select the HP Source tab.
3. Select a headphone source.

PIX-E5	PIX-E5H	DESCRIPTION
1,2	1,2	Select this stereo option for routing only channel 1 to the left and 2 to the right.
3,4	3,4	Select this stereo option for routing only channel 3 to the left and 4 to the right.
5,6		(PIX-E5 only) Select this stereo option for routing channel 5 to the left and 6 to the right.
7,8		(PIX-E5 only) Select this stereo option for routing channel 7 to the left and 8 to the right.
1357,2468	12,34	Select this stereo option for routing odd channels to the left and even to the right.
12345678	1234	Select this mono option if you want all audio inputs routed to both sides of headphones.
<p><i>① Since the PIX-E5H records up to only 4 channels, the last two options shown above will appear differently in the PIX-E5H: 13,24 for the odd left/even right stereo option and 1234 for the mono option.</i></p>		

To adjust headphone gain:

- ① As a safety precaution, the touch screen is disabled to avoid sudden, accidental changes to headphone gain. Adjustments can only be made using the Control knob.*
1. Press and hold the MENU button for 1 second to access the Monitor menu.
 2. Select the HP Gain tab.

3. Adjust the HP gain, using the Control knob.

Adjusting Headphone Warning Bell Level

A short tone is sent to the headphone output to indicate transport changes (Record start / stop and playback start / stop) or error conditions (Drive missing or drive full). The level of this tone can be adjusted.

To adjust the level of the Headphone Warning Bell:

1. Press the MENU button to access the Main menu.
2. Select Audio > HP Warning Bell Level.
3. Turn the Control knob to adjust the level (-61 to -12 dBFS).



Timecode

PIX-E monitors store timecode metadata within QuickTime files.

The timecode value that is stored is derived from the monitor's internal time-of-day clock, from its internal record run generator, or—for PIX-E5 only—from the external SDI video input.

① *Because the monitor does not include an internal, jammable, free-running generator, it is recommended that the camera utilizes a suitable timecode generator for applications requiring a high level of accuracy.*

Topics in this section include:

- ▶ [Setting a Timecode Mode](#)
- ▶ [Toggling Drop Frame Timecode](#)
- ▶ [Setting the Rec Run Timecode Value](#)

Setting a Timecode Mode

For the PIX-E5H, there are two timecode modes to choose: Time of Day and Record Run. The PIX-E5 offers those two modes plus a third option, external timecode via SDI.

To select a timecode mode:

1. Press the MENU button.
2. Select Timecode > Timecode Mode.
3. Select a timecode mode. Time of Day is the default mode.

OPTION	DESCRIPTION
Ext TC (SDI)	Many cameras are capable of sending timecode along with video signal via SDI. When using external SDI timecode, any user bits present will be stamped to recorded files. This timecode can be used to trigger the monitor to begin recording. For more information, see Setting up a Record Trigger . The PIX-E5's SDI output does not include timecode.
Time of Day	Time of Day timecode mode uses the monitor's internal system clock. When using Time of Day timecode mode, ensure that the system clock is set properly. For more information, see Setting the Date and Time .

OPTION	DESCRIPTION
Record Run	Record Run timecode mode sequentially stamps files with timecode based on the camera's frame rate. Each subsequent recording starts on the timecode value from where the previous recording stopped.

Toggling Drop Frame Timecode

Sometimes a production requires the use of drop frame timecode, and it is necessary to ensure the monitor stamps files as drop frame accordingly.

To toggle drop frame timecode:

1. Press the MENU button.
2. Select Timecode > Drop Frame Enable.
3. Select Off or On.

Setting the Rec Run Timecode Value

Record run timecode mode stamps files sequentially, with the first file being stamped from a specified value. This value is 00:00:00:00 by default, but it can be set to any value. Every time this value is set, the next recording will begin at that value and subsequent recordings will start on the timecode value from where the previous recording stopped.

To set the record run timecode value:

1. Press the MENU button.
2. Select Timecode > Set Rec Run Value.
3. Turn the Control knob to set the highlighted value.
4. Press the Control knob to move to the next value.

System Functions

The Main menu provides access to various system settings related to the date and time, as well as the ability to update firmware and view version information.

Topics in this section include:

- ▶ **Time and Date**
 - ▶ Setting the Date and Time
- ▶ **Updating Firmware**
- ▶ **Checking Version and Serial Number**
- ▶ **Saving and Recalling Settings**
- ▶ **Restoring Factory Default Settings**

Time and Date

The monitor uses the time and date for file properties when writing files to disk. The time and date is also used by the timecode system when the Timecode Mode is set to Time of Day.

SETTING	DESCRIPTION	DEFAULT
Time Format	Selects between 12 or 24 hour format for the time-of-day clock. <ul style="list-style-type: none">• 12h• 24h	12h
Date Format	Selects between MM/DD/YY and DD/MM/YY date format. <ul style="list-style-type: none">• MM/DD/YY• DD/MM/YY	MM/DD/YY
Time Zone	Select the international time zone. <ul style="list-style-type: none">• (All international time zones)	(GMT-06:00) Central Time (US)
Daylight Saving	Toggles daylight saving on or off for the time-of-day clock. <ul style="list-style-type: none">• Off• On	Off
Set Date/Time	Set the date and time.	

Setting the Date and Time

Before setting the date and time, Time Zone and Daylight Saving should be configured properly.

To select a time zone and set daylight saving:

1. Press the MENU button.
2. Select System > Time Zone.
3. Select the correct time zone for your location.
4. Select System > Daylight Saving.
5. Select On or Off.

To set the date and time:

1. Press the MENU button.
2. Select System > Set Date/Time.
3. Turn the Control knob to set the highlighted value.
4. Press the Control knob to move to the next value.

Updating Firmware

Firmware updates are released periodically to improve the functionality and add new features to the monitor. Firmware updates are performed with a .prg file obtained from the Video Devices website.

To update firmware:

1. Download the .prg file to a computer.
2. Connect an SD card or SpeedDrive to the computer.
3. Copy the .prg file to the SD card or SpeedDrive.
4. Remove the SD card or SpeedDrive from the computer and connect it to the monitor.
5. Power up the monitor.

⚠ *Ensure that the monitor is powered via the supplied PIX-E PSU and fully-charged batteries. Power loss during a firmware update can result in the monitor becoming inoperable. In the unlikely event that power is lost during a firmware update, a computer and the USB boot cable, included with the monitor, may be used to reinstall the firmware and recover operation. Contact Customer Support for proper recovery procedures.*

6. Press the MENU button.
7. Select System > Update Firmware.

The monitor will search connected drives for a .prg file. When the .prg file is found, follow the on-screen instructions to perform the firmware update.

- ① *Firmware updates will take several minutes to complete, and the unit will reboot multiple times during the process. Various functions and ports will become inactive while firmware is updating. The monitor is ready to use when it returns to the main display.*
8. (Optional) Verify the firmware version by pressing the MENU button and selecting System > Version Info.

Checking Version and Serial Number

For convenience and support issues, the monitor's firmware version and serial number can be viewed from the Main menu.

To check the firmware version and serial number:

1. Press the MENU button.
2. Select System > Version Info.

A dialog with information is displayed, including the firmware version on the first line and the monitor's serial number at the bottom.

Saving and Recalling Settings

All settings on the monitor can be stored for easy recall at a later time. This is useful for recalling settings for different work flows or projects, or when setting up multiple PIX-E monitors with the same settings.

To save settings to SD card or SpeedDrive:

1. Press the MENU button.
2. Select one of the following:
 - Save/Load Settings > Save Settings to SpeedDrive
 - Save/Load Settings > Save Settings to SD Card
3. Use the on-screen keyboard (Or attached USB keyboard) to enter a name for the settings file.
4. Select OK (Or press Enter on an attached USB keyboard) to save the settings file.

To recall settings from the SD card or SpeedDrive:

1. Press the MENU button.
2. Select one of the following:
 - Save/Load Settings > Load Settings from SpeedDrive
 - Save/Load Settings > Load Settings from SD Card.

3. Select a settings file.

Restoring Factory Default Settings

Should it ever become necessary to restore all settings on the monitor to its original factory defaults, the Main menu provides an option to do that.

⚠ *Restoring defaults will remove all custom modifications to the various monitoring tools.*

To restore factory default settings:

1. Press the MENU button.
2. Select Save/Load Settings > Revert to Factory Settings.

Specifications

This chapter provides specifications for both the PIX-E5 and PIX-E5H monitors. Although the monitors share many features and similarities, there are some differences.

The specifications are provided in separate sections for clarity.

Topics in this section include:

▶ PIX-E5 Specifications

- ▶ Video
- ▶ Audio
- ▶ Storage
- ▶ Timecode
- ▶ Power
- ▶ Physical
- ▶ Environmental

▶ PIX-E5H Specifications

- ▶ Video
- ▶ Audio
- ▶ Storage
- ▶ Timecode
- ▶ Power
- ▶ Physical
- ▶ Environmental

PIX-E5 Specifications

Video

HDMI	Input <ul style="list-style-type: none">• 4:4:4 or 4:2:2, 8/10/12 bit, RGB or YCbCr• Version 1.4a• HDCP enabled	Output <ul style="list-style-type: none">• 4:2:2, 8 bit, YCbCr• Version 1.3
SDI	Input <ul style="list-style-type: none">• 3G-SDI (level A), HD-SDI• 3G-SDI (level B, 1080p30 max)• 4:4:4 or 4:2:2, 8/10/12 bit, RGB or YCbCr• SMPTE 292, and 424	Output <ul style="list-style-type: none">• HD-SDI• 4:2:2, 8 bit, YCbCr• SMPTE 292• Progressive, 30fps max

Supported Input Resolutions and Rates	<ul style="list-style-type: none"> • 4096p30** • 4096p29.97** • 4096p25** • 4096p24** • 4096p23.98** • 3840p30** • 3840p29.97** • 3840p25** • 3840p24** • 3840p23.98** • 1080p60 • 1080p59.94 • 1080p50 • 1080p30 • 1080p29.97 • 1080p25 • 1080p24 • 1080p23.976 • 1080i60 • 1080i59.94 • 1080i50 • 1080PsF30* • 1080PsF29.97* • 1080PsF25* • 1080PsF24* • 1080PsF23.976* • 720p60 • 720p59.94 • 720p50 • 720p30* • 720p29.97* • 720p25* • 720p24* • 720p23.976*
	* SDI only, ** HDMI only
Codecs (Max resolution & frame rate)	<ul style="list-style-type: none"> • Apple ProRes 4444XQ, 12 bit* (1080p30) • Apple ProRes 4444, 12 bit (1080p30) • Apple ProRes 422HQ, 10 bit (4kp30 / 1080p60 / 720p60) • Apple ProRes 422, 10 bit (4kp30 / 1080p60 / 720p60) • Apple ProRes 422LT, 8 bit (4kp30 / 1080p60 / 720p60) • Apple ProRes 422Proxy, 8 bit (4kp30 / 1080p60 / 720p60)
	* SDI Log-encoded inputs only
4K to HD Conversion	4K input to HD output
Input to file conversion	<ul style="list-style-type: none"> • 1080i to PsF • PsF to P
Video I/O conversion	<ul style="list-style-type: none"> • SDI to HDMI • HDMI to SDI
LCD Display	<ul style="list-style-type: none"> • 5-inch In-Plane Switching (IPS) Liquid Crystal Display (LCD) • Gorilla® Glass 2 • Capacitive touch screen • 1920 x 1080 pixel resolution with true 16x9 ratio • 441 ppi • 179° angle of view • 500 nits brightness • 1000:1 contrast ratio

Audio

HDMI	2 channels embedded HDMI input, 2 channels embedded HDMI output
SDI	8 channels embedded SDI input, 8 channels embedded SDI output
Headphone	1/8 in (3.5 mm) TRS with gain control
Line In	1/8 in (3.5 mm) TRS, Unbalanced 2-channel
Sample rate / bit depth	<ul style="list-style-type: none"> • 24-bit • Sample rate synced to active video input (SDI or HDMI). Typically 48 kHz.

Storage

Formats	<ul style="list-style-type: none"> • exFAT drive format (SpeedDrive and SD card) • Quicktime (.mov) video file format (SpeedDrive) • XML setup file format (SpeedDrive and SD card)
---------	--

SpeedDrive™	<ul style="list-style-type: none"> • Internal mSATA Drive • USB 3.0 interface • Dimensions (HxWxD): 3.35 in x 1.5 in x 0.5 in • Weight: 1.2 oz (without drive)
SD card	<ul style="list-style-type: none"> • Types: SD, SDHC, SDXC

① See list of approved media at: www.videodevices.com/approved.

Timecode

Modes Supported	<ul style="list-style-type: none"> • Ext TC (SDI) (RP188) • Time of Day • Rec Run <p>① Start timecode is stamped in the QuickTime file.</p>
Frame Rates	23.976, 24, 25, 29.97DF, 29.97ND, 30DF, 30ND
Inputs	<ul style="list-style-type: none"> • SDI Input BNC

Power

External	External 10-34VDC, threaded coaxial connector (5.5mm outer diameter, 2.1mm inner diameter), pin positive, sleeve negative
Batteries	2x Removable 7.2v (nominal) Sony type L Series Lithium-Ion
Power Draw	12-15W quiescent, depending on settings

Physical

Dimensions (HxWxD)	3.4 in x 5.4 in x 1.6 in (8.6 cm x 13.8 cm x 4.1 cm)
Weight	16 oz (1 lb)

Environmental

Operating Temperature	-10° C to +40° C
-----------------------	------------------

PIX-E5H Specifications

Video

HDMI	<p>Input</p> <ul style="list-style-type: none"> • 4:4:4 or 4:2:2, 8/10/12 bit, RGB or YCbCr • Version 1.4a • HDCP enabled <p>Output</p> <ul style="list-style-type: none"> • 4:2:2, 8 bit, YCbCr • Version 1.3 • 1080p30 or 720p60 max
Supported Input Resolutions and Rates	<ul style="list-style-type: none"> • 4096p30 • 4096p29.97 • 4096p25 • 4096p24 • 4096p23.98 • 3840p30 • 3840p29.97 • 3840p25 • 3840p24 • 3840p23.98 • 1080p60 • 1080p59.94 • 1080p30 • 1080p29.97 • 1080p25 • 1080p24 • 1080p23.976 • 1080i60 • 1080i59.94 • 1080i50 • 720p60 • 720p59.94 • 720p50
Codecs	<ul style="list-style-type: none"> • Apple ProRes 422HQ, 10 bit • Apple ProRes 422, 10 bit • Apple ProRes 422LT, 8 bit • Apple ProRes 422Proxy, 8 bit
4K to HD Conversion	4K input to HD output
Input to file conversion	<ul style="list-style-type: none"> • 1080i to PsF • PsF to P
LCD Display	<ul style="list-style-type: none"> • 5-inch IPS LCD • Gorilla® Glass 2 • Capacitive touch screen • 1920 x 1080 pixel resolution with true 16x9 ratio • 441 ppi • 179° angle of view • 500 nits brightness • 1000:1 contrast ratio

Audio

HDMI	2 channels embedded HDMI input, 2 channels embedded HDMI output
Headphone	1/8 in (3.5 mm) TRS with gain control
Line In	1/8 in (3.5 mm) TRS, Unbalanced 2-channel

Sample rate / bit depth	<ul style="list-style-type: none"> • 24-bit • Sample rate synced to active video input (HDMI). Typically 48 kHz.
-------------------------	--

Storage

Formats	<ul style="list-style-type: none"> • exFAT drive format (SpeedDrive and SD card) • Quicktime (.mov) video file format (SpeedDrive) • XML setup file format (SpeedDrive and SD card)
SpeedDrive™	<ul style="list-style-type: none"> • Internal mSATA Drive • USB 3.0 interface • Dimensions (HxWxD): 3.35 in x 1.5 in x 0.5 in • Weight: 1.2 oz (without drive)
SD card	<ul style="list-style-type: none"> • Types: SD, SDHC, SDXC

① See list of approved media at: www.videodevices.com/approved.

Timecode

Modes Supported	<ul style="list-style-type: none"> • Time of Day • Rec Run <p>① Start timecode is stamped in the QuickTime file.</p>
Frame Rates	23.976, 24, 25, 29.97DF, 29.97ND, 30DF, 30ND

Power

External	External 10-34VDC, threaded coaxial connector (5.5mm outer diameter, 2.1mm inner diameter), pin positive, sleeve negative
Batteries	2x Removable 7.2v (nominal) Sony type L Series Lithium-Ion
Power Draw	12-15W quiescent, depending on settings

Physical

Dimensions (HxWxD)	3.4 in x 5.4 in x 1.6 in (8.6 cm x 13.8 cm x 4.1 cm)
Weight	15.3 oz (0.96 lb)

Environmental

Operating Temperature	-10° C to +40° C
-----------------------	------------------

SOUND DEVICES

Sound Devices, LLC
E7556 Road 23 and 33
Reedsburg, Wisconsin 53959
USA

Phone: +1 (608) 524-0625
Fax: +1 (608) 524-0655

Customer Support

Toll Free: (800) 505-0625

support@sounddevices.com
<http://www.sounddevices.com/support>
<http://forum.sounddevices.com>

Product Information

For more information about products and accessories, visit us on the web at www.sounddevices.com.